

Rules for the Classification of Floating Offshore Units at Fixed Locations and Mobile Offshore Drilling Units

Effective from 1 January 2026

Part A

Classification and Surveys

**GENERAL TERMS AND CONDITIONS
OF EMIRATES CLASSIFICATION SOCIETY – L.L.C – O.P.C (TASNEEF)
EFFECTIVE AS OF 1 APRIL 2025**

DEFINITIONS

Administration	means the government of the state whose flag the Ship is entitled to fly or under whose authority the Ship is authorised to operate in the specific case.
Client	means the interested party and any other party who requires the Services.
Certificate of Classification	means a certificate of classification, issued by a Society and the certificate confirms that the vessel's structure, machinery, and equipment meet the society's specific technical rules and regulations.
Interested Party	means the party, other than the society, having an interest in or responsibility for the Ship, product, plant or system subject to classification or certification (such as the owner of the Ship and his representatives, the Ship builder, the engine builder or the supplier of parts to be tested) who requests the Services or on whose behalf the Services are requested.
Owner	means the registered owner, the Ship owner, the manager or any other party with the responsibility, legally or contractually, to keep the Ship seaworthy or in service, having particular regard to the provisions relating to the maintenance of class laid down in part a, chapter 2 of the rules for the classification of Ships or in the corresponding rules indicated in the specific rules.
Register of Ships	means a register book, also known as a Register of Ships, is a comprehensive record of vessels that are classified by a society.
Rules	means the documents below issued by the Society: <ul style="list-style-type: none"> a. Rules for the classification of Ships or other special units. b. Complementary rules containing the requirements for certification of products, plants, systems and other or containing the requirements for the assignment of additional class notations. c. Rules for the application of statutory rules, containing the rules to perform the duties delegated by administrations. d. Guides to carry out particular activities connected with Services. e. Any other technical document, as for example rule variations or interpretations.

GENERAL TERMS AND CONDITIONS
OF EMIRATES CLASSIFICATION SOCIETY – L.L.C – O.P.C (TASNEEF)
EFFECTIVE AS OF 1 APRIL 2025

DEFINITIONS

Administration	means the government of the state whose flag the Ship is entitled to fly or under whose authority the Ship is authorised to operate in the specific case.
Client	means the interested party and any other party who requires the Services.
Certificate of Classification	means a certificate of classification, issued by a Society and the certificate confirms that the vessel's structure, machinery, and equipment meet the society's specific technical rules and regulations.
Interested Party	means the party, other than the society, having an interest in or responsibility for the Ship, product, plant or system subject to classification or certification (such as the owner of the Ship and his representatives, the Ship builder, the engine builder or the supplier of parts to be tested) who requests the Services or on whose behalf the Services are requested.
Owner	means the registered owner, the Ship owner, the manager or any other party with the responsibility, legally or contractually, to keep the Ship seaworthy or in service, having particular regard to the provisions relating to the maintenance of class laid down in part a, chapter 2 of the rules for the classification of Ships or in the corresponding rules indicated in the specific rules.
Register of Ships	means a register book, also known as a Register of Ships, is a comprehensive record of vessels that are classified by a society.
Rules	means the documents below issued by the Society: <ul style="list-style-type: none"> a. Rules for the classification of Ships or other special units. b. Complementary rules containing the requirements for certification of products, plants, systems and other or containing the requirements for the assignment of additional class notations. c. Rules for the application of statutory rules, containing the rules to perform the duties delegated by administrations. d. Guides to carry out particular activities connected with Services. e. Any other technical document, as for example rule variations or interpretations.

Services	means the activities described in Article 1 below, rendered by the Society upon request made by or on behalf of the Interested Party.
Ship	means ships, boats, craft and other special units, as for example offshore structures, floating units and underwater craft.
Society	means Emirates Classification Society LLC OPC and/or its affiliated entities providing the Services.
Surveyor	means technical staff acting on behalf of the society in performing the Services.
UAE	means United Arab Emirates.

ARTICLE 1

- 1.1 The purpose of the Society is, among others, the classification and certification of Ships and the certification of their parts and components.
- 1.2 The Society (a) sets forth and develops Rules; (b) publishes the Register of Ships; and (c) issues certificates, statements and reports based on its survey activities.
- 1.3 The Society also takes part in the implementation of national and international rules and standards as delegated by various Governments.
- 1.4 The Society carries out technical assistance activities on request and provides special services outside the scope of classification, which is regulated by these general conditions unless expressly excluded in the particular contract.

ARTICLE 2

- 2.1 The Rules developed by the Society reflect the level of its technical knowledge at the time they are published. Therefore, the Society, though committed, also through its research and development services, to continuous updating, does not guarantee they meet state-of-the-art science and technology at the time of publication or that they meet the Society's or others' subsequent technical developments.
- 2.2 The Interested Party is required to know the Rules on the basis of which the Services are provided. With particular reference to Classification Services, special attention is to be given to the Rules concerning class suspension, withdrawal and reinstatement. In case of doubt or inaccuracy, the Interested Party is to promptly contact the Society for clarification. The Rules for Classification of Ships are published on the Society's website: www.tasneefmaritime.ae
- 2.3 The Society exercises due care and skill:
 - (a) in the selection of its Surveyors; and
 - (b) in the performance of its Services, taking into account the level of its technical knowledge at the time the

Services are performed.

- 2.4 Surveys conducted by the Society include, but are not limited to, visual inspection and non-destructive testing. Unless otherwise required, surveys are conducted through sampling techniques and do not consist of comprehensive verification or monitoring of each component of the Ship or of the items subject to certification. The surveys and checks made by the Society, either on board Ships or with remote techniques, do not necessarily require the constant and continuous presence of the Surveyor. The Society may also commission laboratory testing, underwater inspection and other checks to qualified service suppliers, who will carry out these duties under their responsibility. Survey practices and procedures are selected by the Society based on its experience and knowledge and according to generally accepted technical standards in the sector.

ARTICLE 3

- 3.1 The class assigned to a Ship, like the reports, statements, certificates or any other document or information issued by the Society, reflect the discretionary opinion of the Society concerning compliance, at the time the Service is provided, of the Ship or product subject to certification, with the applicable Rules (given the intended use and within the relevant time frame).
- 3.2 The Society is under no obligation to make statements or provide information about elements or facts which are not part of the specific scope of the Service requested by the Interested Party or on its behalf.
- 3.3 No report, statement, notation on a plan, review, Certificate of Classification, document or information issued or given as part of the Services provided by the Society shall have any legal effect or implication other than a representation that, on the basis of the checks made by the Society, the Ship, structure, materials, equipment, machinery or any other item covered by such document or information meet the Rules. Any such document is issued solely for the use of the Society, its committees and clients or other duly authorised bodies and for no other purpose. Therefore, the Society cannot be held liable for any act made or document issued by other parties on the basis of the statements or information given by the Society. The validity, application, meaning and interpretation of a Certificate of Classification, or any other document or information issued by the Society in connection with its Services, are governed by the Rules of the Society, whom is the sole subject entitled to make such authentic interpretation. Any disagreement on technical matters between the Interested Party and the Surveyor in the carrying out of his functions shall be raised in writing as soon as possible with the Society, which will settle any divergence of opinion or dispute.
- 3.4 The classification of a Ship, or the issuance of a certificate or other document connected with classification or certification and in general with the performance of Services by the Society shall have the validity conferred upon it by the Rules of the Society at the time of the assignment of class or issuance of the certificate; in no case shall it amount to a statement or warranty of seaworthiness, structural integrity, quality or fitness for a particular purpose or service of any Ship, structure, material, equipment or machinery inspected or tested by the Society.
- 3.5 Any document issued by the Society in relation to its activities reflects the condition of the Ship or the subject of certification or other activity at the time of the check.
- 3.6 The Rules, surveys and activities performed by the Society, reports, certificates and other documents issued by

the Society are in no way intended to replace the duties and responsibilities of other parties including, without limitation, Governments, designers, ship builders, manufacturers, repairers, suppliers, contractors or sub-contractors, Owners, operators, charterers, underwriters, sellers or intended buyers of a Ship or other product or system surveyed.

- 3.7 These documents and activities do not relieve such parties from any fulfilment, warranty, responsibility, duty or obligation (also of a contractual nature) expressed or implied or in any case incumbent on them, nor do they confer on such parties any right, claim or cause of action against the Society. With particular regard to the duties of the Owner, the Services undertaken by the Society do not relieve the Owner of his duty to ensure proper maintenance of the Ship and ensure seaworthiness at all times. Likewise, the Rules, surveys performed, reports, certificates and other documents issued by the Society are intended neither to guarantee the buyers of the Ship, its components or any other surveyed or certified item, nor to relieve the seller of the duties arising out of the law or the contract, regarding the quality, commercial value or characteristics of the item which is the subject of transaction.
- 3.8 In no case, therefore, shall the Society assume the obligations incumbent upon the above-mentioned parties, even when it is consulted in connection with matters not covered by its Rules or other documents.
- 3.9 In consideration of the above, and within the limits of liability under Article 5 below, the Interested Party undertakes to relieve and hold harmless the Society from any third party claim, as well as from any liability in relation to the latter concerning the Services rendered, where these are attributable to the Interested Party.
- 3.10 Insofar as they are not expressly provided for in these General Conditions, the duties and responsibilities of the Owner and Interested Parties with respect to the Services rendered by the Society are described in the Rules applicable to the specific Service rendered.

ARTICLE 4

- 4.1 Any request for the Society's Services shall be submitted in writing and signed by or on behalf of the Interested Party. Such a request will be considered irrevocable as soon as received by the Society and shall entail acceptance by the applicant of all relevant requirements of the Rules, including these General Conditions. Upon acceptance of the written request by the Society, a contract between the Society and the Interested Party is entered into, which is regulated by the present General Conditions.
- 4.2 In consideration of the Services rendered by the Society, the Interested Party and the person requesting the service shall be jointly liable for the payment of the relevant fees and costs, even if the service is not concluded for any cause not pertaining to the Society. In the latter case, the Society shall not be held liable for non-fulfilment or partial fulfilment of the Services requested. In the event of non-payment of the invoice within the contractually agreed terms, the Society reserves the right to request, in addition to the full payment of the principal amount due and without the need for further formal notice, also:
- (a) Late payment interest at a rate of 5% per annum, calculated from the due date of the invoice until full payment is received, in accordance with the applicable laws in the United Arab Emirates or the country from where the invoice is issued. Any applicable VAT, taxes, or statutory levies shall be borne by the Client as per the laws

of the respective jurisdiction;

- (b) full reimbursement of any costs incurred for debt recovery, including, but not limited to, legal fees, administrative expenses, and the costs of any extrajudicial actions; and
- (c) any additional amount due as compensation for damages suffered as a result of the delay or non-compliance, where documented.

- 4.3 The contract for the classification of a Ship or for other Services may be terminated and any certificates revoked at the request of one of the parties, subject to at least 30 days' notice to be given in writing. Failure to pay, even in part, the fees due for Services carried out by the Society will entitle the Society to immediately terminate the contract and suspend the Services.
- 4.4 The Society may withhold, suspend or withdraw any certificate, report or service in the event of non-payment of fees due to any member of the Society by the Client in relation to the entire business relationship between any member of the Society and the Client or by any other companies belonging to the same group as the Client. This also applies when the obligation to pay rests with a builder or with the Ship's previous Owner.
- 4.5 For every case of termination or suspension of the contract, the fees for the activities performed until the time of the termination or of the suspension shall be owed to the Society as well as the expenses incurred in view of activities already programmed; this is without prejudice to the right to compensation due to the Society as a consequence of the termination or of the suspension.
- 4.6 With particular reference to Ship classification and certification, unless decided otherwise by the Society, termination of the contract implies that the assignment of class to a Ship is withheld or, if already assigned, that it is suspended or withdrawn; any statutory certificates issued by the Society will be withdrawn in those cases where provided for by agreements between the Society and the flag State.

ARTICLE 5

- 5.1 In providing the Services, as well as other correlated information or advice, the Society, its Surveyors, servants or agents operate with due diligence for the proper execution of the activity. However, considering the nature of the activities performed (see Article 2), it is not possible to guarantee absolute accuracy, correctness and completeness of any information or advice supplied. Express and implied warranties are specifically disclaimed.
- 5.2 Therefore, subject to what provided for in Article 5.3 below, and also in the case of activities carried out by delegation of Governments, neither the Society nor any of its Surveyors will be liable for any loss, damage or expense of whatever nature sustained by any person, in tort or in contract, derived from carrying out the Services.
- 5.3 Notwithstanding the provisions in Article 5.1 above, should any user of the Society's Services prove that he has suffered a loss or damage due to any negligent act or omission of the Society, its Surveyors, servants or agents, then the Society will pay compensation to such person for his proved loss, up to, but not exceeding, five times the amount of the fees charged for the specific Services, information or opinions from which the loss or damage derives or, if no fee has been charged, a maximum of AED5,000 (Arab Emirates Dirhams Five Thousand only).
- 5.4 Where the fees charged are related to a number of Services, the amount of the fees will be apportioned for the purpose of the calculation of the maximum compensation, by reference to the estimated time involved in the

performance of the Service from which the damage or loss derives. Any liability for indirect or consequential loss, damage or expense is specifically excluded. In any case, irrespective of the amount of the fees charged, the maximum damages payable by the Society will not be more than AED 300,000 (Three Hundred Thousand Dirhams). Payment of compensation under this Article will not entail any admission of responsibility and/or liability by the Society and will be made without prejudice to the disclaimer clause contained in Article 5.

- 5.5 Any claim for loss or damage of whatever nature by virtue of the provisions set forth herein shall be made to the Society in writing, within the shorter of the following periods: THREE MONTHS from the date on which the Services were performed or THREE MONTHS from the date on which the damage was discovered. Failure to comply with the above deadline will constitute an absolute bar to the pursuit of such a claim against the Society.

ARTICLE 6

- 6.1 Any dispute, controversy, or claim arising out of or relating to these Rules, the Services of the Society, or the interpretation, breach, or termination thereof, shall first be referred to the parties' senior management for amicable resolution within thirty (30) days of written notice by either party.
- 6.2 If the dispute is not resolved amicably under Article 6.1, it shall be exclusively governed by and construed in accordance with the laws of the Emirate of Abu Dhabi and the applicable federal laws of the United Arab Emirates. The courts of Abu Dhabi shall have exclusive jurisdiction to settle any such dispute.

ARTICLE 7

- 7.1 All plans, specifications, documents and information provided by, issued by, or made known to the Society, in connection with the performance of its Services, will be treated as confidential and will not be made available to any other party other than the Owner without authorisation of the Interested Party, except as provided for or required by any applicable legislation from a competent authority. Information about the status and validity of class and statutory certificates, including transfers, changes, suspensions, withdrawals of class, conditions of class, operating conditions or restrictions issued against classed ships and other related information, as may be required, may be published on the website or released by other means, without the prior consent of the Interested Party.
- 7.2 Information about the status and validity of other certificates and statements may also be published on the website or released by other means, without the prior consent of the Interested Party.
- 7.3 Notwithstanding the general duty of confidentiality owed by the Society to its clients in Article 7.1 above, the Society's clients hereby accept that the Society will participate in the IACS Early Warning System which requires each Classification Society to provide other involved Classification Societies with relevant technical information on serious hull structural and engineering systems failures, as defined in the IACS Early Warning System (but not including any drawings relating to the Ship which may be the specific property of another party), to enable such useful information to be shared and used to facilitate the proper working of the IACS Early Warning System. The Society will provide its clients with written details of such information sent to the involved Classification Societies.
- 7.4 In the event of transfer of class, addition of a second class or withdrawal from a double/dual class, the Interested Party undertakes to provide or to permit the Society to provide the other Classification Society with all building plans and drawings, certificates, documents and information relevant to the classed unit, including its history file,

as the other Classification Society may require for the purpose of classification in compliance with the applicable legislation and relative IACS Procedure. It is the Owner's duty to ensure that, whenever required, the consent of the builder is obtained with regard to the provision of plans and drawings to the new Society, either by way of appropriate stipulation in the building contract or by other agreement.

- 7.5 In the event that the ownership of the Ship, product or system subject to certification is transferred to a new subject, the latter shall have the right to access all pertinent drawings, specifications, documents or information issued by the Society or which have come to the knowledge of the Society while carrying out its Services, even if related to a period prior to transfer of ownership.

ARTICLE 8

- 8.1 The Society shall not be obliged to perform any obligation towards the Client (including, without limitation, obligation to (a) perform, deliver, accept, sell, purchase, pay or receive money to, from or through a person or entity, or (b) engage in any other act) if this would be in violation of, inconsistent with or expose the Society to punitive measures under any United Nations resolutions and/or under any laws, regulations, decrees, ordinances, orders, demands, requests, rules or requirements of EU, United Kingdom, and/or United States of America and which relate to foreign trade controls, export controls, embargoes or international boycotts (applying, without limitation, to the financing, payment, insurance, transportation, delivery or storage of product and/or services) hereinafter referred to as "Trade Sanctions".
- 8.2 Recurring the above circumstances during the performance of the contract, the Society shall be entitled at its sole and absolute discretion:
- (a) to immediately suspend payment or performance of the Services which are the object of the contract until such;
 - (b) time as the Trading Sanctions are in force;
 - (c) to a full disengagement from the obligation affected by the Trading Sanctions, in the event that the inability to fulfill the said obligation persists until the term provided for the fulfilment hereunder, provided that where the relevant obligation relates to payments for activities and/or Services which have already been delivered, the affected payment obligation shall remain only suspended until such time as the Trading Sanctions no longer apply to the payment ; and/or
 - (d) to terminate the contract, without prejudice of the Society's rights pursuant to Article 4.

ARTICLE 9

Should any part of these General Conditions be declared invalid, this will not affect the validity of the remaining provisions.

ARTICLE 10

When the Society provides its Services to a consumer - i.e. a natural person who does not act within the scope of his business or professional activity - the following provisions do not apply Article 3 (as far as the Society is solely entitled to the authentic interpretation of the Rules); Article 4, (as far as the payment of the fees is also due for Services not

concluded due to causes not attributable to the Interested Party); Article 5 (as far as the exclusion of liability is concerned), and Article 6 (as far as the jurisdiction of a Board of Arbitrators based in Abu Dhabi is concerned).

ARTICLE 11

- 11.1 The Society and the Interested Party shall promote safety, protect human health and environment and create safe working conditions for their personnel.
- 11.2 The Interested Party shall guarantee that the working environment in which the Society's Surveyor will be required to work is adequate, safe and in all respect compliant with the applicable legislation and Rules and shall adopt all necessary measures to mitigate and/or control any relevant risk.
- 11.3 Furthermore, in accordance with the applicable legislation and Rules, the Interested Party shall provide the Society with complete and detailed information relevant to any actual or potential specific risk existing in the work areas where the Surveyor will be required to operate and relevant to the performance of the Services as well as with any specific safety measure that the Society's Surveyor is requested to comply with.
- 11.4 The Society reserves not to commence and/or to suspend the Services and/or to terminate the contract, claiming compensation for any damage occurred, if it considers that the safety requirements listed in this Article are not satisfactorily met.

EXPLANATORY NOTE TO PART A

1. Reference edition

The reference edition of these Rules is the edition effective from 15 March 2010 issued with Rule Variation TCHU/2010/01 on 23/02/2010.

2. Effective date of the requirements

2.1 All requirements in which new or amended provisions with respect to those contained in the reference edition have been introduced are followed by a date shown in brackets.

The date shown in brackets is the effective date of entry into force of the requirements as amended by the last updating. The effective date of all those requirements not followed by any date shown in brackets is that of the reference edition.

2.2 Item 5 below provides a summary of the technical changes from the preceding edition. In general, this list does not include those items to which only editorial changes have been made not affecting the effective date of the requirements contained therein.

3. Rule Variations and Corrigenda

Until the next edition of the Rules is published, Rule Variations and/or corrigenda, as necessary, will be published on the TASNEEF web site (www.tasneef.ae). Except in particular cases, paper copies of Rule Variations or corrigenda are not issued.

4. Rule subdivision and cross-references

4.1 Rule subdivision

The Rules are subdivided into six parts, from A to F.

Part A: Classification and Surveys

Part B: Hull and Stability

Part C: Machinery, Systems and Fire Protection

Part D: Materials and Welding

Part E: Service Notations

Part F: Additional Class Notations

Each Part consists of:

- Chapters
- Sections and possible Appendices
- Articles
- Sub-articles
- Requirements

Figures (abbr. Fig) and Tables (abbr. Tab) are numbered in ascending order within each Section or Appendix.

5.2 Cross-references

Examples: Pt A, Ch 1, Sec 1, [3.2.1] or Pt A, Ch 1, App 1, [3.2.1]

- Pt A means Part A

The part is indicated when it is different from the part in which the cross-reference appears. Otherwise, it is not indicated.

- Ch 1 means Chapter 1

The Chapter is indicated when it is different from the chapter in which the cross-reference appears. Otherwise, it is not indicated.

- Sec 1 means Section 1 (or App 1 means Appendix 1)

The Section (or Appendix) is indicated when it is different from the Section (or Appendix) in which the cross-reference appears. Otherwise, it is not indicated.

- [3.2.1] refers to requirement 1, within sub-article 2 of article 3.

Cross-references to an entire Part or Chapter are not abbreviated as indicated in the following examples:

- Part A for a cross-reference to Part A
- Part A, Chapter 1 for a cross-reference to Chapter 1 of Part A.

5. Summary of amendments

Foreword

The date of entry into force of each new or amended item is shown in brackets after the number of the item concerned.

RULES FOR THE CLASSIFICATION OF FLOATING OFFSHORE UNITS AT FIXED LOCATIONS AND MOBILE OFFSHORE DRILLING UNITS

Part A Classification and Surveys

Chapters **1 2 3 4 5**

Chapter 1	PRINCIPLES OF CLASSIFICATION AND CLASS NOTATIONS
Chapter 2	ASSIGNMENT, MAINTENANCE, SUSPENSION AND WITHDRAWAL OF CLASS
Chapter 3	SCOPE OF SURVEYS (all units)
Chapter 4	SCOPE OF SURVEYS IN RESPECT OF THE DIFFERENT SERVICES OF UNITS
Chapter 5	SCOPE OF SURVEYS RELATED TO ADDITIONAL CLASS NOTATIONS

CHAPTER 1

PRINCIPLES OF CLASSIFICATION AND CLASS NOTATIONS

Section 1 General Principles of Classification

1	Principles of classification	22
1.1	Purpose of the Rules	
1.2	General definitions	
1.3	Meaning of classification, scope and limits	
1.4	Request for services	
1.5	Register of ships	
2	Rules	24
2.1	Equivalence	
2.2	Effective date	
2.3	Conversion	
2.4	Novel features	
2.5	Interpretation	
2.6	Disagreement and appeal	
3	Duties of the Interested Parties	25
3.1	International and national regulations	
3.2	Surveyor's intervention	
3.3	Operation and maintenance of units	
3.4	Flag State and Coastal State inspections	
3.5	Use of measuring equipment and of service suppliers	
3.6	Spare parts	

Section 2 Classification Notations

1	General	28
1.1	Purpose of the classification notations	
1.2	Types of notations assigned	
1.3	Modes of operation	
2	Main class symbol	28
2.1	Main class symbol	
3	Construction marks	28
3.1	General	
3.2	List of construction marks	

4	Service notations	29
<hr/>		
	4.1 General	
	4.2 FSO	
	4.3 FPSO	
	4.4 FPU	
	4.5 FSRU	
	4.6 MODU	
	4.7 FLNG	
	4.8 MOSU	
	4.9 Special service	
	4.10 Additional service feature CSR	
	4.11 Additional service feature Crane	
	4.12 Additional service feature Assisted Propulsion	
	4.13 Additional service feature Propulsion Assist	
5	Navigation, transfer and operating area notations	31
<hr/>		
	5.1 Navigation notation	
	5.2 List of navigation notations	
	5.3 Transfer notation	
	5.4 Specified operating area notation	
6	Additional class notations	32
<hr/>		
	6.1 General	
	6.2 Automated machinery systems (AUT)	
	6.3 Monitoring equipment (MON)	
	6.4 Comfort on board units (COMF)	
	6.5 Pollution prevention	
	6.6 Navigation in ice (ICE CLASS)	
	6.7 Navigation in ice (POLAR CLASS)	
	6.8 WINTERIZATION (temp)	
	6.9 Planned maintenance scheme and condition based maintenance (PMS/CBM)	
	6.10 Other additional class notations	
7	Other notations	34
<hr/>		
	7.1	

CHAPTER 2

ASSIGNMENT, MAINTENANCE, SUSPENSION AND WITHDRAWAL OF CLASS

Section 1 Assignment of Class

1	General	38
	1.1 Main cases of assignment of class	
2	New building procedure	38
	2.1 Units surveyed by the Society during construction	
	2.2 Other cases	
	2.3 Documentation	
	2.4 Assignment of Double Class to a unit surveyed during construction by two Societies	
	2.5 Assignment of a Dual Class to a unit surveyed during construction by two QSCS Classification Societies and in full compliance with all applicable and relevant IACS Resolutions (IACS PR 1B)	
3	Units classed after construction	40
	3.1 General	
	3.2 Transfer to the Society's class of a unit in service classed by another QSCS Classification Society (IACS PR 1A)	
	3.3 Transfer to the Society's class of a unit surveyed during construction by another IACS Society at unit's delivery (IACS PR 1A)	
	3.4 Addition of the Society's class to a unit in service classed by another a QSCS Classification Society (IACS PR1B)	
	3.5 Addition of the Society's class to a unit surveyed during construction by another QSCS Classification Society at the unit's delivery (IACS PR1B)	
	3.6 Units in service not classed with a QSCS Society or not classed at all (PR1D)	
4	Date of initial classification	47
	4.1 Definitions	
5	Reassignment of class	47
	5.1 Units in service classed by a QSCS Classification Society	
	5.2 Units in service not classed by an IACS Society	
	5.3 Units in service not classed by a QSCS Classification Society, but previously classified by a QSCS Classification Society	
	5.4 Units no longer in service since class withdrawal by the Society	
	5.5 Units no longer in service since class withdrawal by a QSCS Classification Society or by a non-QSCS Classification Society	
6	Double or dual class procedure	48
	6.1 Definitions	
	6.2 Procedure	

Section 2 Maintenance of Class

1	General principles of surveys	50
1.1	Survey types	
1.2	Change of periodicity, postponement or advance of surveys	
1.3	Extension of scope of survey	
1.4	General procedure of survey	
1.5	Appointment of another Surveyor	
2	Definitions and procedures related to surveys	51
2.1	General	
2.2	Terminology related to hull survey	
2.3	Procedural requirements for thickness measurements	
2.4	Agreement of firms for in-water survey	
2.5	Conditions for surveys	
2.6	Surveys by use of a Remote Inspection Technique (RIT)	
2.7	Access to structures	
2.8	Equipment for surveys	
2.9	Rescue and emergency response equipment	
2.10	Procedure of survey	
2.11	Repairs and maintenance during operation	
2.12	Prompt and thorough repairs	
2.13	Planned survey program	
2.14	Procedure for imposing and clearing recommendations	
3	Certificate of Classification: issue, validity, endorsement and renewal	58
3.1	Issue of Certificate of Classification	
3.2	Validity of Certificate of Classification, maintenance of class	
3.3	Endorsement of Certificate of Classification	
3.4	Status of surveys and recommendations	
4	Class renewal survey	59
4.1	General principles	
4.2	Normal system	
4.3	Continuous survey system	
4.4	Planned maintenance scheme (PMS/CBM) for machinery	
5	Other periodical surveys	60
5.1	General	
5.2	Annual surveys	
5.3	Intermediate surveys	
5.4	Bottom survey	
5.5	Survey of propulsion systems	
5.6	Boiler survey	
5.7	Links between anniversary dates and annual surveys, intermediate surveys and class renewal surveys	
6	Occasional surveys	62
6.1	General	
6.2	Damage and repair surveys	
6.3	Conversions, alterations and repairs	
6.4	Quality System audits	
7	Change of ownership	62
7.1		
8	Lay-up and re-commissioning	62
8.1	General principles	

9	Possible safety management system failures	63
	9.1	

Section 3 Suspension and Withdrawal of Class

1	General	64
	1.1 Discontinuance of class	
	1.2 Suspension of class	
	1.3 Withdrawal of class	
	1.4 Reassignment of class following class withdrawal	
	1.5 Suspension/withdrawal of additional class notations	

Appendix 1 CMS and PMS: Surveys Carried Out by the Chief Engineer

1	Documentation	67
	1.1	
2	Limits of the interventions	67
	2.1	
3	Procedure for carrying out surveys	67
	3.1 General	
	3.2 Main diesel engines	
	3.3 Auxiliary diesel engines	
	3.4 Reciprocating compressors	
	3.5 Coolers, condensers, heaters	
	3.6 Electrical switchboard	
	3.7 a.c. and d.c. generators	
	3.8 Other items (pumps, electric motors, etc.)	
4	Records of surveys carried out	68
	4.1	
5	Confirmatory survey	69
	5.1	
6	Suspension of the Chief Engineer's authorisation	69
	6.1	

Appendix 2 Thickness Measurements: Extent, Determination of Locations and Acceptance Criteria

1	General	70
	1.1 Aim of the Appendix	
	1.2 Scope of the Appendix	
2	Rule requirements for the extent of measurements	70
	2.1 General	
	2.2 Class renewal survey for all units	
3	Number and locations of measurements	70
	3.1 General	
	3.2 Locations of points	

4	Acceptance criteria for thickness measurements	70
4.1	General	
4.2	Criteria	
4.3	Local and global strength criteria	
4.4	Buckling strength criterion	
4.5	Pitting	

Appendix 3 Criteria for Longitudinal Strength of the Hull Girder

1	General	84
1.1		
2	Calculation of transverse sectional areas of deck and bottom flanges of hull girder	84
2.1		
3	Requirements for transverse section modulus of hull girder	84
3.1		
4	Calculation criteria of section moduli of midship section of hull girder	84
4.1		
5	Diminution limit of minimum longitudinal strength of units in service	85
5.1		
6	FPSOs and FSOs - Sampling method of thickness measurements longitudinal strength evaluation and repair methods	for 85
6.1	Extent of longitudinal strength evaluation	
6.2	Sampling method of thickness measurement	
6.3	Additional measurements where the longitudinal strength is deficient	
6.4	Effective repair methods	

CHAPTER 3

SCOPE OF SURVEYS (ALL UNITS)

Section 1 Survey for New Construction

1	Hull	90
	1.1 Plans and documents	
	1.2 Materials	
	1.3 Formal safety case	
2	Survey during construction	90
	2.1 Special survey	
	2.2 Special surveys of facultative plants / systems	
	2.3 Surveys of Watertight Cable Transits	
3	Assignment of double or dual class for New Construction	90
	3.1 Assignment of double class for New Construction	
	3.2 Assignment of dual class for New Construction	

Section 2 Survey for Assignment of Class of a Unit in Service

1	Surveys required by IACS Procedural Requirement PR 1A	93
	1.1 Transfer to the Society's class of a unit in service classed by another QSCS Classification Society and in full compliance with all applicable and relevant IACS Resolutions	
	1.2 Transfer to the Society's class of a unit surveyed during construction by another QSCS Classification Society and in full compliance with all applicable and relevant IACS Resolutions, at unit's delivery	
2	Surveys required by IACS Procedural Requirement PR 1B	94
	2.1 Addition of the Society's class to a unit in service classed by another QSCS Classification Society and in full compliance with all applicable and relevant IACS Resolutions	
	2.2 Addition of the Society's class to a unit surveyed during construction by another QSCS Classification Society and in full compliance with all applicable and relevant IACS Resolutions, at unit's delivery	
3	Surveys required by IACS Procedural Requirement PR1D	94
	3.1 Units in service classed with a QSCS Classification Society but not in full compliance with all applicable and relevant IACS Resolution or not classed with a QSCS Classification Society or not classed at all	
4	Reassignment of Class	95
	4.1 Conditions for reassignment Surveys	

Section 3 Annual Survey

1	General	96
	1.1	
2	Hull	96
	2.1 Scope	

3	Hull	96
	3.1	Hull, structure and equipment
	3.2	Ballast tanks
	3.3	Suspect areas
	3.4	Turrets
	3.5	Positional mooring system
	3.6	Watertight Cable Transits
4	Machinery and systems	98
	4.1	General machinery installations
	4.2	Boilers
	4.3	Electrical machinery and equipment
	4.4	Swivel stack
5	Safety and communication systems and hazardous areas	99
	5.1	
6	Import/Export systems	99
	6.1	

Section 4 Intermediate Survey

1	General	102
	1.1	
2	Hull and machinery requirements	102
	2.1	
	2.2	Turret

Section 5 Class Renewal Survey

1	General	103
	1.1	
2	Hull and hull equipment	103
	2.1	Bottom survey
	2.2	Decks, hatch covers and equipment
	2.3	Holds and other dry compartments
	2.4	Tanks
	2.5	Thickness measurements
	2.6	Turrets and mooring
	2.7	Positional mooring systems
	2.8	Watertight Cable Transits
3	Machinery and systems	108
	3.1	General
	3.2	Main and auxiliary engines and turbines
	3.3	Reduction gears, main thrust and intermediate shaft(s)
	3.4	Pumps and other machinery items
	3.5	Systems in machinery spaces
	3.6	Electrical equipment and installations
	3.7	Controls
	3.8	Fire protection, detection and extinction

4	Import/Export systems	111
	4.1	

Section 6 Bottom Survey

1	General	113
	1.1	
2	Bottom survey in dry condition	113
	2.1 General requirements	
	2.2 Bottom survey held within the scope of class renewal survey	
3	Bottom in-water survey	113
	3.1 General	

Section 7 Shaft Survey

1	Survey of shafts	115
	1.1 General	
2	Periodical survey of other propulsion systems	115
	2.1 Rotating and azimuth thrusters	
	2.2 Vertical axis propellers	
	2.3 Pump jet systems	

Section 8 Boiler Survey

1	Steam boilers	117
	1.1	
2	Thermal oil heaters	117
	2.1	

Appendix 1 Class Requirements and Surveys of Laid-up Units

1	General	119
	1.1	
2	Safety conditions	119
	2.1	

3	Preservation measures for lay-up and maintenance	119
<hr/>		
	3.1 General	
	3.2 Exposed parts of the hull	
	3.3 Internal spaces	
	3.4 Deck fittings	
	3.5 Machinery	
	3.6 Electrical installations	
	3.7 Steering gear	
	3.8 Boilers	
	3.9 Automation equipment	
	3.10 Mooring system	
4	Lay-up site and mooring arrangements	122
<hr/>		
	4.1 General	
	4.2 Recommendations for the lay-up site	
	4.3 Recommendations for the mooring arrangements	
	4.4 Review of the mooring arrangements	
5	Surveys	123
<hr/>		
	5.1 Laying-up survey	
	5.2 Annual lay-up condition survey	
	5.3 Re-commissioning survey	

CHAPTER 4

SCOPE OF SURVEYS IN RESPECT OF THE DIFFERENT SERVICES OF UNITS

Section 1 General

1	General	128
1.1		
2	Service notations subject to additional surveys	128
2.1		

Section 2 FSO and MOSU

1	General	129
1.1	Application	
2	Annual survey - Hull items	129
2.1	General	
2.2	Cargo pump rooms and pipetunnel	
2.3	Ballast tanks	
3	Annual survey - Cargo machinery items	129
3.1	Cargo area and cargo pump rooms	
3.2	Instrumentation and safety devices	
3.3	Inert gas system	
3.4	Fire protection, detection and extinction	
4	Intermediate survey - Hull items	131
4.1	Weather decks	
4.2	General	
4.3	MOSU between 5 and 10 years of age	
4.4	Units between 10 and 15 years of age	
4.5	Units over 15 years of age	
5	Intermediate survey - Cargo machinery items	131
5.1	Cargo area and cargo pump rooms	
5.2	Inert gas system	
6	Class renewal survey - Hull items	131
6.1	Planned survey program	
6.2	Scope of survey	
6.3	Overall and close-up surveys	
6.4	Thickness measurements	
6.5	Tank testing	
6.6	Cargo area and cargo pump rooms	
7	Class renewal survey - Cargo machinery items	142
7.1	Cargo area and cargo pump rooms	
7.2	Inert gas system	

Section 3 FPSO and FPU

1	General	144
	1.1 Application	
2	Annual survey - Hull items	144
	2.1 General	
	2.2 Cargo pump rooms and pipetunnel	
	2.3 Ballast tanks	
3	Annual survey - Cargo machinery items	144
	3.1 Cargo area and cargo pump rooms	
	3.2 Instrumentation and safety devices	
	3.3 Inert gas system	
	3.4 Fire protection, detection and extinction	
4	Annual survey - Production and process installations	146
	4.1 Fire protection, detection and extinction	
	4.2 Production and process installation	
5	Intermediate survey - Hull items	147
	5.1 Weather decks	
	5.2 General	
	5.3 Units between 10 and 15 years of age	
	5.4 Units over 15 years of age	
6	Intermediate survey - Cargo machinery items	147
	6.1 Cargo area and cargo pumprooms	
	6.2 Inert gas system	
7	Class renewal survey - Hull items	147
	7.1 Planned survey program	
	7.2 Scope of survey	
	7.3 Overall and close-up surveys	
	7.4 Thickness measurements	
	7.5 Tank testing	
	7.6 Cargo area and cargo pumprooms	
8	Class renewal survey - Cargo machinery items	157
	8.1 Cargo area and cargo pumprooms	
	8.2 Inert gas system	
9	Class renewal survey - Production and process installations	158
	9.1	

Section 4 FSRU

1	General	159
	1.1 Application	
2	Annual survey - Hull items	159
	2.1 Scope	

3	Annual survey - Cargo installations items	159
	3.1 General	
	3.2 Weather decks and cargo handling rooms	
	3.3 Other arrangements or devices	
	3.4 Cargo area, cargo compressor rooms, cargo pump rooms	
	3.5 Instrumentation and safety devices	
	3.6 Inert gas/air drying systems	
4	Intermediate survey - Hull items	161
	4.1 Scope	
5	Intermediate survey - Cargo installation items	162
	5.1 General	
	5.2 Weather decks and cargo handling rooms	
	5.3 Cargo area, cargo pump rooms, cargo compressor rooms	
	5.4 Instrumentation and safety devices	
	5.5 Inert gas system	
6	Class renewal survey - Hull items	163
	6.1 Planned survey program	
	6.2 Scope of survey	
	6.3 Extent of overall and close-up surveys	
	6.4 Extent of thickness measurements	
	6.5 Extent of tank testing	
7	Class renewal survey - Cargo installation items	165
	7.1 General	
	7.2 Cargo containment	
	7.3 Piping systems	
	7.4 Cargo area, cargo pump rooms, cargo compressor rooms	
	7.5 Inert gas system/air drying system	

Section 5 MODU

1	General	170
	1.1 Application	
2	Annual survey - Hull items	170
	2.1 Hull, structure and weather decks	
3	Annual survey - Machinery items	171
	3.1	
	3.2 Fire protection, detection and extinction	
4	Class renewal survey - Hull items	171
	4.1 Planned survey program	
	4.2 Scope of survey	
	4.3 Overall and close-up surveys	
	4.4 Thickness measurements	
	4.5 Tank testing	
5	Class renewal survey - Machinery items	172
	5.1 Pumps and valves	
	5.2 Electrical installations and ventilation systems	

6	Bottom survey - Additional requirements for MODU	173
6.1	Docking survey	
6.2	Underwater survey	
7	Survey of propulsion systems	173
7.1	Periodical survey of other propulsion systems	

Section 6 FLNG

1	General	177
1.1	Application	
2	All surveys - Hull and cargo installation items	177
2.1	General	
2.2	Liquefaction plants	

Section 7 SPECIAL SERVICE

1	General	178
1.1		

CHAPTER 5

SCOPE OF SURVEYS RELATED TO ADDITIONAL CLASS NOTATIONS

Section 1 General

1	General	182
	1.1	
2	Additional class notations subject to additional surveys	182
	2.1	

Section 2 Automated Machinery Systems

1	General	184
	1.1	
2	Annual survey	184
	2.1	
3	Class renewal survey	184
	3.1	

Section 3 Monitoring Equipment

1	General	185
	1.1 Application	
2	MON-HULL	185
	2.1 Annual and class renewal survey	

Section 4 Pollution Prevention (Green Plus)

1	General	186
	1.1 Application	

Section 5 Helideck

1	General	188
	1.1 Application	
2	Annual survey	188
	2.1	
3	Class renewal survey	189
	3.1	

Section 6 Drilling Systems

1	General	190
	1.1 Application	
2	Annual survey	190
	2.1	
3	Class renewal survey	191
	3.1	

Section 7 Other Notations

1	General	192
	1.1	
2	DYNAPOS	192
	2.1 Annual survey	
	2.2 Class renewal survey	
3	VCS	192
	3.1 Annual survey	
	3.2 Class renewal survey	
	3.3 Class renewal survey	
4	CARGOCONTROL	193
	4.1 Annual survey	
	4.2 Class renewal survey	
5	COAT-WBT	193
	5.1 General	
	5.2 Intermediate and class renewal surveys	
	5.3 Coating damage and repairs	
6	DIVINGSUPPORT	193
	6.1 Annual survey	
	6.2 Class renewal survey	
7	HVSC	194
	7.1 Annual and class renewal survey	
8	TAS	194
	8.1 Annual survey	
9	ARS	194
	9.1 Annual survey	
	9.2 Renewal survey	

Part A
Classification and Surveys

Chapter 1

**PRINCIPLES OF CLASSIFICATION AND CLASS
NOTATIONS**

SECTION 1 GENERAL PRINCIPLES OF CLASSIFICATION

SECTION 2 CLASSIFICATION NOTATIONS

SECTION 1

GENERAL PRINCIPLES OF CLASSIFICATION

1 Principles of classification

1.1 Purpose of the Rules

1.11 The Rules published by the Society give the requirements for the assignment and the maintenance of class for floating offshore units at fixed locations and mobile offshore units.

Class assigned to a unit reflects the discretionary opinion of the Society that the unit, for declared conditions of use and within the relevant time frame, complies with the Rules applicable at the time the service is rendered.

Note 1: The general conditions of classification are laid down in the "General Conditions" placed at the beginning of these Rules.

1.12 The present Rules are subdivided into the following Parts:

- Part A - Classification and Surveys
- Part B - Hull and Stability
- Part C - Machinery, Electrical installations, Automation and Fire Protection
- Part D - Materials and Welding
- Part E - Service Notations
- Part F - Additional Class Notations (applied at the request of the Interested Party).

Part E contains the requirements applicable depending on the service notation assigned to the unit, in addition to or, where explicitly indicated in the same Part E, in replacement of those in Parts B, C and D.

1.13 Those statutory requirements regarding fire protection, detection, extinction that are not covered by classification (see Part C, Chapter 4) become matter of class where the Society carries out surveys relevant to fire protection statutory requirements on behalf of the flag Administration.

1.2 General definitions

1.2.1 (1/7/2023)

The following general definitions are used in these Rules:

- a) Society means TASNEEF and or all the companies in the TASNEEF Group which provide the services
- b) Rules means these Rules for floating offshore units at a fixed location and mobile offshore drilling units (MODU's) as well as documents issued by the Society serving the same purpose
- c) Floating unit means a unit permanently moored on the site by means of a fixed or disconnectable mooring system and intended for the storage, production and off-loading of hydrocarbons including liquefied natural gas (LNG) and liquefied petroleum gas (LPG). Floating units can be either non-self-propelled or propelled.
- d) MODU means a mobile offshore drilling unit or other similar units
- e) Unit means either a floating unit or a MODU
- f) Common Structural Rules means the "Common Structural Rules for Double Hull Oil Tankers" adopted by IACS
- g) Surveyor means technical staff acting on behalf of the Society to perform tasks in relation to classification and survey duties
- h) Survey means an intervention by the Surveyor for assignment or maintenance of class as defined in Chapter 2, or interventions by the Surveyor within the limits of the tasks delegated by the Administrations.
- i) Administration means the Government of the State whose flag the unit is entitled to fly.
- j) Coastal State Authority is the Authority responsible for the safety standards of units operating in or adjacent to their territorial waters.
- k) Interested Party means a party, other than the Society, having responsibility for the classification of the unit, such as the Owner of the unit and his representatives, or the Shipbuilder, or the Engine Builder, or the Supplier of parts to be tested.
- l) QSCS Classification Society means a Classification Society which is subject to verification of compliance with the IACS Quality System Certification Scheme (QSCS).
- m) Owner, in the context of these Rules, is defined as the party responsible for the installation, operation and safety of the unit.
- n) Approval means the examination and acceptance by the Society of documents, procedures or other items related to classification, verifying solely their compliance with the relevant Rules requirements, or other references where requested.
- o) Type approval means an approval process for verifying compliance with the Rules of a product, a group of products or a system, and considered by the Society as representative of continuous production.
- p) Essential service is intended to mean a service necessary for a unit to proceed at sea, be steered or manoeuvred, or undertake activities connected with its operation, and for the safety of life, as far as class is concerned.
- q) Site means the geographical location where the unit is permanently moored in order to carry out the design activity.

- r) Sea depth means the vertical distance between the seabed and the minimum level of the water, taking into account the (possibly combined) effects of the astronomical, barometric and Aeoliantides.
- s) Design activity means the industrial activity (production of hydrocarbons, storage and transfer, etc.) or similar, carried out by the unit, for which the latter has been designed and classed.
- t) Shuttle means the ship which carries out the periodical off-loading of the hydrocarbon stored by the unit.
- u) Mooring system means the system which permanently moors the unit to the site, fixing it to the seabed by means of piles, anchors or gravity.

1.3 Meaning of classification, scope and limits

131 The classification consists of:

- a) the development of Rules, guides and other documents relevant to the unit, structure, material, equipment, machinery and any other item covered by such documents
- b) the examination of plans and calculations and the surveys, checks and tests intended to ensure that the unit meets the Rules (refer to Ch 2, Sec 1)
- c) the assignment of class (see Ch 2, Sec 1) and issue of a Certificate of Classification, where the above Rules are met
- d) the periodical, occasional and class renewal surveys performed to verify that the unit in service meets the conditions for maintenance of class (see Ch 2, Sec 2).

132 The Rules, surveys performed, reports, certificates and other documents issued by the Society, are in no way intended to replace or alleviate the duties and responsibilities of other parties such as Administrations, Designers, Shipbuilders, Manufacturers, Repairers, Suppliers, Contractors or Sub-contractors, actual or prospective Owners or Operators, Charterers, Brokers, Cargo-owners and Underwriters. The Society cannot therefore assume the obligations arising from these functions, even when the Society is consulted to answer inquiries concerning matters not covered by its Rules, or other documents.

The activities of such parties which fall outside the scope of the classification as set out in the Rules, such as design, engineering, manufacturing, operating alternatives, choice of type and power of machinery and equipment, number and qualification of crew or operating personnel, lines of the unit, trim, hull vibrations, spare parts including their number, location and fastening arrangements, life-saving appliances, and maintenance equipment, remain therefore the responsibility of those parties, even if these matters may be given consideration for classification according to the type of unit or additional class notation assigned.

The classification-related services and documents performed and issued by the Society do not relieve the parties concerned of their responsibilities or other contractual obligations expressed or implied or of any

liability whatsoever, nor do they create any right or claim in relation to the Society with regard to such responsibilities, obligations and liabilities. In particular the Society does not declare the acceptance or commissioning of a unit or any part of it, this being the exclusive responsibility of the Owner.

Unless otherwise specified, the Rules do not deal with structures, pressure vessels, machinery and equipment which are not permanently installed and used solely for operational activities such as heavy load lifting, workshops or welding equipment, except for their effect on the classification-related matters, as declared by the Interested Party, such as fire protection and unit's general strength.

During periods of construction, modification or repair, the unit is solely under the responsibility of the builder or the repair yard. As an example, the builder or repair yard is to ensure that the construction, modification or repair activities are compatible with the design strength of the unit and that no permanent deformations are sustained.

Note 1: Refer to [3.3] as regards the Owner's responsibility for maintenance and operation of the unit in relation to the maintenance of class.

133 Scope of classification (1/1/2011)

The classification of the units covers the following:

- a) the materials used and their relevant connections
- b) the structural strength
- c) the intact stability. Damage stability, except for Modu, is not an item of class, but, upon request of the Interested Party the additional class notation DMS may be assigned to units complying with the requirements given in Pt F, Ch 6, Sec 5
- d) the watertightness and the weathertightness
- e) the unit anchoring system to the sea bed
- f) the unit mooring system for the shuttle to the unit
- g) the helicopter deck
- h) the machinery, equipment and piping needed for the operation of the unit, the ship to ship transfer on board of non-processed hydrocarbons and discharge of processed hydrocarbons including loading arms and hoses, as applicable; items located outside the unit boundaries are not covered by classification
- i) fire protection, as specified in Part C, Chapter 4
- j) the system of protection against corrosion, as specified in Part D.

1.4 Request for services

141 Requests for interventions by the Society, such as surveys during construction, surveys of units in service, tests, etc., are in principle to be submitted in writing and signed by the Interested Party. Such request implies that the applicant will abide by all the relevant requirements of the Rules, including its "General Conditions".

The Society reserves the right to refuse or withdraw the class of any unit for which any applicable requirement of the Rules is not complied with.

1.5 Register of ships

151 A Register of Ships is published periodically by the Society. This publication, which is updated by the Society, contains the names of units which have received the Certificate of Classification, as well as particulars of the class assigned and information concerning each unit.

2 Rules

2.1 Equivalence

2.1.1 The Society may consider the acceptance of alternatives to these Rules, provided that they are deemed to be equivalent to the Rules to the satisfaction of the Society.

2.2 Effective date

2.2.1 The effective date of entry into force of any amendments to the Rules is indicated on the inside front page of each Part of the Rules.

2.2.2 In principle, the applicable Rules for assignment of class to a new unit are those in force at the date when the contract for construction between the Owner and the shipbuilder is signed (see Note 1).

Note 1:

- a) The date of "contract for construction" of a unit is the date on which the contract to build the unit is signed between the prospective Owner and the shipbuilder. This date and the construction numbers (i.e. hull numbers) of all the units included are to be declared to the Society by the party applying for the assignment of class to a new building.
- b) The date of "contract for construction" of a series of units, including specified optional units for which the option is ultimately exercised, is the date on which the contract to build the series is signed between the prospective Owner and the shipbuilder. For the purpose of this issue, units built under a single contract for construction are considered a "series of units" if they are built to the same approved plans for classification purposes. However, units within a series may have design alterations from the original design provided:
 - 1) such alterations do not affect matters related to classification, or
 - 2) if the alterations are subject to classification requirements, either these alterations comply with the classification requirements in effect on the date on which the alterations are contracted between the prospective Owner and the shipbuilder or, in the absence of the alteration contract, they comply with the classification requirements in effect on the date on which the alterations are submitted to the Society for approval.

The optional units will be considered part of the same series of sister units, if the option is exercised not later than one year after the contract to build the series was signed

- c) If a contract for construction is later amended to include additional units or additional options, the date of "contract for construction" for such units is the date on which the amendment to the contract is signed between the prospective Owner and the shipbuilder. The amendment to the contract is

to be considered as a "new contract" to which a) and b) above apply.

- d) If a contract for construction is amended to change the unit type, the date of "contract for construction" of this modified unit, or units, is the date on which the revised contract or new contract is signed between the Owner, or Owners, and the shipbuilder.

2.2.3 Special consideration may be given to applying new or modified rule requirements which entered into force subsequent to the date of the contract, at the discretion of the Society and in the following cases:

- a) when a justified written request is received from the party applying for classification
- b) when the keel is not yet laid and more than one year has elapsed since the contract was signed
- c) where it is intended to use existing previously approved plans for a new contract.

2.2.4 The rule requirements related to assignment, maintenance and withdrawal of the class of units already in operation are applicable from the date of their entry into force or at the first survey commenced on or after that date.

2.3 Conversion

2.3.1 Conversion of a unit

In case of converted units, the application of the existing items is defined by the Society on a case-by-case basis.

2.3.2 Conversion from an existing ship

When an existing ship is converted into a floating unit, the applicable Rules for assignment of class are those in force at the date when the contract for conversion between the Owner and a contractor is signed.

2.4 Novel features

2.4.1 The Society may consider the classification of units based on or applying novel design principles or features, to which the Rules are not directly applicable, on the basis of experiments, calculations or other supporting information provided to the Society. The specific limitations may then be indicated on the Certificate of Classification.

2.5 Interpretation

2.5.1 The Society alone is qualified to decide upon the meaning, interpretation and application of the Rules and other classification-related documents. No reference to the Rules or other classification-related documents has any value unless it involves, accompanies or follows the intervention of the Society.

2.6 Disagreement and appeal

2.6.1 Any technical disagreement with the Surveyor in connection with the performance of his duties should be raised by the Interested Party as soon as possible.

The Interested Party may appeal in writing to the Society, which will subsequently consider the matter and announce its decision according to its established procedure.

3 Duties of the Interested Parties

3.1 International and national regulations

3.1.1 The classification of a unit does not absolve the Interested Party from compliance with any requirements issued by Administrations of the state whose flag the unit is entitled to fly, and/or of the Coastal State Authority in whose waters the unit operates and any other applicable international and national regulations for the safety of life at sea and protection of the marine environment.

3.1.2 Where requirements of International Conventions, such as SOLAS, ILLC, MARPOL, MODU CODE and ILO or of IMO Assembly Resolutions, are quoted as excerpts, they are printed in italic type replacing the word "Administration" with "Society".

In the event of disputes, the text of the International Conventions will prevail.

3.1.3 When authorised by the Administration concerned, the Society will act on its behalf within the limits of such authorisation. In this respect, the Society will take into account the relevant national requirements, survey the unit, report and issue or contribute to the issue of the corresponding certificates.

When authorized, the Society will also act in respect of National Safety, Coastal State Regulations relating to floating offshore units used for exploitation of hydrocarbons.

The above surveys do not fall within the scope of the classification of units, even though their scope may overlap in part and may be carried out concurrently with surveys for assignment or maintenance of class.

3.1.4 The IACS Unified Interpretations applicable to a unit and its machinery and equipment in accordance with the implementation dates and provisions stated in the Unified Interpretations themselves will be applied, as appropriate, by the Society when acting as a recognised organisation, authorised by a flag State Administration to act on its behalf, unless the flag Administration provides its own interpretation.

3.1.5 In the case of a discrepancy between the provisions of the applicable international and national regulations and those of the Rules, normally, the former take precedence. However, the Society reserves the right to call for the necessary adaptation to preserve the intention of the Rules or to apply the provisions of [1.4.1].

3.2 Surveyor's intervention

3.2.1 Surveyors are to be given free access at all times to units which are classed or being classed, shipyards and

works, to carry out their interventions within the scope of assignment or maintenance of class, or within the scope of interventions carried out on behalf of Administrations, when so delegated.

Free access is also to be given to auditors accompanying the Surveyors of the Society within the scope of the vertical audits as required in pursuance of the Society's internal Quality System or as required by external organizations.

3.2.2 Interested Parties are to take the necessary measures for the Surveyors' inspections and testing to be carried out safely. Interested Parties - irrespective of the nature of the service provided by the Surveyors of the Society or others acting on its behalf - assume with respect to such Surveyors all the responsibility of an employer for his workforce such as to meet the provisions of applicable legislation. As a rule, the Surveyor is to be constantly accompanied during surveys by personnel of the Interested Party.

Refer also to Ch 2, Sec 2, [2.5] to Ch 2, Sec 2, [2.8].

3.2.3 The Certificate of Classification and/or other documents issued by the Society remain the property of the Society. All certificates and documents necessary to the Surveyor's interventions are to be made available by the Interested Party to the Surveyor on request.

3.2.4 During the phases of unit design and construction, due consideration should be given to rule requirements in respect of all necessary arrangements for access to spaces and structures with a view to carrying out class surveys. Arrangements of a special nature are to be brought to the attention of the Society.

3.3 Operation and maintenance of units

3.3.1 Operation of the unit

The classification of a unit is based on the understanding that the unit is loaded and operated in a proper manner by competent and qualified crew or operating personnel according to the loading, environmental, operating and other criteria on which classification is based.

In particular, it will be assumed that the draught of the unit in operating conditions will not exceed that corresponding to the freeboard assigned or the maximum approved for the classification, that the unit will be properly loaded taking into account both its stability and the stresses imposed on its structures and that cargoes will be properly stowed and suitably secured. That the speed and course of the unit are adapted to the prevailing sea and weather conditions according to the normal prudent seamanship and that the unit is operated in accordance with the applicable international and national regulations for the prevention and containment of marine pollution.

3.3.2 Maintenance of the unit

Any document issued by the Society in relation to its interventions reflects the condition of the unit as found at the time and within the scope of the survey. It is the Interested Party's responsibility to ensure proper maintenance of the unit until the next survey required by the Rules. It is the duty of the Interested Party to inform the Surveyor when he boards the unit of any events or circumstances affecting the class.

3.3.3 Hull inspection and maintenance schemes

Hull inspection and maintenance schemes may be adopted by the Owner as a means for maintaining compliance with classification and statutory requirements between surveys. However, these schemes will not be accepted as an alternative to, or a substitute for, the performance of required classification and/or statutory surveys of the hull by the Surveyors of the Society, or of another duly authorised Society (see Note 1). No information received from the Owner indicates that, where adopted, these schemes have proven to be free from any deficiencies

Note 1: The Surveyors may be assisted, where appropriate, by service suppliers as defined in the "Rules for the certification of service suppliers".

3.3.4 Operating Manual (1/7/2023)

An Operating Manual, containing all the information needed to run the unit safely under normal and emergency conditions is to be drafted and kept on board for use of the crew.

It is to include at least the following:

- a) a general description of the unit
- b) pertinent data for each approved mode of operation, including design and variable loading, environmental conditions, assumed sea bed conditions, draft, etc.
- c) a general description of the mooring system
- d) the values of the parameters which define the most severe environmental conditions acceptable during the running and maintenance phases
- e) general plans showing the watertight compartments, openings, air pipes and cargoes allowed in the various zones of the unit
- f) the data for the lightweight unit and the hydrostatic curves (both in upright and heeling conditions) or equivalent data, compiled on the basis of the results of a stability test
- g) capacity plan showing the capacity and centre of gravity and the correction for free surfaces for each tank. If permanent ballast is to be used, the weight, location and substance used are to be clearly indicated
- h) instructions for the running of the unit, including the operations to be carried out to enable it to withstand the most severe environmental working conditions
- i) plans of the ballasting system and instructions for ballast loading and unloading
- j) representative examples of loading conditions for each approved mode of operation, together with means for evaluation of other loading conditions

- k) the data relevant to the stability of the unit, if possible clearly expressing the maximum acceptable value of the height of the centre of gravity in relation to the draught or other parameters in accordance with the unit's stability criteria, in intact condition and, where the assignment of the additional class notation **DMS** is requested, in damaged condition
- l) the mooring and off-loading operations to be carried out for the shuttle
- m) the values of the parameters which establish the maximum assumed environmental conditions to determine the loads acting on the shuttle's mooring system (when applicable)
- n) for units expected to operate on sites characterized by very low ambient temperatures, means to be used or operating limits, if any, as a result of ice accumulation on exposed surfaces
- o) schematic diagram of the electrical installations and the relative electric balance of the main and emergency source of electrical power and of the emergency batteries
- p) the detailed procedures in order to shut down the system installations concerned in the event of an emergency
- q) schematic diagram of the main systems for off-loading and storing the oil fuel
- r) schematic diagram of the inert gas system
- s) schematic diagram of systems to detect toxic and/or flammable mixtures
- t) schematic diagrams of hydrocarbon and/or LNG/LPG handling and processing systems, including venting systems
- u) schematic diagrams of the system for the use of hydrocarbon and/or LNG/LPG as fuel in boilers or internal combustion engines or gas-fired turbines
- v) plans showing the hazardous areas
- w) plans for fire protection, including the type and position of fire detection or fire-extinguishing means and of means of escape from all compartments; as regards this item, see also the provisions in [1.1.3]
- x) the safety provisions, including the position and description of how to use the life-saving appliances and a procedure for abandoning the unit
- y) the conditions related to any seasonal restrictions for the unit's operation
- z) identification and characteristics of the helicopter used as a basis for the design of a possible helicopter deck
 - aa) a detailed description of the operations needed to disconnect and subsequently reconnect the unit to the mooring system, if this is foreseen
 - ab) instructions for the monitoring systems foreseen for the unit
 - ac) the program of periodical surveys and maintenance of the unit
 - ad) identification of the components (if any) made of materials which have uncommon welding

characteristics and the recommended procedures for the relevant repairs

- ae) for propelled floating units permanently moored for long period, a preservation plan of the propulsion and steering systems aimed at preventing damage to the equipment and the watertightness of the compartment
- af) for propelled floating units permanently moored for long period, a re-commissioning procedure of propulsion and steering systems based on the extension of the period of inactivity and agreed with makers of relevant equipment.

The Operating Manual is to contain the particulars relevant to all the elements included which have been subjected to examination and approval by the Society.

3.4 Flag State and Coastal State inspections

3.4.1 Owner's duties

When a unit is detained further to an inspection by the flag Administration or the Coastal State Authority, Owners are to:

- a) immediately report the outcome of this inspection to the Society, and
- b) ask the Society to perform an occasional survey in order to verify that the deficiencies, when related to the class of the unit or to the statutory certificates issued by the Society on behalf of the flag Administration, are rectified and/or the necessary repair work is carried out within the due time.

Should the Owners fail to notify the Society of detention of a unit, the Society reserves the right to suspend or withdraw its classification.

Where non-detectable deficiencies are found by the above-mentioned Authorities, Owners are to inform the Society, which may require the unit to be attended by a Surveyor for the purpose of verifying the correction of the reported deficiencies, if deemed necessary.

3.4.2 Co-operation with and assistance to the inspecting Authority

The Society will co-operate during flag State or Coastal State inspections by liaising with the concerned Authority in accordance with any prior agreement, and the Owner's representative, in order to ensure that both parties are fully aware of actions being taken that affect safety-related matters of either a class or statutory nature.

3.5 Use of measuring equipment and of service suppliers

3.5.1 General

Firms providing services on behalf of the Interested Party, such as measurements, tests and servicing of safety systems and equipment, the results of which may form the basis for the Surveyor's decisions, are subject to the acceptance of the Society, as deemed necessary.

The equipment used during tests and inspections in workshops, shipyards and on board units, the results of which may form the basis for the Surveyor's decisions, is to be customary for the checks to be performed. Firms are to individually identify and calibrate to a recognised national or international standard each piece of such equipment.

3.5.2 Simple measuring equipment

The Surveyor may accept simple measuring equipment (e.g. rulers, tape measures, weld gauges, micrometers) without individual identification or confirmation of calibration, provided it is of standard commercial design, properly maintained and periodically compared with other similar equipment or test pieces.

3.5.3 Shipboard measuring equipment

The Surveyor may accept measuring equipment fitted on board a unit (e.g. pressure, temperature or rpm gauges and meters) and used in examination of shipboard machinery and/or equipment based either on calibration records or comparison of readings with multiple instruments.

3.5.4 Other equipment

The Surveyor may request evidence that other equipment (e.g. tensile test machines, ultrasonic thickness measurement equipment, etc) is calibrated to a recognised national or international standard.

3.6 Spare parts

3.6.1 It is the Owner's responsibility to decide whether and which spare parts are to be carried on board.

3.6.2 As spare parts are outside the scope of classification, the Surveyor will not check that they are kept on board, maintained in a satisfactory condition, or suitably protected and lashed.

However, in the case of repairs or replacement, the spare parts used are to meet the requirements of the Rules as far as practicable; refer to Ch 2, Sec 2, [6.3.2].

SECTION 2

CLASSIFICATION NOTATIONS

1 General

1.1 Purpose of the classification notations

111 The classification notations give the scope according to which the class of the unit has been based and refer to the specific rule requirements which are to be complied with for their assignment. In particular, the classification notations are assigned according to the type, service and operation of the unit and other criteria which have been provided by the Interested Party, when applying for classification.

The Society may change the classification notations at any time, when the information available shows that the requested or already assigned notations are not suitable for the intended service, operation and any other criteria taken into account for classification.

Note 1: Reference should be made to Sec 1, [1.3] on the limits of classification and its meaning.

112 The classification notations assigned to a unit are indicated on the Certificate of Classification, as well as in the Register of Ships published by the Society.

1.2 Types of notations assigned

121 The types of classification notations assigned to a unit are the following:

- a) main class symbol
- b) construction marks
- c) service notations with additional service features, as applicable
- d) operating area notations (optional)
- e) additional class notations (optional)

The different classification notations and their conditions of assignment are listed in [2] to [6] below, according to their types.

1.2.2 (1/7/2011)

As an example, the classification notations assigned to a unit may be as follows (the kind of notation shown in brackets does not form part of the classification notation indicated in the Register of Ships and on the Certificate of Classification):

C ☒

(main class symbol, construction marks)

FPSO-CSR

(service notation and additional service features)

☒**AUT-UMS**

(additional class notation).

1.3 Modes of operation

131 A mode of operation is a condition or manner in which a unit may operate or function while on location or in transit. From the classification aspects the modes of operation of all units are to include the following:

a) Operating condition

A condition when a unit is on location, for the purpose of carrying out its primary design operations and the combined environmental and operational loadings are within the appropriate design limits established for such operations.

b) Survival condition

A severe storm condition during which a unit may be subjected to the most severe environmental loadings for which the unit is designed. Production, drilling or similar operations may have been discontinued due to the severity of the environmental loadings.

c) Transit condition

All units movements from one geographical location to another.

2 Main class symbol

2.1 Main class symbol

211 The main class symbol expresses the degree of compliance of the unit with the rule requirements as regards its construction and maintenance. There is one main class symbol, which is compulsory for every classed unit.

212 The main class symbol **C** is assigned to units built in accordance with the requirements of the Rules or other rules recognised as equivalent, and maintained in a condition considered satisfactory by the Society. The period of class (or interval between class renewal surveys) assigned to a unit is maximum 5 years; see Ch 2, Sec 2, [4].

Except for special cases, class is assigned to a unit only when the hull, propulsion and auxiliary machinery installations, and equipment providing essential services have all been reviewed in relation to the requirements of the Rules.

Note 1: The symbol **C** with the 5 year class period is to be understood as being the highest class granted by the Society.

3 Construction marks

3.1 General

311 The construction mark identifies the procedure under which the unit and its main equipment or arrangements have been surveyed for initial assignment of

the class. The procedures under which the unit is assigned one of the construction marks are detailed in Ch 2, Sec 1.

312 One of the construction marks defined below is assigned separately to the hull of the unit and its appendages, to the machinery installation, and to some installations for which an additional classification notation (see [6] below) is assigned.

The construction mark is placed before the symbol of the service notation and before the additional class notation granted, when such a notation is eligible for a construction mark. When the same construction mark is assigned to both hull and machinery, the construction mark is assigned globally to the unit without indication **HULL** and **MACH** after the main class symbol.

If the unit has no machinery installations covered by classification, the symbol **MACH** is not granted and the construction mark will be placed before the symbol **HULL**.

313 The construction marks refer to the original condition of the unit. However, the Society may change the construction mark where the unit is subjected to repairs, conversion or alterations.

3.2 List of construction marks

321 The mark **⊗** is assigned to the relevant part of the unit, when it has been surveyed by the Society during its construction in compliance with the new building procedure detailed in Ch 2, Sec 1, [2.1].

322 The mark **⊗** is assigned to the relevant part of the unit, when the latter is classed after construction in compliance with the procedure detailed in Ch 2, Sec 1, [3.2] and it was built under the survey of a QSCS Classification Society and was assigned by this Society a class deemed equivalent to that described in the Rules. This mark is also assigned to units admitted to class in the course of construction surveyed by another QSCS Classification Society.

323 The mark **●** is assigned to the relevant part of the unit, where the procedure for the assignment of classification is other than those detailed in [3.2.1] and [3.2.2], but however deemed acceptable.

4 Service notations

4.1 General

411 The service notations define the type and/or service of the unit which have been considered for its classification, according to the request for classification signed by the Interested Party. At least one service notation is to be assigned to every classed unit.

4.1.2 (1/7/2015)

The assignment of any service notation to a new unit is subject to compliance with general Rule requirements laid down in Part B, Part C and Part D and, for some service notations, the additional requirements laid down in Part E

and in the "Common Structural Rules for Bulk Carriers and Oil Tankers".

4.1.3 A unit may be assigned more than one service notation. In such case, the specific rule requirements applicable to each service notation are to be complied with. However, if there is any conflict in the application of the requirements applicable to different service notations, the Society reserves the right to apply the most appropriate requirements or to refuse the assignment of one of the requested service notations.

4.1.4 (1/7/2013)

A service notation may be completed by one or more additional service features, giving further precision regarding the type of service of the unit, for which specific rule requirements are applied.

For each service notation, the different service features which may be assigned are indicated in this item [4]. However, at the request of Interested Parties, an additional service feature may be assigned together with service notations different from those for which the additional service feature is specifically foreseen in this item [4], upon acceptance of the Society, taking into account the service of the unit for which the assignment of the additional service feature is required.

The additional service features are optional and may be assigned as considered appropriate by the Society.

4.1.5 The different service notations which may be assigned to a unit are listed in [4.2] to [4.6], according to the category to which they belong. These service notations are also listed in alphabetical order in Tab 1.

4.1.6 The assignment of a service notation does not absolve the Interested Party from compliance with any international and national regulations established by the Administrations. Neither does it waive the requirements in Sec 1, [3.3.2].

4.2 FSO

421 The service notation **FSO** is assigned to a floating unit intended for the storage and off-loading of liquid hydrocarbons.

4.3 FPSO

431 The service notation **FPSO** is assigned to a floating unit intended for the production, storage and off-loading of liquid hydrocarbons.

4.4 FPU

4.4.1 (1/7/2015)

The service notation **FPU** is assigned to a floating units designed and equipped to receive and process well gaseous hydrocarbons.

4.5 FSRU

451 The service notation **FSRU** is assigned to a floating unit intended for storage, regasification and off-loading of

liquefied natural gas (LNG) and/or liquefied petroleum gas (LPG).

4.6 MODU

461 The service notation **MODU** is assigned to a MODU intended for drilling operations for the exploration or

exploitation of resources beneath the seabed such as liquid or gaseous hydrocarbons, sulphur or salt.

4.7 FLNG

4.7.1 (1/7/2011)

The service notation **FLNG** is assigned to a floating unit intended for liquefaction, storage and off-loading of natural gas.

Table 1 : List of service notations assigned in accordance with the requirements of these Rules (1/7/2015)

Service notation	Reference for definition	Reference chapter in Part E
FSO	[4.2.1]	Part E, Chapter 1
FSO CSR	[4.10.1]	Part E, Chapter 1
FPU	[4.3.1]	Part E, Chapter 6
FPSO	[4.3.1]	Part E, Chapter 2
FPSO CSR	[4.10.1]	Part E, Chapter 2
FSRU	[4.5.1]	Part E, Chapter 3
MODU	[4.6.1]	Part E, Chapter 4
FLNG	[4.7.1]	Part E, Chapter 5
MOSU	[4.8.1]	Part E, Chapter 5
MOSU CSR	[4.10.1]	(1)
SPECIAL SERVICE	[4.9.1]	(2)
<p>(1) Units having the service notation MOSU are to comply with requirements in:</p> <ul style="list-style-type: none"> • Pt A, Pt B, Pt C and Pt D that are applicable to units having the service notation FSO, • Pt E, Ch 1, taking into account the requirements in Sec 1, [2.3.] for conversions. <p>For what concerns the application of fire protection, the requirements in Pt C, Ch 4, Sec 2, [1.1.3] apply.</p> <p>(2) These units are considered on a case by case basis by the Society according to their type of service.</p>		

4.8 MOSU

4.8.1 (1/1/2016)

The service notation **MOSU** is assigned to oil tankers converted in units intended for the storage and off-loading of liquid hydrocarbons and that do not perform any change to their cargo operational and safety characteristics.

MOSU self-propelled units are allowed to perform transfer voyages of very limited extension, between locations in the same area of operation, for loading/unloading operations or safety reasons. The departure and arrival locations are to be communicated by the Owner/Designer to the Society.

MOSU units, to which the navigation notation "**Transfer**" is assigned, in accordance with [5.3], are allowed to voyage, in towing conditions, carrying liquid hydrocarbons cargoes.

MOSU self-propelled units, to which the navigation notation "**Transfer**" is assigned, in accordance with [5.3], are allowed to voyage, using their own propulsion system, in ballast conditions without carrying liquid hydrocarbons cargoes.

4.9 Special service

4.9.1 (1/7/2015)

The service notation special service is assigned to units which, due to the peculiar characteristics of their activity,

are not covered by any of the notations mentioned above. The classification requirements of such units are considered by the Society on a case by case basis.

4.10 Additional service feature CSR

401 Common Structural Rules (CSR) (1/7/2015)

The additional service feature CSR may be assigned to **FSO**, **FPSO** and **MOSU** "Common Structural Rules for Bulk Carriers and Oil Tankers". This notation cannot be assigned retrospectively. It may only be assigned to new build units or units which already had a CSR notation assigned before conversion or redeployment.

4.11 Additional service feature Crane

4.11.1 Crane (1/7/2015)

The additional service feature **Crane** may be assigned to units when a cargo lifting appliance, such as crane or derrick, is permanently fitted on board, the cargo lifting appliance is to be certified by the Society according to the "Rules for loading and unloading arrangements and for other lifting appliances on board of ships", or certified by another QSCS Classification Society according to its equivalent rules.

4.12 Additional service feature Assisted Propulsion

4121 Assisted Propulsion (1/7/2015)

Any unit having a propulsion system not enabling them to proceed at a speed greater than 7 knots, used for short transit voyages, will be assigned the additional service feature assisted propulsion to be added to their own service notation, e.g. **MOSU-Assisted Propulsion**.

4.13 Additional service feature Propulsion Assist

4131 Propulsion Assist (1/7/2015)

Any non-self-propelled unit fitted with thrusters intended to assist in maneuvering or propelling while under tow, will be assigned the additional service feature propulsion assist to be added to their own service notation, e.g. **MOSU-Propulsion Assist**.

5 Navigation, transfer and operating area notations

5.1 Navigation notation

5.1.1 Every classed **MODU** is to be assigned a navigation notation.

5.1.2 The assignment of a navigation notation, including the reduction of scantlings or specific arrangements for restricted navigation notations, is subject to compliance with the requirements laid down in Part B, Part C, Part D and Part E.

5.1.3 The assignment of a navigation notation does not absolve the Interested Party from compliance with any international and national regulations established by the Administrations for units operating in national waters, or a specific area, or a navigation zone. Neither does it waive the requirements in Sec 1,[3.3.1].

5.2 List of navigation notations

5.2.1 The navigation notation **unrestricted navigation** is assigned to a **MODU** intended to operate in any area and any period of the year.

5.2.2 The navigation notation **summer zone** is assigned to a **MODU** intended to operate only within the geographical limits as defined in ILLC 1966 for the Summer zones.

5.2.3 The navigation notation **tropical zone** is assigned to a **MODU** intended to operate only within the geographical limits as defined in ILLC 1966 for the Tropical zones.

5.2.4 The navigation notation **coastal area** is assigned to a **MODU** intended to operate only within 20 nautical miles

from the shore and with a maximum sailing time of six hours from a port of refuge or safe sheltered anchorage.

5.2.5 The navigation notation **sheltered area** is assigned to a **MODU** intended to operate in sheltered waters , i.e. harbours, estuaries, roadsteads, bays, lagoons and generally calm stretches of water and when the wind force does not exceed 6 Beaufort scale.

5.2.6 The navigation notations defined in these items [5.2.1] to [5.2.5] are those considered as "normal". Where particular cases of navigation are to be assigned which are not included among those so defined, the navigation notation **special** is assigned, followed by specified restrictions (such as the designation of the geographical area, distance from the shore and/or the most unfavourable sea conditions considered).

5.2.7 The Society may assign navigation notations provided by the regulations of the flag Administration, which may be different from those defined in [5.2.1] to [5.2.6].

5.3 Transfer notation

5.3.1 (1/1/2016)

The notation transfer is assigned to any type of unit, with the exception of **MODU**, who can voyage using their own propulsion system or in towing conditions, between:

- the construction shipyard and the intended operation site, or
- different intended operation sites, or
- one intended operation site and an ashore berthing,

For the application of the notation **transfer** to **MOSU**, the requirements in [4.8.1] are to be fulfilled.

5.3.2 (1/1/2016)

The notation **transfer**, as defined in [5.3.1], is to be completed as follows:

- **transfer - specific criteria**, when the criteria for the assessment in the transfer phase are based on data and assumptions specified by the Interested Party applying for classification. These criteria are to be stated in the Design Criteria Statement, which is referred to on a memorandum.
- **transfer - navigation notation**: when the transfer navigation is defined by the list given in [5.2] for **MODU**.

Example: **coastal area** or **transfer - within 30 miles form shore**.

5.4 Specified operating area notation

5.4.1 The operating area notation expresses the specified area where some units are designed to operate at sea within specific restrictions which are different from normal navigation conditions.

The operating area notation is always granted to floating units.

5.4.2 The following operating area notations may be assigned:

- a) notation **specified operating site**, where the specific operating location is identified (offshore field name, latitude and longitude)
- b) notation **specified operating area**, where the specific operating conditions which have been considered by the Society are described in the Certificate of Classification (i.e. a certain site in a specific sea, weather or sea conditions)
- c) notation **operation service within 'x' miles from shore**, where the operating service is limited to a certain distance from the shore.

6 Additional class notations

6.1 General

6.1.1 An additional class notation expresses the classification of additional equipment or specific arrangement, which has been requested by the Interested Party.

6.1.2 The assignment of such an additional class notation is subject to the compliance with additional rule requirements, which are detailed in Part F.

6.1.3 Some additional class notations, due to the importance of relevant equipment or arrangements, are assigned a construction mark, according to the principles given in [3.1.2]. This is indicated in the definition of the relevant additional class notations.

6.1.4 The different additional class notations which may be assigned to a unit are listed in [6.2] to [6.10], according to the category to which they belong. These additional class notations are also listed in alphabetical order in Tab 2.

6.1.5 If the Interested Party requests the assignment of additional class notations which are not included in these Rules, but are provided in the Rules for the Classification of Ships, they may be assigned based on the latter Rules, if and as considered appropriate by the Society.

6.2 Automated machinery systems (AUT)

6.2.1 General

The notations dealt with under this heading are relevant to automated machinery systems installed on board units.

In compliance with [6.1.3], these notations are assigned a construction mark, as defined in [3].

The requirements for the assignment of these notations are given in Part F, Chapter 2.

6.2.2 Unattended machinery space (AUT-UMS)

The additional class notation **AUT-UMS** is assigned to units which are fitted with automated installations enabling machinery spaces to remain periodically unattended in all sailing conditions including manoeuvring.

6.2.3 Centralised control station (AUT-CCS)

The additional class notation **AUT-CCS** is assigned to units which are fitted with machinery installations operated and monitored from a centralised control station.

6.3 Monitoring equipment (MON)

6.3.1 General

The notations dealt with under this heading are relevant to hull monitoring equipment installed on board units.

The requirements for the assignment of these notations are given in Part F, Chapter 3.

6.3.2 Hull stress monitoring (MON-HULL)

The additional class notation **MON-HULL** is assigned to units which are fitted with equipment continuously monitoring unit's dynamic loads through measurements of motions in waves and stresses/deformations in the hull structure.

6.4 Comfort on board units (COMF)

6.4.1 General

The additional class notations indicated in Part A, Ch 1, Sec 2 of the Rules for Classification of Ships may be assigned on the basis, as far as applicable, of the requirements given in Part F, Chapter 6 of the Rules for Classification of Ships.

6.5 Pollution prevention

6.5.1 General

The notation dealt with under this heading is assigned to units fitted with equipment and arrangements enabling them to reduce the pollution of the sea and/or air caused by release of solid waste and liquid and/or gaseous effluents.

The requirements for the assignment of these notations are given in Part F, Chapter 3.

6.5.2 Sea and air pollution prevention (GREEN PLUS)

The additional class notation **GREEN PLUS** is assigned to units designed and provided with systems, components and procedural means to control and prevent the emission of polluting substances into the sea and the air, in accordance with the requirements in Pt F, Ch 4, Sec 1.

6.6 Navigation in ice (ICE CLASS)

6.6.1 The additional class notations indicated in Part A, Ch 1, Sec 2 of the Rules for Classification of Ships may be assigned on the basis, as far as applicable, of the requirements given in Part F, Chapter 9 of the Rules for Classification of Ships.

6.7 Navigation in ice (POLAR CLASS)

6.7.1 The additional class notations indicated in Part A, Ch 1, Sec 2 of the Rules for Classification of Ships may be assigned on the basis, as far as applicable, of the requirements given in Part F, Chapter 10 of the Rules for Classification of Ships.

6.8 WINTERIZATION (temp)

6.8.1 The additional class notation **WINTERIZATION (temp)** indicated in Part A, Ch 1, Sec 2 of the Rules for Classification of Ships may be assigned on the basis, as far as applicable, of the requirements given in Part F, Chapter 11 of the Rules for Classification of Ships.

6.9 Planned maintenance scheme and condition based maintenance (PMS/CBM)

6.9.1 General

The notations dealt with under this item [6.9] are assigned to units where a Planned Maintenance Scheme (hereinafter denominated PMS) has been implemented according to the requirements given in Pt F, Ch 6, Sec 5.

6.9.2 PMS

Where a Planned Maintenance Scheme approved by the Society is implemented, the additional class notation **PMS** is assigned.

The requirements for the assignment of this notation are given in Pt F, Ch 1, Sec 1.

6.10 Other additional class notations

6.10.1 In-water survey

The additional class notation **INWATERSURVEY** may be assigned to units provided with suitable arrangements to facilitate the in-water surveys as provided in Ch 2, Sec 2, [5.4.4].

The requirements for the assignment of this notation are given in Pt F, Ch 6, Sec 1.

6.10.2 Dynamic positioning

The additional class notation **DYNAPOS** may be assigned to units equipped with a dynamic positioning system.

In compliance with [6.1.3], this notation is assigned a construction mark, as defined in [3].

The scope of the notation, including the additional keys for the description of capability of the installation and the requirements for assignment, are given in Pt F, Ch 6, Sec 2.

6.10.3 Vapour control system

The additional class notation **VCS** (Vapour Control System) may be assigned to units equipped with cargo vapour control systems both in way of midship cargo crossovers and in way of stern cargo manifolds. The notation -**MIDSHIP** is added to the notation where the unit is equipped with cargo vapour control systems only in way of cargo midship crossovers.

This notation is assigned only to units having the service notation **FPSO** or **FSO**.

The requirements for the assignment of this notation are given in Pt F, Ch 6, Sec 3.

6.10.4 Centralised cargo control

The additional class notation **CARGOCONTROL** may be assigned to units equipped with a centralised system for handling cargo and ballast liquids.

In principle, this notation is assigned only to units having the service notation **FPSO**, **FSO** or **FSRU**.

The requirements for the assignment of this notation are given in Pt F, Ch 6, Sec 4.

6.10.5 Damage stability

The additional class notation **DMS** may be assigned to **FSO**, **FPSO** and **FSRU** complying with the damage stability requirements given in Pt F, Ch 6, Sec 5.

6.10.6 Protective coatings in water ballast tanks

The additional class notation **COAT-WBT** may be assigned to units surveyed during construction by the Society, whose water ballast tanks have been provided with protective coatings complying with the requirements for the assignment of this notation given in Pt F, Ch 6, Sec 6.

The notation may be assigned to units having any service notation.

6.10.7 Fatigue Life (1/1/2026)

The additional class notation **FATIGUELIFE (Y)** is assigned to units designed for a fatigue life greater than Y years. In general, Y is to be not less than 20 years; for units having the additional service feature **CSR**, Y is to be not less than 25 years.

The fatigue life is to be calculated in accordance with the requirements in Pt B, Ch 7, Sec 2; for units having the additional service feature **CSR** the fatigue life is to be calculated in accordance with the requirements in the "Common Structural Rules for Bulk Carriers and Oil Tankers".

When the spectral fatigue analysis is requested, the additional class notation **FATIGUELIFE (Y, Spectral Fatigue Analysis)** is assigned, complying with the requirements in Pt F, Ch 6, Sec 9.

For Y greater than 30 years, the strength calculation and construction criteria are to be defined by the Society on a case-by-case basis.

Where the mooring system has a design fatigue life value different from the one for the structural elements, the notation **FATIGUELIFE (Y)** is complemented by the notation **FATIGUELIFE (Y, Mooring)**, where (Y) is the mooring system's design fatigue life.

Mooring components connected to the hull are covered by the **FATIGUELIFE (Y)** notation, while all the other mooring components are covered by the notation **FATIGUELIFE (Y, Mooring)**.

The fatigue life of mooring system is to be calculated in accordance with the requirements in Pt B, Ch 5, App 3 and Pt B, Ch 9, Sec 3, [2.5].

6.10.8 Residual Fatigue Life (1/7/2023)

The additional class notation **RESIDUALFATIGUELIFE (Y)** is assigned to floating units converted from an existing ship, where Y represents the expected minimum remaining fatigue life, in years, in the site of installation, calculated in accordance with the requirements in Pt B, Ch 7, Sec 2. The notation is followed by the year of maturation of fatigue life and the specific site of installation. For example, **RESIDUALFATIGUELIFE (14), 2023 in Adriatic Sea** indicates that the expected remaining fatigue life is 14

years, which will be matured in the year 2023 for conditions anticipated in the Adriatic Sea.

6.10.9 Permanent means of access

The additional class notation **PMA** is assigned to cargo units that are provided with permanent means of access complying with SOLAS Regulation II-1/3-6, as amended by Resolution MSC 151(78), with the associated "Technical provisions for means of access for inspections" in IMO Resolution MSC 158(78) and the relevant interpretations in IACS UI SC191.

6.10.10 Ballast water management

The additional class notation **BWM-E** is assigned to units complying with the "International Convention for the Control and Management of Ship's Ballast Water and Sediments" as adopted by IMO on 13 February 2004, by means of a Ballast Water Exchange system.

The notation is to be completed by one of the following features, as applicable:

- **sequential** when the Ballast Water Exchange system is of sequential type
- **flow-through** when the Ballast Water Exchange system is of flow-through type
- **dilution** when the Ballast Water Exchange system is of dilution type.

Note 1: according to the above Convention, Ballast Water Exchange will be phased out as an acceptable method, depending on the ballast water capacity and date of delivery of the vessel. After phasing out, the only acceptable method will be Ballast Water Treatment. Therefore the class notation **BWM-E** will be withdrawn when the Ballast Water Exchange is phased out.

The additional class notation **BWM-T** is assigned to units complying with the "International Convention for the Control and Management of Ship's Ballast Water and Sediments" as adopted by IMO on 13 February 2004, by means of a Ballast Water Treatment system.

6.10.11 Crew Accommodation and Recreational Facilities according to the Marine Labour Convention, 2006 (MLCDESIGN)

The additional class notation **MLCDESIGN** is assigned to units having crew accommodation and recreational facilities complying with the requirements of Pt F, Ch 6, Sec 7.

6.10.12 Helideck

The additional class notation **HELIDECK-H** is assigned to units fitted with helicopter facilities in accordance with the requirements of Part F, Chapter 5.

The additional class notation **HELIDECK** is assigned to units where the use of helicopter facilities is only occasional. Units covered by this notation are not provided with hangar, refueling or maintenance facilities, in accordance with requirements of Part F, Chapter 5 with the exception of requirements of Part F, Chapter 5, Section 3 and Section 4, items [1.2] and [2.2].

6.10.13 Drilling system (for MODU's) (1/1/2011)

The additional class notation **DRILLING** is assigned to MODU's which have their drilling systems complying with

the "Rules for the Design and Construction of Drilling Systems".

6.10.14 Technical Advisor Service (TAS) (1/7/2013)

The additional class notation **TAS** is assigned to units whose approved geometry and structural data are stored in a database in order to allow the Society to provide, through dedicated computer programs, the necessary assistance in the event of damage.

6.10.15 Disconnectable (1/1/2016)

The additional class notation **disconnectable** is assigned to units, different from MODU, who can be temporarily disconnected from their fixed location.

6.10.16 Alternative Regime Survey (ARS) (1/1/2023)

The additional class notation **ARS** is assigned to Floating Offshore Units operating at a fixed location, having type B cargo tanks and that comply with the requirements given in Pt F, Ch 6, Sec 8 to allow an extended period between two consecutive internal inspections of each cargo tank.

The **ARS** notation may also be assigned to units having cargo tanks of types other than type B based on the Society's evaluation on a case-by-case basis.

6.10.17 Direct Wave Loading (DWL and DWL (SITE yyy)) (1/1/2026)

The additional class notation **DWL** is assigned to units for which the behaviour of hull structures has been evaluated also for hydrodynamic loads directly applied to a FEM complete model, in addition to the compliance with all the other requirements of the Rules.

The additional notation **DWL** (without specifications) is assigned when the hydrodynamic loads have been determined using the wave environment as if the unit has a 20-year (for units not having the additional service feature CSR) or 25-year (for units having the additional service feature CSR) service life in unrestricted navigation (see sailing ship case in Pt B, Ch 5, App 2, [1] and environmental coefficients in Pt B, Ch 5, Sec 1, [2.7.1]).

If the wave environmental conditions of the intended site are used for the analysis, the additional class notation **DWL (SITE yyy)** is assigned, where yyy is the design return period at the specific site, e.g. **DWL (SITE 100)** if a 100-year return period is used for the specific site.

Wave loads deriving from transit condition to the intended site are also to be considered/evaluated for the assignment of the **DWL (SITE yyy)** notation.

The requirements for the assignment of the additional class notations **DWL** and **DWL (SITE yyy)** are given in Pt F, Ch 6, Sec 10.

7 Other notations

7.1

7.1.1 The Society may also define other notations by means of provisional requirements and guidelines, which may then be published in the form of tentative rules.

Table 2 : List of additional class notations (1/1/2026)

Additional class notation	Reference for definition	Reference in Part F	Remarks
ARS	[6.10.16]	Pt F, Ch 6, Sec 8	
AUT-CCS	[6.2.3]	Part F, Chapter 2	(1)
AUT-UMS	[6.2.2]	Part F, Chapter 2	(1)
BWM-E	[6.10.10]	NA	(3)
BWM-T	[6.10.10]	NA	
CARGOCONTROL	[6.10.4]	Pt F, Ch 6, Sec 4	
COAT-WBT	[6.10.6]	Pt F, Ch 6, Sec 6	
COMF-AIR	See Remarks	See Remarks	Refer to Part F, Ch 6 of the Rules for Classification of Ships
COMF-NOISE	See Remarks	See Remarks	Refer to Part F, Ch 6 of the Rules for Classification of Ships
COMF-VIB	See Remarks	See Remarks	Refer to Part F, Ch 6 of the Rules for Classification of Ships
DISCONNECTABLE	[6.10.15]		
DMS	[6.10.5]	Pt F, Ch 6, Sec 5	
DRILLING	[6.10.13]	NA	Refer to "Rules for the Design and Construction of Drilling Systems"
DWL, DWL (SITE yyy)	[6.10.17]	Pt F, Ch 6, Sec 10	
DYNAPOS	[6.10.2]	Pt F, Ch 6, Sec 2	(1)
FATIGUELIFE (Y)	[6.10.7]	NA	
FATIGUELIFE (Y, Mooring)	[6.10.7]	NA	
FATIGUELIFE (Y, Spectral Fatigue Analysis)	[6.10.7]	Pt F, Ch 6, Sec 9	
GREEN PLUS	[6.5.2]	Part F, Chapter 4	
HELIDECK-H	[6.10.12]	Part F, Chapter 5	
HELIDECK	[6.10.12]	Part F, Chapter 5	
ICE	See Remarks	See Remarks	Refer to Part F, Ch 9 of the Rules for Classification of Ships
ICE CLASS IA	See Remarks	See Remarks	Refer to Part F, Ch 9 of the Rules for Classification of Ships
ICE CLASS IA SUPER	See Remarks	See Remarks	Refer to Part F, Ch 9 of the Rules for Classification of Ships
ICE CLASS IB	See Remarks	See Remarks	Refer to Part F, Ch 9 of the Rules for Classification of Ships
ICE CLASS IC	See Remarks	See Remarks	Refer to Part F, Ch 9 of the Rules for Classification of Ships
ICE CLASS ID	See Remarks	See Remarks	Refer to Part F, Ch 9 of the Rules for Classification of Ships
INWATERSURVEY	[6.10.1]	Pt F, Ch 6, Sec 1	
MLCDESIGN	[6.10.11]	Pt F, Ch 6, Sec 7	
MON-HULL	[6.3.2]	Part F, Chapter 3	
PMA	[6.10.9]	NA	
PMS	[6.9.2]	Part F, Chapter 1	
POLAR CLASS	See Remarks	See Remarks	Refer to Part F, Ch 10 of the Rules for Classification of Ships
RESIDUALFATIGUE (Y)	[6.10.8]	NA	
VCS	[6.10.3]	Pt F, Ch 6, Sec 3	(2)
TAS	[6.10.14]	NA	
WINTERIZATION (temp)	See Remarks	See Remarks	Refer to Part F, Ch 11 of the Rules for Classification of Ships

(1) A construction mark is added to this notation.
(2) This notation may be completed by the specific notations -MIDSHIP and -TRANSFER (see [6.10.3]).
(3) This notation may be completed by the specific features: **sequential**, **flow-through**, **dilution**.

Part A
Classification and Surveys

Chapter 2

**ASSIGNMENT, MAINTENANCE, SUSPENSION AND
WITHDRAWAL OF CLASS**

SECTION 1	ASSIGNMENT OF CLASS
SECTION 2	MAINTENANCE OF CLASS
SECTION 3	SUSPENSION AND WITHDRAWAL OF CLASS
APPENDIX 1	CMS AND PMS: SURVEYS CARRIED OUT BY THE CHIEF ENGINEER
APPENDIX 2	THICKNESS MEASUREMENTS: EXTENT, DETERMINATION OF LOCATIONS AND ACCEPTANCE CRITERIA
APPENDIX 3	CRITERIA FOR LONGITUDINAL STRENGTH OF THE HULL GIRDER

SECTION 1

ASSIGNMENT OF CLASS

1 General

1.1 Main cases of assignment of class

1.1.1 Assignment of class (1/2/2021)

Class is assigned to a unit upon a survey, with the associated operations, which is held in order to verify whether it is eligible to be classed on the basis of the Rules of the Society (see Ch 1, Sec 1, [1.3.2]). This may be achieved through:

- a) the completion of the new building, during which a survey has been performed,
- b) the completion of the new building, during which the survey has been carried out according to IACS Procedural Requirement PR 1B when the Society's class is assigned under double class or dual class regime with another QSCS Classification Society, or
- c) a survey carried out according to the IACS Procedural Requirement PR 1A when units change class from one QSCS Classification Society see Note 1 to the Society, or
- d) a survey carried out according to the IACS Procedural Requirement PR 1B, when the Society's class is added to a unit already in class with another QSCS Classification Society, or
- e) a survey carried out according to the IACS Procedural Requirement PR1D, when units change class from one non-QSCS Classification Society (see Note 1) to the Society or is not classed at all
- f) a specific admission to class survey, in cases where a unit is classed with a non-QSCS Classification Society or is not classed at all.

Note 1: The obligations of the Procedural Requirement PR1A, PR1B and PR1D apply as pertinent to QSCS Classification Societies.

1.1.2 Reassignment of class (1/7/2015)

Reassignment of class is that part of the process of classification consisting in all the steps aimed at issuing a Certificate of Classification to a unit previously classed with the Society but which had the class withdrawn.

Four cases are considered for reassignment of class:

- a) unit in service classed by another QSCS Classification Society,
- b) unit in service not classed by another QSCS Classification Society,
- c) unit no longer in service since the withdrawal of the class by the Society,
- d) unit no longer in service since the withdrawal of the class by another Society, QSCS or not.

2 New building procedure

2.1 Units surveyed by the Society during construction

2.1.1 When a unit is surveyed by the Society during construction, it is to comply with those requirements of the Rules which are in force and applicable depending on the class of the unit, taking into account the provisions of Ch 1, Sec 1, [2.2].

2.1.2 The Society:

- a) approves the plans and documentation submitted as required by the Rules
- b) proceeds, if required, with the appraisal of the design of materials and equipment used in the construction of the unit and their inspection at works
- c) carries out surveys or obtains appropriate evidence to satisfy itself that the scantlings and construction meet the rule requirements in relation to the approved drawings
- d) attends tests and trials provided for in the Rules
- e) assigns the construction mark ⌘; refer to Ch 1, Sec 2, [3.2.1].

2.1.3 The Society defines in specific Rules which materials and equipment used for the construction of units built under survey are, as a rule, subject to appraisal of their design and to inspection at works, and according to which particulars.

2.1.4 As part of his interventions during the unit's construction, the Surveyor will:

- a) conduct an overall examination of the parts of the unit covered by the Rules
- b) examine the construction methods and procedures when required by the Rules
- c) check selected items covered by the rule requirements
- d) attend tests and trials where applicable and deemed necessary.

2.1.5 Use of materials, machinery, appliances and items

As a general rule, all materials, machinery, boilers, auxiliary installations, equipment, items etc. (generally referred to as "products") which are covered by the class and used or fitted on board units surveyed by the Society during construction are to be new and, where intended for essential services as defined in, tested by the Society.

Second hand materials, machinery, appliances and items may be used subject to the specific agreement of the Society and the Owner.

The requirements for the selection of materials to be used in the construction of the various parts of a unit, the characteristics of products to be used for such parts and the checks required for their acceptance are to be as stated in Part C and Part D, as applicable, or in other Parts of the Rules or as specified on approved plans. In particular, the testing of products manufactured according to quality assurance procedures approved by the Society and the approval of such procedures are governed by the requirements of Pt D, Ch 1, Sec 1, [3] of the Rules for the Classification of Ships.

2.1.6 Defects or deficiencies and their repair

The Society may, at any time, reject items found to be defective or contrary to rule requirements or require supplementary inspections and tests and/or modifications, notwithstanding any previous certificates issued.

All repairs are subject to the preliminary agreement of the Society. When the limits of tolerance for defects are specified in the Rules concerned or by the Manufacturer, they are to be taken into account for repairs.

It is incumbent upon the Interested Party to notify the Society of any defects noted during the construction of the unit and/or of any item not complying with the applicable requirements or in any case unsatisfactory. Proposals regarding remedial actions intended to be adopted to eliminate such defects or unsatisfactory items are to be submitted to the Society and, if accepted, carried out to the Surveyor's satisfaction.

2.1.7 Equivalence of Rule testing under certain conditions

Notwithstanding the provisions of [2.1.5], the Society may, at its discretion and subject to conditions and checks deemed appropriate, accept certain materials, appliances or machinery which have not been subjected to rule testing.

2.1.8 Equivalence of design approval by another QSCS Classification Society under certain conditions

The Society may, at its discretion and subject to conditions and checks deemed appropriate, accept the plans and documentation approved by another QSCS Classification Society, as far as classification is concerned and according to the principle of equivalence of Rules in Ch 1, Sec 1, [2.1].

2.1.9 Interim Certificate of Classification

Upon satisfactory completion of the survey during construction, the Surveyor issues to the shipyard an interim Certificate of Classification valid not more than 5 months. This certificate indicates the class notations.

The certificate is issued with a letter where all outstanding recommendations and significant memoranda are recorded; class notations requested by the shipyard and not assigned due to pending items are clearly indicated together with the relevant pending items.

It is the shipyard's duty to provide the Owner with the interim Certificate of Classification and a copy of the letter.

2.1.10 Certificate of Classification

Upon satisfactory review of the survey reports, the Society issues to the shipyard the Certificate of Classification valid for the whole period of class. The certificate indicates the class notations.

The Certificate of Classification may be provided directly to the Owner upon request, subject to written authorisation from the shipyard.

All outstanding recommendations, significant memoranda and pending items for class notations not assigned are made available in the survey status.

2.2 Other cases

2.2.1 When the procedure adopted does not comply with that detailed in [2.1] but the Society deems that it is acceptable for the assignment of class, the construction mark ● is assigned in accordance with Ch 1, Sec 2, [3.2.3].

2.3 Documentation

2.3.1 Documentation relevant to the class applied for is to be submitted for the approval of the Society.

2.3.2 The design data, calculations and plans to be submitted are listed in the relevant chapters of the Rules.

The Society may also call for additional information according to the specific nature of the unit to be classed.

The documentation requested in the various Chapters of the Rules in hard copy may, as an alternative, be submitted in electronic format to be agreed with the Society.

2.3.3 The documentation submitted to the Society is examined in relation to the class applied for in the request for classification.

Note 1: Should the Interested Party subsequently wish to have the class, in particular the service notation or navigation / operating area notation, granted to the unit modified, plans and drawings are generally to be re-examined.

2.3.4 A copy of the submitted plans will be returned duly stamped, with remarks related to the compliance with the rule requirements should the need arise.

2.3.5 As a rule, modifications of the approved plans regarding items covered by classification are to be submitted.

2.3.6 Design data to be submitted to the Society are to incorporate all information necessary for the assessment of the design of the unit for the purpose of assignment of class. It is the responsibility of the Interested Party to ascertain that the design data are correct, complete and compatible with the use of the unit.

2.3.7 Design calculations are to be provided, when called for, as supporting documents to the submitted plans.

2.3.8 Design data and calculations are to be adequately referenced. It is the duty of the Interested Party to ascertain that the references used are correct, complete and applicable to the design of the unit.

2.3.9 The submitted plans are to contain all necessary information for checking the compliance with the requirements of the Rules.

2.3.10 In the case of conflicting information, submitted documentation will be considered in the following order of precedence: design data, plans, design calculations.

2.3.11 It is the responsibility of the Interested Party to ascertain that drawings used for the procurement, construction and other works are in accordance with the approved plans.

2.4 Assignment of Double Class to a unit surveyed during construction by two Societies

2.4.1 Double Class (1/2/2021)

A double class unit is one which is classed by two Societies, where each Society acts independently during construction.

2.4.2 General (1/2/2021)

The requirements from [2.1] to [2.3] apply also for the assignment of the Double Class to a new construction

2.4.3 Survey (1/2/2021)

The surveyor surveys the unit to check that it complies with the requirements of Ch 3, Sec 1, [3.1].

2.5 Assignment of a Dual Class to a unit surveyed during construction by two QSCS Classification Societies and in full compliance with all applicable and relevant IACS Resolutions (IACS PR 1B)

2.5.1 Dual Class (1/2/2021)

A dual class new building is one which is classed during construction by two Societies where each Society acts on behalf of the other Society in accordance with the trilateral agreement adopted by the two Societies and the shipyard. This agreement shall clearly define modalities such as submission of plans, rules to be applied, harmonizing and resolution of plan approval comments between societies.

2.5.2 Basic conditions (1/2/2021)

The Procedural Requirements for assigning dual class are applicable when none of the Societies which carried out the new construction technical review has issued its first Certificate of Classification (see Note 1). Unless stated otherwise, the provisions apply to units of over 100 GT of whatever type, self-propelled or not, restricted or unrestricted service, except for "inland waterway" units. Cases concerning units of 100 GT or less are dealt with by the Society on a case-by case basis.

Whenever the Societies are requested by a Shipyard/Owner to accept a new building into their class under dual class:

- a) each Society is to share information and records related to new construction such as plan approval including following up and closing of comments imposed, surveys, inspection, witnesses and tests etc., to perform the sur-

veys and verify compliance with the relevant requirements; and

- b) each Society is to issue a certificate of classification for the vessel upon satisfactory completion of new construction survey process.

Note 1: "First Certificate of Classification" means either the Interim Certificate of Classification or full term Certificate of Classification or another document serving the same purpose.

2.5.3 General (1/2/2021)

The requirements from [2.1] to [2.3] are applied in accordance with the trilateral agreement referred to in [2.5.1].

2.5.4 Surveys (1/2/2021)

The surveyor surveys the unit to check that it complies with the requirements of Ch 3, Sec 1, [3.2].

3 Units classed after construction

3.1 General

3.1.1 (1/7/2015)

When an Owner applies to the Society for a unit already in service to be admitted to class, the application will be processed differently depending on whether the unit is:

- a) classed with a QSCS Classification Society, or
- b) not classed with a QSCS Classification Society, or
- c) not classed at all.

3.2 Transfer to the Society's class of a unit in service classed by another QSCS Classification Society (IACS PR 1A)

3.2.1 Documentation to be submitted and design assessment (1/1/2014)

As a rule, the minimum documentation to be supplied for filing purposes is listed hereinafter, as far as applicable with regard to the unit concerned. The Society may carry out a design assessment on a case-by-case basis (additional documentation may be requested).

- a) Main plans:
 - 1) general arrangement,
 - 2) capacity plan,
 - 3) hydrostatic curves,
 - 4) loading manual where required,
 - 5) damage stability calculation, where required.
- b) Hull structure plans:
 - 1) midship section,
 - 2) scantling plan,
 - 3) decks,
 - 4) shell expansion,
 - 5) transverse bulkheads,
 - 6) rudder and rudder stock,
 - 7) hatch covers.

- c) Machinery plans:
 - 1) machinery arrangement,
 - 2) intermediate, thrust and screw shafts,
 - 3) propeller,
 - 4) main engines, propulsion gears and clutch systems (or Manufacturer's make, model and rating information),
 - 5) for units with steam turbine sets: auxiliary boilers, superheaters and economisers (or Manufacturer's make, model and rating information) and steam piping,
 - 6) bilge and ballast piping diagram,
 - 7) wiring diagram,
 - 8) steering gear system piping and arrangements and steering gear (or Manufacturer's make and model information),
 - 9) torsion vibration calculations for units less than two years old,
 - 10) plans for flexible couplings and/or torque limiting shafting devices in the propulsion line shafting (or Manufacturer's make, model and rating information), for units assigned with one of the ice additional class notations described in Ch 1, Sec 2, [6.10.2],
 - 11) pumping arrangements at the forward and after ends, drainage of cofferdams and pump rooms for FSO or FPSO units.
- d) operating manual
- e) Plans required for units assigned one of the additional class notations for Automated Machinery Systems:
 - 1) instrument and alarm list,
 - 2) fire alarm system,
 - 3) list of automatic safety functions (e.g. slowdowns, shutdowns, etc),
 - 4) function testing plan.

Alternative technical data may be accepted by the Society in lieu of specific items of the listed documentation not available at the time of the transfer of class.

3.2.2 Basic conditions of IACS Procedural Requirement PR 1A

This Procedural Requirement is applicable, unless stated otherwise, to units of over 100 GT of whatever type, self-propelled or not, restricted or unrestricted navigation.

The age of the unit considered in the procedure for transfer of class is the age calculated from the date of delivery to the "Date Request for class was received" in Form G Part A - Survey Status Request.

The obligations of the Procedural Requirement continue to apply when a unit's class is suspended by the losing Society and for 6 months following withdrawal of a unit's class by the losing Society.

Whenever the Society is requested by an Owner to accept a unit in service into class:

- a) the relevant surveys specified in Ch 3, Sec 2 are to be satisfactorily completed for entry into class;
- b) for units less than 15 years of age, an Interim Certificate of Classification can be issued only after the Society has completed all overdue surveys and all overdue recommendations previously issued against the unit as specified to the Owner by the losing Society;
- c) for units 15 years of age and over, an Interim Certificate of Classification can be issued only after the losing Society has completed all overdue surveys and all overdue recommendations previously issued against the unit;
- d) any outstanding recommendations are to be dealt with by their due dates;
- e) the principles given in a), b) and c) above apply to any additional recommendations issued against the unit arising from surveys which were not included in the initial survey status provided to the Society by the losing Society because the surveys were carried out in close proximity to the request for transfer of class. If received after the issuance of the Interim Certificate of Classification by the Society and overdue, such additional recommendations are to be dealt with at the first port of call by the relevant Society depending on the age of the unit;
- f) copies of the plans listed in [3.2.1] are to be provided to the Society as a prerequisite to obtaining a full term Certificate of Classification. If the Owner is unable to provide all of the required plans, the losing Society is to be authorised by the Owner to transfer copies of such of these plans as it may possess directly to and upon request from the Society.

3.2.3 Conditions of IACS Procedural Requirement PR 1A, preventing issue of the Interim Certificate of Classification (1/1/2014)

Prior to issuing an Interim Certificate of Classification, the Society is to obtain:

- a) from the Owner, a written request for transfer of class, containing an authorisation for the Society to obtain the current classification status from the losing Society; and
- b) the current classification survey status from the Headquarters of the losing Society or one of its designated control or management centres.

If the Society does not receive the classification survey status from the losing Society within 3 working days from the request, the Society may utilise the losing Society's survey status information provided by the Owner and, after complying with the other relevant provisions of the Procedural Requirement, issue an Interim Certificate of Classification. In such cases the conditions in [3.2.2] are still applicable (a statement is normally included in the Interim Certificate of Classification for this purpose).

The Society cannot issue an Interim Certificate of Classification, or other documents enabling the unit to trade:

- 1) until all overdue surveys and all overdue recommendations previously issued against the subject unit, as specified to the Owner by the losing Society, have been completed and rectified either by the Society for units

less than 15 years of age or by the losing Society for units 15 years of age and above;;

- 2) until all relevant surveys specified in Ch 3, Sec 2, [1.1.2] have been satisfactorily completed; when facilities are not available in the first port of survey, an Interim Certificate of Classification may be issued to allow the unit to undertake a direct voyage to a port where facilities are available to complete surveys required in Ch 3, Sec 2, [1.1.2]. In such cases the surveys specified in Ch 3, Sec 2, [1.1.2] are to be carried out to the maximum extent practicable at the first port of survey, but in no case less than the scope of annual hull surveys and machinery surveys as required in Ch 3, Sec 2, [1.1.2] b);
- 3) before giving the opportunity to the flag Administration to provide any further instructions within 3 working days, in compliance with the requirements of Art. 10.5 of the Regulation (EC) No 391/2009.

3.2.4 Limitations of IACS Procedural Requirement PR 1A for the Certificate of Classification

The validity of the Interim Certificate of Classification and the subsequent Certificate of Classification is subject to any outstanding recommendations previously issued against the unit being completed by the due date and as specified by the losing Society. Any outstanding recommendations with their due dates are stated on the Survey Endorsement Sheets and survey status when the full term Certificate of Classification is issued.

If additional information regarding overdue surveys or recommendations is received from the losing Society after the Interim Certificate of Classification has been issued, these are to be dealt with at the first port of call by the Society for units less than 15 years of age or by the losing Society for units 15 years of age or over. If this is not accomplished, the Interim Certificate of Classification is withdrawn immediately unless the Owner agrees to proceed directly, without further trading, to a suitable port where any overdue surveys or overdue recommendations are to be carried out by the relevant Society based on the age of the unit.

3.2.5 Surveys

The Surveyor:

- a) checks that the outcome of the design assessment (if any), survey instructions and losing Society's survey status are available,
- b) surveys the unit to check that it complies with the outcome of the design assessment (if any) and with the requirements Ch 3, Sec 2, [1.1.2].

3.2.6 Interim Certificate of Classification

Upon satisfactory completion of the survey for assignment of class, the Surveyor issues to the Owner an interim Certificate of Classification valid not more than 5 months, provided that the conditions in [3.2.2] to [3.2.5] are met. This certificate indicates the class notations.

The certificate is issued with a Survey Endorsement Sheet where all outstanding recommendations and significant memoranda are recorded; class notations requested by the Owner and not assigned due to pending items are clearly indicated together with the relevant pending items.

3.2.7 Certificate of Classification

Upon satisfactory review of the survey reports, the Society issues to the Owner the Certificate of Classification valid for the whole period of class, provided that the conditions in [3.2.2] to [3.2.5] are met. The certificate indicates the class notations.

All outstanding recommendations, significant memoranda and pending items for class notations not assigned are made available in the survey status.

3.3 Transfer to the Society's class of a unit surveyed during construction by another IACS Society at unit's delivery (IACS PR 1A)

3.3.1 Documentation to be submitted and design assessment

The requirements of [3.2.1] apply.

3.3.2 Basic conditions of IACS Procedural Requirement PR 1A

The Procedural Requirements for transfer of class at unit's delivery (see Note 1) are applicable when the Society which carried out the new construction technical review and surveys (i.e. the losing Society) has issued its first Certificate of Classification (see Note 2). Unless stated otherwise, the provisions apply to units of over 100 GT of whatever type, self-propelled or not, restricted or unrestricted service.

Whenever the Society is requested by an Owner to accept a unit into class at its delivery, the Society immediately notifies the Owner in writing that:

- a) any outstanding recommendations are to be dealt with by their due dates;
- b) copies of the plans listed in [3.2.1] are to be provided to the Society as a prerequisite to obtaining a full term Certificate of Classification.

If the Owner is unable to provide all of the required plans, the Society requests that the Owner authorises the losing Society to transfer copies of such of these plans as it may possess directly to and upon request from the Society, with the advice that the losing Society will invoice the Society and the Society may, in turn, charge the associated costs to the Owner.

Note 1: "At unit's delivery" means that the new construction survey process is completed and the unit has not departed from the yard.

Note 2: "First Certificate of Classification" means either the Interim Certificate of Classification or full term Certificate of Classification or another document serving the same purpose.

3.3.3 Conditions of IACS Procedural Requirement PR 1A, preventing issue of the Interim Certificate of Classification (1/1/2014)

Prior to issuing an Interim Certificate of Classification on the date of the unit's delivery, the Society is to obtain:

- a) from the Owner, a written request for transfer of class at unit's delivery, containing an authorisation for the Society to obtain a copy of the first Certificate of Classification from the losing Society; and
- b) the first Certificate of Classification from the Headquarters of the losing Society or one of its designated control

or management centres or from the attending Surveyor at the builder's yard, including any outstanding recommendations and information normally contained in the classification status.

If the Society does not receive the above documents from the losing Society on the date of the unit's delivery, the Society may utilise the losing Society's said documents provided by the Owner and, after complying with the other relevant provisions of this Procedural Requirement, issue an Interim Certificate of Classification on the date of the unit's delivery. In such cases, the conditions in [3.3.2] are still applicable (a statement is normally included in the Interim Certificate of Classification for this purpose).

The Society cannot issue an Interim Certificate of Classification, or other documents enabling the unit to trade:

- 1) until all relevant surveys specified in Ch 3, Sec 2, [1.3.1] have been satisfactorily completed; and
- 2) before giving the opportunity to the flag Administration to provide any further instructions within 3 working days, in compliance with the requirements of Art. 10.5 of the Regulation (EC) No 391/2009.

3.3.4 Limitations of IACS Procedural Requirement PR 1A for the Certificate of Classification

The validity of the Interim Certificate of Classification and the subsequent full term Certificate of Classification issued by the Society is subject to any outstanding recommendations previously issued against the unit being completed by the due dates and as specified by the losing Society. Any outstanding recommendations with their due dates and information normally contained in the classification status are to be clearly stated on the:

- a) first Certificate of Classification or an attachment to the first Certificate of Classification and/or the Survey Endorsement Sheet available onboard
- b) survey status when the full term Certificate of Classification is issued.

3.3.5 Surveys

The Surveyor:

- a) checks that the outcome of the design assessment (if any), survey instructions and the first Certificate of Classification or an attachment to the first Certificate of Classification and/or a class survey record from the losing Society are available,
- b) surveys the unit to check that it complies with the outcome of the design assessment (if any) and with the requirements of Ch 3, Sec 2, [1.2.1].

3.3.6 Interim Certificate of Classification

Upon satisfactory completion of the survey for assignment of class, the Surveyor issues to the Owner an Interim Certificate of Classification valid not more than 5 months, provided that the conditions in [3.3.2] to [3.3.5] are met. This certificate indicates the class notations.

The certificate is issued with a Survey Endorsement Sheet where all outstanding recommendations and significant memoranda are recorded; class notations requested by the

Owner and not assigned due to pending items are clearly indicated together with the relevant pending items.

3.3.7 Certificate of Classification

Upon satisfactory review of the survey reports, the Society issues to the Owner the Certificate of Classification valid for the whole period of class, provided that the conditions in [3.3.2] to [3.3.5] are met. The certificate indicates the class notations.

All outstanding recommendations, significant memoranda and pending items for class notations not assigned are made available in the survey status.

3.4 Addition of the Society's class to a unit in service classed by another a QSCS Classification Society (IACS PR1B)

3.4.1 Documentation to be submitted and design assessment

The requirements of [3.2.1] apply.

3.4.2 Basic conditions of IACS Procedural Requirement PR 1A

This Procedural Requirement is applicable, unless stated otherwise, to units of over 100 GT of whatever type, self-propelled or not, restricted or unrestricted service.

The obligations of the Procedural Requirement continue to apply when a unit's class is suspended by the losing Society and for 6 months following withdrawal of a unit's class by the losing Society.

Whenever the Society is requested by an Owner to accept a unit in service already classed by another a QSCS Classification Society into its class under double or dual class arrangement, the following applies.

- a) the Society only accepts a unit that is free from any overdue surveys or recommendations;
- b) the Owner is to inform the first Society of his request to the Society;
- c) the Owner is to authorise the first Society to submit to the Society its current classification status and documents as listed in Annex 3 of IACS PR 1 Annex - "Content of Vessel's History Report Regarding Class Items" for information and use by the Society in conducting its assignment of class surveys;
- d) when the Owner decides to leave the double or dual class arrangement and prior to withdrawing from the class of either of the Societies, he is to inform the Societies of his intended actions;
- e) when the Owner is advised that one of the Societies involved in double or dual class arrangement is suspending or withdrawing class, he is to inform the remaining Society of the action taken by the other Society without delay;
- f) copies of the plans listed in [3.2.1] are to be provided to the Society as a prerequisite to obtaining a full term Certificate of Classification. If the Owner is unable to provide all of the required plans, the first Society is to be authorised by the Owner to transfer copies of such of these plans as it may possess directly to and upon request from the Society.

3.4.3 Conditions of IACS Procedural Requirement PR 1A, preventing issue of the Interim Certificate of Classification

Prior to issuing an Interim Certificate of Classification the Society is to:

- a) obtain from the Owner, a written application for entry into the Society's class, containing an authorisation for the Society to obtain the current classification status from the first Society;
- b) obtain the first Certificate of Classification from the Headquarters of the first Society or from one of its designated control or management centres or from the attending Surveyor at the yard of the builders, including any outstanding recommendations/conditions of class and information normally contained in the classification status; and
- c) carry out and satisfactorily complete all relevant surveys specified in Ch 3, Sec 2, [1.2.1].

3.4.4 Limitations of IACS Procedural Requirement PR 1A for the Certificate of Classification

The validity of the Interim Certificate of Classification and the subsequent Certificate of Classification is subject to any outstanding recommendations previously issued against the unit being completed by the due dates and as specified by the first Society. Any outstanding recommendations with their due dates are stated on the Survey Endorsement Sheets and survey status when the full term Certificate of Classification is issued.

3.4.5 Surveys

The Surveyor:

- a) checks that the outcome of the design assessment (if any), survey instructions and first Society's survey status are available;
- b) surveys the unit to check that it complies with the outcome of the design assessment (if any) and with the requirements of Ch 3, Sec 2, [1.1.2].

3.4.6 Interim Certificate of Classification

Upon satisfactory completion of the survey for assignment of class, the Surveyor issues to the Owner an Interim Certificate of Classification valid not more than 5 months, provided that the conditions in [3.4.2] to [3.4.5] are met. This certificate indicates the class notations.

The certificate is issued with a Survey Endorsement Sheet where all outstanding recommendations and significant memoranda are recorded; class notations requested by the Owner and not assigned due to pending items are clearly indicated together with the relevant pending items.

3.4.7 Certificate of Classification

Upon satisfactory review of the survey reports, the Society issues to the Owner the Certificate of Classification valid for the whole period of class, provided that the conditions in [3.4.2] to [3.4.5] are met. The Certificate indicates the class notations.

All outstanding recommendations, significant memoranda and pending items for class notations not assigned are made available in the survey status.

3.5 Addition of the Society's class to a unit surveyed during construction by another QSCS Classification Society at the unit's delivery (IACS PR1B)

3.5.1 Documentation to be submitted and design assessment

The requirements of [3.2.1] apply.

3.5.2 Basic conditions of IACS Procedural Requirement PR 1A

The Procedural Requirements for adding class at unit's delivery are applicable when the Society which carried out the new construction technical review and surveys (i.e. the first Society) has issued its first Certificate of (see Note 2 to item [3.3.2]). Unless stated otherwise, the provisions apply to units of over 100 GT of whatever type, self-propelled or not, restricted or unrestricted service.

Whenever the Society is requested by an Owner to accept a unit already classed by another QSCS Classification Society (the first Society) into its class under double or dual class arrangement at unit's delivery, the following applies:

- a) the Owner is to inform the first Society of his request to the Society;
- b) the Owner is to authorise the first Society to submit to the Society its Certificate of Classification;
- c) when the Owner decides to leave the double or dual class arrangement and prior to withdrawing from the class of either of the Societies, he is to inform the Societies of his intended actions;
- d) when the Owner is advised that one of the Societies involved in double or dual class arrangement is suspending or withdrawing class, he is to inform the remaining Society of the action taken by the other Society without delay;
- e) copies of the plans listed in [3.2.1] are to be provided to the Society as a prerequisite to obtaining a full term Certificate of Classification. If the Owner is unable to provide all of the required plans, the Society requests that the Owner authorise the first Society to transfer copies of such of these plans as it may possess directly to and upon request from the Society, with the advice that the first Society will invoice the Society and the Society may, in turn, charge the associated costs to the Owner.

3.5.3 Conditions of IACS Procedural Requirement PR 1A, preventing issue of the Interim Certificate of Classification

Prior to issuing an Interim Certificate of Classification on the date of the unit's delivery, the Society is to obtain:

- a) from the Owner, a written request for entry into the Society's class at unit's delivery, containing an authorisation for the Society to obtain a copy of the first Certificate of Classification from the first Society; and
- b) the first Certificate of Classification from the Headquarters of the first Society or one of its designated control or management centres or from the attending Surveyor at the builder's yard, including any outstanding recommendations and information normally contained in the classification status.

3.5.4 Limitations of IACS Procedural Requirement PR 1A for the Certificate of Classification

Prior to final entry into its class, the Society is obligated to obtain plans and information in accordance with the requirements of [3.2.1].

3.5.5 Surveys

The Surveyor:

- a) checks that the outcome of the design assessment (if any), survey instructions and the first Certificate of Classification or an attachment to the first Certificate of Classification and/or a class survey record from the first Society are available,
- b) surveys the unit to check that it complies with the outcome of the design assessment (if any) and with the requirements of Ch 3, Sec 2, [1.4.1].

3.5.6 Interim Certificate of Classification

Upon satisfactory completion of the survey for assignment of class, the Surveyor issues to the Owner an interim Certificate of Classification valid not more than 5 months, provided that the conditions in [3.5.2] to [3.5.5] are met. This certificate indicates the class notations.

The certificate is issued with a Survey Endorsement Sheet where all outstanding recommendations and significant memoranda are recorded; class notations requested by the Owner and not assigned due to pending items are clearly indicated together with the relevant pending items.

3.5.7 Certificate of Classification

Upon satisfactory review of the survey reports, the Society issues to the Owner the Certificate of Classification valid for the whole period of class, provided that the conditions in [3.5.2] to [3.5.5] are met. The certificate indicates the class notations.

All outstanding recommendations, significant memoranda and pending items for class notations not assigned are made available in the survey status.

3.6 Units in service not classed with a QSCS Society or not classed at all (PR1D)

3.6.1 General (1/7/2015)

In the case of a unit not classed with a QSCS Classification Society, or not classed at all, the requirements of [3.6.2] to [3.6.10] apply.

3.6.2 Documentation to be submitted and design assessment (1/7/2015)

As a rule, the minimum documentation to be supplied is listed hereinafter, as far as applicable with regard to the unit concerned. The Society will carry out a plan appraisal before the Interim Certificate of Classification is issued.

Main plans:

- a) Main plans:
 - 1) general arrangement,
 - 2) capacity plan,
 - 3) loading manual, where required, which is to contain, as a minimum, loading cases, calculations of

still water bending moments, and relevant documents, particulars of loading calculator and instruction booklet as per the Society's requirements, according to the case,

- 4) hydrostatic curves and stability documentation, as applicable (refer to Part B, Chapter 3),
 - 5) damage stability calculations, where required,
 - 6) stability documentation, as applicable (refer to Part B, Chapter 3).
- b) Hull structure plans:
 - 1) midship section,
 - 2) scantling plans,
 - 3) profile and deck plan,
 - 4) shell expansion,
 - 5) watertight bulkheads, transverse and longitudinal (if any),
 - 6) rudder and rudder stock,
 - 7) hatch cover,
 - 8) for CSR units, plans showing, for each structural element, both as-built and renewal thicknesses and any thickness for "voluntary addition".
 - c) Machinery plans:
 - 1) engine room general arrangement,
 - 2) diagram of fuel (transfer, service), bilge, ballast, lubricating oil, cooling, steam and feed, general service and starting compressed air piping,
 - 3) intermediate, thrust- and screwshafts,
 - 4) propeller,
 - 5) main engines, propulsion gears and clutch systems (or Manufacturer make, model and rating information)
 - 6) for steam turbine, vessels, main boilers, superheaters and economisers (or Manufacturer make, model and rating information) and steam piping,
 - 7) drawings of boilers and air receivers,
 - 8) drawings of steering gear systems, piping and arrangements and steering gear Manufacturer make and model information,
 - 9) torsional vibration calculations as per conditions laid down in Pt C, Ch 1, Sec 10 of the Rules for the Classification of Ships; such documents are required only for units less than 2 years old or for older units the propelling system of which has been modified during the two years preceding the classification.
 - d) Operating manual
 - e) Electrical installation plans and wiring diagrams:
 - 1) master plan of power distribution, lighting and emergency power circuits,
 - 2) single line diagram of networks and switchboards,
 - 3) location and arrangement of electrical equipment in hazardous areas.

- f) Additional requirements for units with ice class notation:
- 1) plans for flexible couplings and/or torque limiting shafting devices in the propulsion line shafting (or manufacturer make, model and rating information).
- g) Additional plans required for FSO, FPSO, FPU, FSRU, MOSU:
- 1) pumping arrangement at the forward and after ends and drainage of cofferdams and pump rooms.
- h) Additional plans required in order to assign unattended machinery space notation:
- 1) instrument and alarm list;
 - 2) fire alarm system;
 - 3) list of automatic safety functions (e.g. slowdowns, shutdowns, etc.);
 - 4) function testing plan.

Alternative technical data may be accepted by the Society in lieu of specific items of the listed documentation not available at the time of the transfer of class.

Additional documentation may be required according to Flag Administration requirements.

3.6.3 Basic conditions of IACS Procedural Requirement PR1D (1/7/2015)

IACS Procedural Requirement PR1D contains procedures and requirements pertaining to class entry of units not subject to IACS Procedural Requirement PR1A or IACS Procedural Requirement PR1B and is applicable, unless stated otherwise, to units in service not classed with a QSCS Classification Society or not classed at all, of over 100 GT of whatever type, self-propelled or not, restricted or unrestricted service, except for "inland waterway" units.

Cases concerning units of 100 GT or less are dealt with by the Society on a case-by-case basis.

Cases concerning units to which the class is reassigned are to be dealt with according to [5].

Whenever the Society is requested by an Owner to accept a unit in service into class:

- a) the relevant surveys specified in Ch 3, Sec 2 [1.1.2] are to be satisfactorily completed for entry into class;
- b) the copies of the plans listed [3.6.2] are to be provided to the gaining Society as a prerequisite to obtaining an Interim or Full Term Certificate of Class.
- c) required plan appraisal is to be satisfactorily completed for entry into class.

3.6.4 Conditions of IACS Procedural Requirement PR1D, preventing issue of the Interim Certificate of Classification (1/7/2015)

Prior to issuing an Interim Certificate of Classification, the Society is to obtain a written request to class the unit from the Owner.

The Society cannot issue an Interim Certificate of Classification, or other documents enabling the unit to trade under its classification:

- a) until all required surveys specified in Ch 3, Sec 2 [3.1.2] have been completed.
- b) until the appraisal of the plans listed in [3.6.2] as required by the Society to verify compliance with its applicable classification Rules, has been carried out. Where issues remain outstanding, the Society may impose a Recommendation/Condition of Class for a limited period in accordance with Ch 2, Sec 2 [2.13].,
- c) attends tests and trials provided in the Rules.

3.6.5 Surveys (1/7/2015)

The Surveyor:

- a) checks that the outcome of the design assessment and survey instructions are available,
- b) surveys the unit to check that it complies with the outcome of the design assessment and with the applicable Rules,
- c) attends tests and trials provided for in the Rules.

3.6.6 Interim Certificate of Classification

Upon satisfactory completion of the survey for assignment of class, the Surveyor issues to the Owner an Interim Certificate of Classification valid not more than 5 months. This certificate indicates the class notations.

The certificate is issued with a Survey Endorsement Sheet where all outstanding recommendations and significant memoranda are recorded; class notations requested by the Owner and not assigned due to pending items are clearly indicated together with the relevant pending items.

3.6.7 Certificate of Classification

Upon satisfactory review of the survey reports, the Society issues to the Owner the Certificate of Classification valid for the whole period of class. The certificate indicates the class notations.

All outstanding recommendations, significant memoranda and pending items for class notations not assigned are made available in the survey status.

3.6.8 Equivalence criterion

Where appropriate within reasonable limits, a proven service record of satisfactory performance during a period of adequate length may be used as a criterion of equivalence. Special consideration will be given to units of recent construction.

3.6.9 Additional service and/or class notations

For installations or equipment covered by additional service and/or class notations, the Society will determine the documentation to be submitted.

3.6.10 Other documentation

In addition, the Society may base its judgement upon documentation such as certificates issued or accepted by the former Classification Society, if any, and statutory certificates issued by the flag Administration or by a recognised organisation on its behalf; moreover, other documents and/or

plans may be specifically required to be supplied to the Society in individual cases.

4 Date of initial classification

4.1 Definitions

4.1.1 Date of build

For a new building the date of build is the year, month and day at which the new construction survey process is completed.

Where there is a substantial delay between the completion of the construction survey process and the unit commencing active service, the date of commissioning may also be specified.

If modifications are carried out, the date of build remains assigned to the unit. Where a complete replacement or addition of a major portion of the unit (e.g. forward section, after section, main cargo section) is involved, the following applies:

- a) the date of build associated with each major portion of the unit is indicated on the Certificate of Classification
- b) survey requirements are based on the date of build associated with each major portion of the unit.

4.1.2 Date of initial classification for new buildings

As a general rule, for new buildings the date of initial classification coincides with the date of build.

4.1.3 Date of initial classification for existing units

In principle, for existing units the date of initial classification is the date of completion of the admission to class survey.

4.1.4 Period of class

The assigned period of class is never to exceed five (5) years. The 5-year period is granted only upon completion of the new building procedure and, for units classed after construction, upon satisfactory outcome of a survey with the scope of a renewal survey.

If a unit classed after construction was previously classed with a QSCS Classification Society [3.2], the assigned period of class is never to go beyond the due date of the renewal survey assigned by the previous Society.

5 Reassignment of class

5.1 Units in service classed by a QSCS Classification Society

5.1.1 Documentation to be submitted and design assessment

The requirements of [3.2.1] apply.

5.1.2 Conditions, Surveys and Certificate of Classification

The requirements of [3.2.2] to [3.2.7] apply.

5.2 Units in service not classed by an IACS Society

5.2.1 Documentation to be submitted and design assessment (1/7/2015)

The requirements of [3.6.2] apply.

5.2.2 Conditions, Surveys and Certificate of Classification (1/7/2015)

The requirements of [3.6.3] to [3.6.10] apply.

5.3 Units in service not classed by a QSCS Classification Society, but previously classified by a QSCS Classification Society

5.3.1 General

The following two cases are considered.

- a) the date of the class withdrawal, by the last QSCS Classification Society, falls within the time window of six months counted from the date of the classification request: the provisions of [5.1] apply;
- b) the date of the class withdrawal, by the last QSCS Classification Society, does not fall within the time window of six months counted from the date of the classification request: the provisions of [5.2] apply.

When the unit was previously classed by the Society and since the withdrawal of the Society's class no conversion or significant modification of the unit or alteration of the unit's class has been made, a design assessment may nevertheless be required.

5.4 Units no longer in service since class withdrawal by the Society

5.4.1 General (1/7/2015)

This paragraph is applicable, based on the premise that after the class was withdrawn by the Society, the unit:

- never resumed its trade
- has not been classified by any other Classification Society.

5.4.2 Conditions, Surveys and Certificate of Classification (1/7/2015)

The requirements of Ch 2, Sec 3, [1.4] apply.

5.5 Units no longer in service since class withdrawal by a QSCS Classification Society or by a non-QSCS Classification Society

5.5.1 Documentation to be submitted and design assessment (1/7/2015)

The requirements of [3.2.1] apply.

5.5.2 Conditions, Surveys and Certificate of Classification (1/7/2015)

The requirements of [3.2.2] to [3.2.7] apply.

6 Double or dual class procedure

6.1 Definitions

6.1.1 Double class (1/2/2021)

A double class unit is an existing one which is classed by two Societies, where each one acts independently when the unit is in service.

6.1.2 Dual class (1/2/2021)

A dual class unit is an existing one which is classed by two Societies and

- a) each Society acts on behalf of the other Society in accordance with the bilateral agreement adopted by the

two Societies. This agreement shall clearly define the scope of work of each Society;

- b) each Society is to review whether the work undertaken by other Society on its behalf has been completed as agreed.

6.2 Procedure

6.2.1 The procedure of admission to class of a unit already classed with another QSCS Classification Society under double or dual class arrangement is to be the same as that provided for single class arrangement.

SECTION 2 MAINTENANCE OF CLASS

1 General principles of surveys

1.1 Survey types

1.1.1 (1/7/2023)

Classed units are submitted to surveys for the maintenance of class. These surveys include the class renewal survey, intermediate and annual survey, bottom survey (either survey in dry condition or in-water survey), survey of propulsion systems, boiler survey, and surveys for the maintenance of additional class notations, where applicable. Such surveys are carried out at the intervals and under the conditions laid down in this Section. In addition to the above periodical surveys, units are to be submitted to occasional surveys whenever the circumstances so require; refer to [6].

1.1.2 The different types of periodical surveys are summarised in Tab 1. The intervals at which the periodical surveys are carried out are given in the items referred to in the second column of Tab 1. The relevant extent and scope are given in Chapter 3 and Chapter 4 for all units and for service notations, respectively, while surveys related to additional class notations are given in Chapter 5.

Where there are no specific survey requirements for additional class notations assigned to a unit, equipment and/or arrangements related to these additional class notations are to be examined, as applicable, to the Surveyor's satisfaction at each class renewal survey for the main class.

The surveys are to be carried out in accordance with the relevant requirements in order to confirm that the hull, machinery, equipment and appliances comply with the applicable Rules and will remain in satisfactory condition based on the understanding and assumptions mentioned in Ch 1, Sec 1, [3.3].

Where the conditions for the maintenance of main class, service notations and additional class notations are not complied with, the main class and/or the service notation and/or the additional class notations as appropriate will be suspended and/or withdrawn in accordance with the applicable Rules given in Sec3.

Note 1: It is understood that requirements for surveys apply to those items that are required according to the Rules or, even if not required, are fitted on board.

1.1.3 Unless specified otherwise, any survey other than bottom survey and propulsion systems may be performed by carrying out partial surveys at different times to be agreed upon with the Society, provided that each partial survey is adequately extensive. The splitting of a survey into partial surveys is to be such as not to impair its effectiveness.

1.2 Change of periodicity, postponement or advance of surveys

1.2.1 The Society reserves the right, after due consideration, to change the periodicity, postpone or advance surveys, taking into account particular circumstances.

Table 1 : List of periodical surveys

Type of survey	Reference in this Section	Reference to scope of survey
Class renewal - hull	[4]	Ch 3, Sec 5 and Chapter 4 (1)
Class renewal - machinery	[4]	Ch 3, Sec 5 and Chapter 4 (1)
Annual - hull	[5.2]	Ch 3, Sec 3 and Chapter 4 (1)
Annual - machinery	[5.2]	Ch 3, Sec 3 and Chapter 4 (1)
Intermediate - hull	[5.3]	Ch 3, Sec 4 and Chapter 4 (1)
Intermediate - machinery	[5.3]	Ch 3, Sec 4 and Chapter 4 (1)
Bottom - dry condition	[5.4]	Ch 3, Sec 6
Bottom - in water	[5.4]	Ch 3, Sec 6
Propulsion systems	[5.5]	Ch 4, Sec 5
Boiler - complete	[5.6]	Ch 3, Sec 7
(1) As applicable, according to the service notation assigned to the unit		

1.2.2 When a survey becomes overdue during a voyage, the following applies:

- a) In the case of a class renewal survey, the Society may, under exceptional circumstances, grant an extension to allow for completion of this survey provided there is documented agreement to such an extension prior to the expiry date of the Certificate of Classification, adequate arrangements have been made for the attendance of the Surveyor at the first port of call and the Society is satisfied that there is technical justification for such an extension. Such an extension will be granted only until arrival at the first port of call or location after the expiry date of the Certificate of Classification (only applicable to a self-propelled MODU)
- b) In the case of annual and intermediate surveys, no postponement is granted. Such surveys are to be completed within their prescribed windows; see [2.1.3]
- c) In the case of all other periodical surveys and recommendations, extension of class may be granted until the arrival of the unit at the port of destination or location (only applicable to a self-propelled MODU).

1.3 Extension of scope of survey

1.3.1 The Society and/or its Surveyors may extend the scope of the provisions in Chapter 3 to Chapter 5, which set forth the technical requirements for surveys, whenever and so far as considered necessary, or modify them in the case of special units or systems.

1.3.2 The extent of any survey also depends upon the condition of the unit and its equipment. Should the Surveyor have any doubt as to the maintenance or condition of the unit or its equipment, or be advised of any deficiency or damage which may affect the class, then further examination and testing may be conducted as considered necessary.

1.4 General procedure of survey

1.4.1 The general procedure of survey consists in:

- a) an overall examination of the parts of the unit covered by the rule requirements
- b) checking selected items covered by the rule requirements
- c) attending tests and trials where applicable and deemed necessary by the Surveyor.

1.4.2 The Society's survey requirements cannot be considered as a substitute for specification and acceptance of repairs and maintenance, which remain the responsibility of the Owner.

1.4.3 In accordance with the provisions of Ch 1, Sec 1, [3.1.5], the Society will, at the request of the Owner, apply the regulations of Administrations concerning the scope and periodicity of surveys when they differ from those laid down in Part A.

1.4.4 During the surveys, the Surveyor does not check that the spare parts are kept on board, maintained in working order and suitably protected and lashed.

1.4.5 As a general rule, all materials, machinery, boilers, auxiliary installations, equipment, items etc. (generally referred to as "products") which are covered by the class and used or fitted on board units inspected by the Society during surveys after construction are to be new and, where intended for essential services as defined in Ch 1, Sec 1, [1.2.1], tested by the Society.

Second hand materials, machinery, appliances and items may be used subject to the specific agreement of the Society and the Owner.

The requirements for the selection of materials to be used in the construction or repair of the various parts of existing units, the characteristics of products to be used for such parts and the checks required for their acceptance are to be as stated in Part C and Part D, as applicable, or in other Parts of the Rules or as specified on approved plans. In particular, the testing of products manufactured according to quality assurance procedures approved by the Society and the approval of such procedures are governed by the requirements of Pt D, Ch 1, Sec 1, [3] of the Rules for the Classification of Ships.

1.5 Appointment of another Surveyor

1.5.1 In compliance with the provisions of Ch 1, Sec 1, [2.6.1], should a disagreement arise between the Owner and the Surveyor during a survey, the Society may, at the request of the Owner, designate another Surveyor.

2 Definitions and procedures related to surveys

2.1 General

2.1.1 Period of class

Period of class means the period starting either from the date of the initial classification, see Sec 1, [5], or from the credited date of the last class renewal survey, and expiring at the limit date assigned for the next class renewal survey.

2.1.2 Anniversary date

Anniversary date means the day of the month of each year in the period of class which corresponds to the expiry date of the period of class.

2.1.3 Survey time window

Survey time window, or more simply window, mean the fixed period during which annual and intermediate surveys are to be carried out.

2.1.4 Overdue surveys

Each periodical survey is assigned a limit date specified by the relevant requirements of the Rules (end of survey interval or end date of window) by which it is to be completed.

A survey becomes overdue when it has not been completed by its limit date.

Examples:

a) Anniversary date: 15th April

The 2010 annual survey can be validly carried out from 16th January 2010 to 15th July 2010. If not completed by 15th July 2010, the annual survey becomes overdue.

b) Last bottom survey 20th October 2010 (periodicity 2.5 years, with a maximum interval between successive examinations not exceeding 3 years)

The next bottom survey is to be carried out before 20th October 2013. If not completed by 20th October 2013, the bottom survey becomes overdue.

2.1.5 Recommendations

A recommendation is a requirement to the effect that specific measures, repairs and/or surveys are to be carried out within a specific time limit in order to retain classification. A recommendation is pending until it is cleared. Where it is not cleared by its limit date, the recommendation is overdue.

2.1.6 Memoranda

Those defects and/or deficiencies which do not affect the maintenance of class and which may therefore be cleared at the Owner's convenience and any other information deemed noteworthy for the Society's convenience are indicated as memoranda. Memoranda are not to be regarded as recommendations.

2.1.7 Exceptional circumstances

Exceptional circumstances' means unavailability of dry-docking facilities; unavailability of repair facilities; unavailability of essential materials, equipment or spare parts; or delays incurred by action taken to avoid severe weather conditions.

2.1.8 Force Majeure

'Force Majeure' means damage to the unit; unforeseen inability of the Society to attend the unit due to government restrictions on right of access or movement of personnel; unforeseeable operational limitations or inability to discharge cargo due to unusually lengthy periods of severe weather, strikes or civil strife; acts of war; or other force majeure.

2.2 Terminology related to hull survey**2.2.1 Ballast tanks**

A Ballast Tank is a tank that is being used primarily for salt water ballast. A space which is used for both storage of liquids and salt-water ballast will be treated as a Ballast tank when substantial corrosion has been found in that space.

2.2.2 Spaces

Spaces are separate compartments including holds, tanks, cofferdams and void spaces bounding cargo holds, decks and the outer hull.

2.2.3 Overall survey

An overall survey is a survey intended to report on the overall condition of the hull structure and determine the extent of additional close-up surveys..

2.2.4 Close-up survey

A close-up survey is a survey where the details of structural components are within the close visual inspection range of the Surveyor, i.e. normally within reach of hand.

2.2.5 Transverse section

A transverse section includes all longitudinal members contributing to longitudinal hull girder strength, such as plating, longitudinals and girders at the deck, side shell, bottom, inner bottom, longitudinal bulkheads, and sloped plating in upper and lower side tanks, as well as relevant longitudinals, as applicable for the different units. For a transversely framed unit, a transverse section includes adjacent frames and their end connections in way of transverse sections.

2.2.6 Representative tanks or spaces

Representative tanks or spaces are those which are expected to reflect the condition of other tanks or spaces of similar type and service and with similar corrosion prevention systems. When selecting representative tanks or spaces, account should be taken of the service and repair history on board and identifiable critical structural areas and/or suspect areas.

2.2.7 Substantial corrosion

Substantial corrosion is an extent of corrosion such that assessment of the corrosion pattern indicates a wastage in excess of 75% of allowable margins, but within acceptable limits.

For units which are assigned the additional class notation **CSR**, substantial corrosion is an extent of corrosion such that the assessment of the corrosion pattern indicates a gauged (or measured) thickness between $t_{net} + 0,5\text{mm}$ and t_{net} .

2.2.8 Suspect areas

Suspect areas are locations showing substantial corrosion and/or considered by the Surveyor to be prone to rapid wastage.

For MODU, suspect areas are locations considered by the Surveyor to be prone to rapid wastage.

2.2.9 Critical Structural Area

Critical Structural Areas are locations which have been identified from calculations to require monitoring and/or which, from the service history of the subject unit or from similar or sister units (if available), have been identified as sensitive to cracking, buckling or corrosion which would impair the structural integrity of the unit.

2.2.10 Corrosion Prevention System (1/1/2016)

A Corrosion Prevention System is normally considered a full hard protective coating.

Hard Protective Coating is usually to be epoxy coating or equivalent. Other coating systems which are neither soft nor semi-hard coatings may be considered acceptable as alternatives provided that they are applied and maintained in compliance with the Manufacturer's specifications.

2.2.11 Coating condition

Coating condition is defined as follows:

- good: condition with only minor spot rusting
- fair: condition with local breakdown at edges of stiffeners and weld connections and/or light rusting over 20% or more of areas under consideration, but less than as defined for poor condition
- poor: condition with general breakdown of coating over 20% or more of areas or hard scale at 10% or more of areas under consideration.

2.2.12 Cargo area (for FSO and FPSO)

The cargo area is that part of the unit which contains cargo tanks, slop tanks and cargo/ballast pump rooms, cofferdams, ballast tanks and void spaces adjacent to cargo tanks and also deck areas throughout the entire length and breadth of the part of the unit over the above-mentioned spaces.

2.2.13 Cargo length area (for MODU)

The cargo length area is that part of the unit which includes all cargo holds and adjacent areas including fuel tanks, cofferdams, ballast tanks and void spaces.

2.2.14 Cargo area (for FSRU)

Cargo area is that part of the unit which contains cargo tanks, cargo/ballast pump rooms, compressor rooms, cofferdams, ballast tanks and void spaces adjacent to cargo tanks and also deck areas throughout the entire length and breadth of the part of the unit over the above-mentioned spaces.

2.2.15 Prompt and Thorough Repair

A Prompt and Thorough Repair is a permanent repair completed at the time of survey to the satisfaction of the Surveyor, therein removing the need for the imposition of any associated recommendation.

2.2.16 Special consideration

Special consideration or specially considered (in connection with close-up surveys and thickness measurements) means sufficient close-up inspection and thickness measurements are to be taken to confirm the actual average condition of the structure under the coating..

2.2.17 Air pipe heads

Air pipe heads installed on exposed decks are those extending above the freeboard deck or superstructure decks.

2.2.18 Independent double bottom tank

An independent double bottom tank is a double bottom tank which is separate from topside tanks, side tanks or deep tanks.

2.2.19 Preload tank (1/1/2016)

A Preload Tank is a tank within the hull of a self-elevating unit. These tanks are periodically filled with salt water ballast and used to preload the footings of the unit prior to commencing drilling operations. Preload Tanks are considered equivalent to Ballast Tanks.

2.2.20 Remote Inspection Technique (1/7/2019)

Remote Inspection Technique (RIT) is a means of survey that enables examination of any part of the structure without the need for direct physical access of the Surveyor. Remote Inspection Technique may include the use of unmanned robot arm, Remotely Operated Vehicles (ROV), unmanned aerial vehicles/drones or other means acceptable to the Society.

2.3 Procedural requirements for thickness measurements

2.3.1 Control of the process

When required as per the scope of surveys defined below, thickness measurements are normally to be carried out under the responsibility of the Owner, in the presence of the Surveyor.

The thickness measurements required, if not carried out by the Society itself are to be witnessed by a Surveyor of the Society. The Surveyor is to be on board to the extent necessary to control the process.

This also applies to thickness measurements taken during voyages or while the unit is at an offshore location. The attendance of the Surveyor will be recorded.

Note 1: Also refer to IACS Recommendation no. 77 "Guidelines for the Surveyor on how to control the thickness measurement process".

2.3.2 Survey meeting

Prior to commencement of the intermediate and class renewal surveys, a meeting is to be held between the attending Surveyor(s), the master of the unit or an appropriately qualified representative appointed by the master or Company, the Owner's representative(s) in attendance and the thickness measurement firm's representative(s) so as to ensure the safe and efficient execution of the surveys and thickness measurements to be carried out on board.

Communication with the thickness measurement operator(s) and Owner's representative(s) is to be agreed during the meeting, with respect to the following:

- a) reporting of thickness measurements on a regular basis
- b) prompt notification to the Surveyor in the case of findings
 - 1) excessive and/or extensive corrosion or pitting/grooving of any significance
 - 2) structural defects like buckling, fractures and deformed structures
 - 3) detached and/or holed structure
 - 4) corrosion of welds.

When thickness measurements are taken in association with intermediate or renewal survey, a documented record indicating where and when the meeting took place and who attended (the name of the surveyor(s), the master of the unit or an appropriately qualified representative appointed by the master or Company, the owner's representative(s) and the representative(s) of the thickness measurement firm(s)) is to be maintained.

2.3.3 Thickness measurements and close-up surveys (1/7/2019)

In any kind of survey, i.e. renewal, intermediate, annual or other surveys having the scope of the foregoing, thickness measurements of structures in areas where close-up surveys are required are to be carried out simultaneously with close-up surveys.

Consideration may be given by the Surveyor to allow use of Remote Inspection Techniques (RIT) as an alternative to close-up survey. Surveys conducted using a RIT are to be completed to the satisfaction of the Surveyor. When RIT is used for a close-up survey, temporary means of access for the corresponding thickness measurements are to be provided unless such RIT is also able to carry out the required thickness measurements.

The extent and frequency of thickness measurement on structure with substantial corrosion will be specially considered. The survey will not be considered complete until all required thickness measurements have been carried out.

The Surveyor may extend the scope of thickness measurements if deemed necessary.

In all cases the extent of the thickness measurements is to be sufficient as to represent the actual average condition.

2.3.4 Approval of thickness measurements firms

Thickness measurements are to be carried out by a firm approved by the Society in accordance with the "Rules for the Certification of Service Suppliers".

2.3.5 Monitoring of the thickness measurement process on board

The Surveyor will decide the final extent and location of thickness measurements after overall survey of representative spaces on board.

If the Owner prefers to commence the thickness measurements prior to the overall survey then the Surveyor will advise that the planned extent and locations of thickness measurements are subject to confirmation during the overall survey.

Based on findings, the Surveyor may require additional thickness measurements to be taken.

The Surveyor will direct the gauging operation by selecting locations such that, on average, readings taken represent the condition of the structure for that area.

Thickness measurements taken mainly to evaluate the extent of corrosion which may affect the hull girder strength are to be carried out systematically in all longitudinal structural members that are required to be gauged by the relevant provisions of the Rules.

Where thickness measurements indicate substantial corrosion or wastage in excess of allowable diminution, the Surveyor will direct locations for additional thickness measurements in order to delineate areas of substantial corrosion and to identify structural members for repairs/renewals.

2.3.6 Review and verification

Upon completion of the thickness measurements, the Surveyor will confirm that no further gaugings are needed, or specify additional gaugings.

If, where special consideration is allowed by the Rule requirements, the extent of thickness measurements is reduced, the Surveyor's special consideration will be reported.

If thickness measurements are partly carried out, the extent of the remaining measurements will be reported for the use of the next Surveyor.

2.3.7 Thickness measurement report

A thickness measurement report is to be prepared. The report is to give the location of measurements, the thickness measured and the corresponding original thickness. Furthermore, the report is to include the date when the measurements were carried out, the type of measuring equipment, the names and the qualification of the operators and their signatures.

The report is validated by the Surveyor.

2.3.8 Acceptance criteria

For acceptance criteria applicable to structural corrosion diminution levels, reference is to be made to App 2.

2.3.9 Evaluation of longitudinal strength

The unit's longitudinal strength is to be evaluated by using the thickness of structural members measured, renewed and reinforced, as appropriate, during the class renewal survey carried out after the unit reached 10 years of age in accordance with the criteria for longitudinal strength of the unit's hull girder specified in App 2, [4.3.5].

2.4 Agreement of firms for in-water survey

2.4.1 (1/7/2019)

The in-water surveys referred to in the Rules are to be carried out by a firm approved by the Society in accordance with the "Rules for the Certification of Service Suppliers".

2.5 Conditions for surveys

2.5.1 The Owner is to provide the necessary facilities for the safe execution of the surveys, as per Ch 1, Sec 1, [3.2.2].

- a) In order to enable the attending Surveyors to carry out the survey, provisions for proper and safe access are to be agreed between the Owner and the Society;
- b) in cases where the provisions made for safety and required access are judged by the attending Surveyors to be inadequate, the survey of the spaces involved is not to proceed.

2.5.2 Tanks and spaces are to be safe for access, gas-free and properly ventilated. Prior to entering a tank, void or enclosed space, it is to be verified that the atmosphere in that space is free from hazardous gas and contains sufficient oxygen.

2.5.3 In preparation for survey and thickness measurements and to allow for a thorough examination, all

spaces are to be cleaned, including removal from surfaces of all loose accumulated corrosion scale. Spaces are to be sufficiently clean and free from water, scale, dirt, oil residues etc. to reveal corrosion, deformation, fractures, damage, or other structural deterioration as well as the condition of the coating. However, those areas of structure whose renewal has already been decided by the Owner need only be cleaned and descaled to the extent necessary to determine the limits of the areas to be renewed.

2.5.4 Sufficient illumination is to be provided to reveal corrosion, deformation, fractures, damage or other structural deterioration.

2.5.5 When examination of associated structure is required, the following applies:

- a) ceilings in holds and floors in the engine room are to be lifted to the necessary extent for examination of the structure
- b) cement or other protective sheathing is to be removed when there is any doubt as to the condition of the plating underneath or when adherence to plating is not tight
- c) in the case of solid ballast spaces, the solid ballast is to be partially removed for examination of the condition of the structure in way. Should doubts arise, the Surveyor may require more extensive removal of the solid ballast
- d) insulation of compartments intended for refrigerated cargoes is to be removed over the necessary extent for examination by the Surveyor of the condition of the structure, unless constructional arrangements make such inspections possible without removing the insulation
- e) where soft coatings have been applied, safe access is to be provided for the Surveyor to verify the effectiveness of the coating and to carry out an assessment of the conditions of internal structures which may include spot removal of the coating. When safe access cannot be provided, the soft coating is to be removed.

2.5.6 Surveyors are to always be accompanied by at least one responsible person, assigned by the Owner, experienced in tank and enclosed space inspection. In addition, a backup team of at least two experienced persons is to be stationed at the hatch opening of the tank or space that is being surveyed. The backup team is to continuously observe the work in the tank or space and is to keep life-saving and evacuation equipment ready for use.

2.5.7 A communication system is to be arranged between the survey party in the tank or space being examined, the responsible Officer on deck and, as the case may be, the navigation bridge. The communication arrangements are to be maintained throughout the survey.

2.6 Surveys by use of a Remote Inspection Technique (RIT)

2.6.1 (1/7/2019)

The survey conducted by use of a RIT is to provide the information normally obtained from a close-up survey.

An inspection plan for the use of a RIT, including any confirmatory survey/close-up survey/thickness measurements, is to be submitted for review and acceptance in advance of the survey, so that satisfactory arrangements can be agreed on with the Society.

Prior to the commencement of the survey, a meeting is to be held between the RIT operator, the owner's representative and the Surveyor for the purpose of ascertaining that all the arrangements detailed in the inspection plan are in place, so as to ensure the safe and efficient conduct of the survey to be carried out. The equipment and procedure for observing and reporting the survey using a RIT are to be discussed and agreed with the parties involved prior to the RIT survey, and suitable time is to be allowed to set-up, calibrate and test all equipment beforehand.

A RIT survey used as an alternative to a close-up survey, if not carried out by the Society itself, is to be conducted by a firm approved by the Society in accordance with the "Rules for the Certification of Service Suppliers" and to be witnessed by a Surveyor of the Society.

The structures to be examined using a RIT are to be sufficiently clean and the visibility is to be sufficient, to permit a meaningful examination. The Society is to be satisfied with the methods of orientation on the structures.

The Surveyor is to be satisfied with the method of data presentation including pictorial representation, and a good two-way communication between the Surveyor and the RIT operator is to be provided.

Confirmatory surveys/close-up surveys may be carried out by the Surveyor at selected locations to verify the results of the remote inspection technique.

Confirmatory thickness measurements may be requested by the Surveyor appropriately.

The use of RIT may be restricted or limited where there is a record or indication of abnormal deterioration or damage to the structures or the items to be surveyed.

The RIT may not be applicable if there are recommendations for repairs or conditions affecting the class of the vessel are found during the course of the survey.

If the RIT reveals damage or deterioration that requires attention, the Surveyor may require traditional survey without the use of a RIT to be undertaken.

2.7 Access to structures

2.7.1 Means are to be provided to enable the Surveyor to examine the structure in a safe and practical way.

2.7.2 For close-up survey, one or more of the following means for access, acceptable to the Surveyor, is to be provided:

- permanent staging and passages through structures
- temporary staging and passages through structures
- lifts and moveable platforms
- boats or rafts
- portable ladders
- other equivalent means.

2.7.3 (1/7/2019)

For surveys conducted by use of a Remote Inspection Technique, one or more of the following means for access, acceptable to the Surveyor, is to be provided:

- unmanned robot arm
- Remotely Operated Vehicles (ROV)
- unmanned aerial vehicles / drones
- other means acceptable to the Society.

2.8 Equipment for surveys

2.8.1 One or more of the following fracture detection methods may be required if deemed necessary by the Surveyor:

- radiography (X or γ rays)
- ultrasonic test
- magnetic particle test
- dye penetrant test.

2.8.2 Thickness measurement is normally to be carried out by means of ultrasonic test equipment. The accuracy of the equipment is to be proven to the Surveyor as required.

2.8.3 Explosimeter, oxygen-meter, breathing apparatus, lifelines, riding belts with rope and hook and whistles together with instructions and guidance on their use are to be made available during the survey. A safety checklist is to be provided.

2.8.4 Adequate and safe lighting is to be provided for the safe and efficient conduct of the survey.

2.8.5 Adequate protective clothing (e.g. safety helmet, gloves, safety shoes, etc) is to be made available and used during the survey.

2.9 Rescue and emergency response equipment**2.9.1 (1/1/2016)**

If breathing apparatus and/or other equipment is used as rescue and emergency response equipment then it is recommended that the equipment be suitable for the configuration of the space being surveyed.

2.10 Procedure of survey

2.10.1 Surveys at an offshore location or anchorage may be accepted provided the Surveyor is given the necessary assistance by the personnel on board. Precautions and procedures for carrying out the survey are to be in accordance with [2.5], [2.6] and [2.7].

2.10.2 A communication system is to be arranged between the survey party in the tank or space and the responsible officer on deck.

This system is also to include the personnel in charge of ballast pump handling if boats or rafts are used.

2.10.3 Surveys of tanks by means of boats or rafts may only be undertaken with the agreement of the Surveyor, who is to take into account the safety arrangements

provided, including weather forecasting and unit response under foreseeable conditions and provided the expected rise of water within the tank does not exceed 0,25m.

2.10.4 When rafts or boats are used for close-up survey, the following conditions are to be observed:

- a) only rough duty, inflatable rafts or boats, having satisfactory residual buoyancy and stability even if one chamber is ruptured, are to be used;
- b) the boat or raft is to be tethered to the access ladder and an additional person is to be stationed down the access ladder with a clear view of the boat or raft;
- c) appropriate lifejackets are to be available for all participants;
- d) the surface of water in the tank is to be calm (under all foreseeable conditions the expected rise of water within the tank is to not exceed 0,25 m) and the water level stationary. On no account is the level of the water to be rising while the boat or raft is in use;
- e) the tank, hold or space is to contain clean ballast water only. Even a thin sheen of oil on the water is not acceptable;
- f) at no time is the water level to be allowed to be within 1 m of the deepest under deck web face flat so that the survey team is not isolated from a direct escape route to the tank hatch. Filling to levels above the deck transverses is only to be contemplated if a deck access manhole is fitted and open in the bay being examined, so that an escape route for the survey party is available at all times. Other effective means of escape to the deck may be considered;
- g) if the tanks (or spaces) are connected by a common venting system, or inert gas system, the tank in which the boat or raft is to be used is to be isolated to prevent a transfer of gas from other tanks (or spaces).

2.11 Repairs and maintenance during operation

2.11.1 Where repairs to hull, machinery or other equipment, which affect or may affect the class, are to be carried out by a riding crew during the operation of the unit, they are to be planned in advance. A complete repair procedure including the extent of proposed repair and the need for the Surveyor's attendance during the operation is to be submitted to the Society for approval sufficiently in advance. Failure to notify the Society in advance of the repairs may result in the suspension of class of the unit.

2.11.2 The above is not intended to include maintenance to and overhaul of the hull, machinery and equipment in accordance with the Manufacturer's recommended procedures and established marine practice, which does not require the Society's agreement. However, any repair resulting from such maintenance and overhauls which affects or may affect the class is to be noted in the unit's log and submitted to the attending Surveyor for use in determining further survey requirements.

2.11.3 (1/1/2016)

Where the damage mentioned in [2.10.1] is isolated and of a localised nature which does not affect the unit's structural integrity, consideration may be given by the surveyor to

allow an appropriate temporary repair to restore watertight or weather tight integrity and impose a Recommendation/Condition of Class in accordance with IACS PR 35, with a specific time limit.

2.12 Prompt and thorough repairs

2.12.1 Any damage in association with wastage over the allowable limits (including buckling, grooving, detachment or fracture), or extensive areas of wastage over the allowable limits, which affects or, in the opinion of the Surveyor, will affect the unit's structural, watertight or weathertight integrity, is to be promptly and thoroughly (see [2.2.15]) repaired. Areas to be considered include, as far as applicable, the following:

- a) side structure and side plating;
- b) deck structure and deck plating;
- c) bottom structure and bottom plating
- d) inner bottom structure and inner bottom plating;
- e) inner side structure and inner side plating;
- f) longitudinal bulkhead structure and longitudinal bulkhead plating, where fitted;
- g) transverse watertight or oiltight bulkhead structure and transverse watertight or oiltight bulkheads plating;
- h) hatch covers and hatch coamings, where fitted;
- i) weld connection between air pipes and deck plating;
- j) air pipe heads installed on the exposed decks;
- k) ventilators, including closing devices, if any;
- l) pontoon shell framing and attached plating;
- m) bracing and end connections;
- n) primary upper hull structure.

For locations where adequate repair facilities are not available, consideration may be given to allow the vessel to proceed directly to a repair facility. This may require discharging the cargo and/or temporary repairs for the intended voyage.

2.12.2 Additionally, when a survey results in the identification of structural defects or corrosion, either of which, in the opinion of the Surveyor, will impair the vessel's fitness for continued service, remedial measures are to be implemented before the unit continues in service.

2.13 Planned survey program

2.13.1 The Owner is to prepare a planned survey program for the inspection of the hull/structure after each class renewal survey before the next annual survey is due. The planned survey program is to cover the requirements for annual surveys, intermediate surveys, class renewal surveys, continuous surveys, dry docking surveys and in-water surveys in lieu of dry docking surveys and is to be submitted to the Society for review. A copy is to be kept on board and made available to the surveyor. The program is to include plans, etc., for identifying the areas to be surveyed, the extent of hull cleaning, locations for non-destructive examination (including NDE methods), nomenclature, and methods for the recording of any damage or deterioration

found. The program is to include guidance for control and recording of all relevant aspects of the inspection and replacement philosophy. In particular the program is to include and address the following:

- a) the overall design configuration;
- b) field life potential;
- c) appropriate regulatory requirements;
- d) main hull structural arrangement plans;
- e) details of planning, identification and preparation procedures;
- f) areas to be surveyed and extent of hull cleaning;
- g) inspection and testing schedules for all relevant compartments, equipment and systems;
- h) inspection methods and procedures;
- i) extent, frequency and circumstances for application of NDE;
- j) locations for non-destructive testing;
- k) schedule for overall survey, close-up survey and thickness measurement;
- l) condition of coatings and corrosion prevention systems;
- m) methods for reporting and recording of damage or deterioration found and remedial measures.

2.13.2 Particular attention is to be paid to critical areas and also to areas of suspected damage or deterioration and to repaired areas. Surveys are to take into account locations highlighted by service experience and the design assessment.

2.13.3 A planned survey program for positional mooring systems is to be developed by the Owner and submitted to the Society for approval; see Ch 3, Sec 3, [3.5.1].

2.13.4 The planned survey program as agreed by the Society will be subject to revision if found to be necessary at subsequent surveys or when required by the surveyor.

2.14 Procedure for imposing and clearing recommendations

2.14.1 Reasons for imposing recommendations

Recommendations are to be imposed for the following reasons:

- a) repairs and/or renewals related to damage that affect classification (e.g. grounding, structural damage, machinery damage, wastage over the allowable limits, etc.);
- b) supplementary survey requirements;
- c) temporary repairs.

2.14.2 Recommendations for repairs

For repairs not completed at the time of survey, a recommendation is to be imposed. In order to provide adequate information to the Surveyor attending for survey of the repairs, the recommendation is to be sufficiently detailed with identification of items to be repaired. For identification of extensive repairs, reference may be given to the survey report.

2.14.3 Recommendations with service limitations

Recommendations may require imposing limitations related to navigation (applicable to a self-propelled MODU) and operation that are deemed necessary for continued operation under classification (e.g. loss of anchor and/or chain, etc.).

2.14.4 Issue of recommendations

Recommendations are to be given in writing with a time limit for completion to the Owner's representatives/Master, and are to be clearly stated on the Certificate of Classification or an attachment to the Certificate of Classification and/or class survey status or report.

2.14.5 Notification of recommendations

Owners will be notified of these dates and that the unit's class will be subject to a suspension procedure if the item is not dealt with, or postponed, by the due date (refer to Sec 3, [1.2.11]).

2.14.6 Clearance of recommendations

Clearance of recommendations is to be supported by a survey report giving details of all associated repairs and/or renewals, or of the supplemental surveys carried out. Repairs carried out are to be reported with identification of:

- a) compartment and location
- b) structural member
- c) repair method
- d) repair extent
- e) NDT/Tests.

2.14.7 Recommendations partially dealt with

Partially dealt with recommendations are to be supported by a survey report giving details of repairs and/or renewals, or of that part of the supplemental surveys carried out and those parts remaining outstanding.

3 Certificate of Classification: issue, validity, endorsement and renewal**3.1 Issue of Certificate of Classification**

3.1.1 A Certificate of Classification, bearing the class notations assigned to the unit and an expiry date, is issued to any classed unit.

3.1.2 An Interim Certificate of Classification may serve as a Certificate of Classification in some cases, such as after an admission to class survey, or when the Society deems it necessary.

3.1.3 The Certificate of Classification or Interim Certificate of Classification is to be made available to the Society's Surveyors upon request.

3.2 Validity of Certificate of Classification, maintenance of class

3.2.1 According to Ch 1, Sec 1, [2.5], the Society alone is qualified to confirm the class of the unit and the validity of its Certificate of Classification.

3.2.2 During the class period, a Certificate of Classification is valid when it is not expired.

The class is maintained during a certain period or at a given date, when during the said period or at such date the conditions for suspension or withdrawal of class are not met.

3.2.3 At the request of the Owner, a statement confirming the maintenance of class may be issued by the Society based on the information in its records for that unit at the time.

This statement is issued on the assumption that the Owner has complied with the Rules, in particular with [6].

Should any information which would have prevented the Society from issuing the statement and which was not available at the time subsequently come to light, the statement may be cancelled.

Attention is drawn to Sec 3, [1.2], whereby the Society, upon becoming aware of a breach of the Rules, is empowered to suspend class from the date of the breach, which may be prior to the date of the statement.

3.2.4 According to the same conditions as in [3.2.3], a statement declaring that the class is maintained "clean and free from recommendation" may be issued by the Society when there is no pending recommendation at that date.

3.2.5 Classification-related documents and information are liable to be invalidated by the Society whenever their object is found to differ from that on which they were based or to be contrary to the applicable requirements. The Owner is liable for any damage which may be caused to any third party from improper use of such documents and information.

3.3 Endorsement of Certificate of Classification**3.3.1 Text of endorsement**

When surveys are satisfactorily carried out, the Certificate of Classification is generally endorsed accordingly.

Each endorsement normally consists of a description summarising the surveys held and a conclusion stating the consequent class position of the unit.

In special cases the endorsement may include additional indications such as modifications to classification notations, limits imposed on navigation, special restrictions, etc.

3.3.2 Possible modifications to endorsements

The Society reserves the right to modify the endorsements made by Surveyors.

3.4 Status of surveys and recommendations

3.4.1 Information given in the Certificate of Classification, associated endorsements, Rules and specific documents enables the Owner to identify the status of surveys and recommendations.

3.4.2 The omission of such information does not absolve the Owner from ensuring that surveys are held by the limit dates and pending recommendations are cleared to avoid

any inconvenience which is liable to result from the suspension or withdrawal of class; see Sec 3.

4 Class renewal survey

4.1 General principles

4.1.1 The first class renewal survey is to be completed within 5 years from the date of the initial classification survey and thereafter 5 years from the credited date of the previous class renewal survey. However, consideration may be given by the Society to granting an extension for a maximum of three months after the limit date, in exceptional circumstances and provided that the unit is attended and the attending Surveyor so recommends. In such cases the next period of class will start from the limit date for the previous class renewal survey before the extension was granted..

4.1.2 For surveys completed within three months before the limit date of the class renewal survey, the next period of class will start from this limit date. For surveys completed more than three months before the limit date, the period of class will start from the survey completion date.

4.1.3 A new period of class is assigned to the unit after the satisfactory completion of the class renewal survey, and a new Certificate of Classification with relevant annexes is issued for the new period of class.

4.1.4 Concurrent crediting to both intermediate survey and class renewal survey for surveys and thickness measurements of spaces is not acceptable.

4.1.5 For MODU, when considered necessary by the Society the interval between class renewal surveys may be reduced.

4.1.6 For MODU, class renewal survey requirements of units of unusual design, in lay-up or in unusual circumstances will be determined on individual basis.

4.2 Normal system

4.2.1 When the normal system is applied, the class renewal survey may be commenced at the fourth annual survey and continued during the following year with a view to completion by its due date. In this case the survey may be carried out by partial surveys at different times. The number of checks to be performed at each partial survey and the interval between partial surveys are to be agreed by the Society. In general, the first partial survey should include a significant number of thickness measurements, where required by the Rules.

4.2.2 A class renewal survey may be commenced before the fourth annual survey at the request of the Owner. In this case, the survey is to be completed within fifteen months. The conditions for the execution of partial surveys are the same as those referred to in [4.2.1].

4.3 Continuous survey system

4.3.1 The request by the Owner for admission to the continuous survey system will be considered by the Society and agreement depends on the type and age of hull and machinery. This system may apply to the class renewal survey of hull (CHS) and/or machinery (CMS).

4.3.2 The continuous survey system is not applicable to the class renewal survey of the hull of units over 20 years old. However, consideration may be given, at the discretion of the Society, to the applicability of the continuous survey system to the class renewal survey of the hull of units over 20 years old.

4.3.3 For units more than 10 years of age, the ballast tanks are to be internally examined twice in each five-year class period, i.e. once within the scope of the intermediate survey and once within the scope of the continuous system for the class renewal survey of hull.

4.3.4 When the continuous survey system is applied, appropriate notations are entered in the Register of Ships.

4.3.5 Units subject to the continuous survey system are provided with lists of items to be surveyed under this system.

4.3.6 For items inspected under the continuous survey system, the following requirements generally apply:

- a) the interval between two consecutive surveys of each item is not to exceed five years
- b) the items are to be surveyed in rotation, so far as practicable ensuring that approximately equivalent portions are examined each year
- c) the Society may credit for continuous survey results of inspections carried out before the admission to the continuous survey scheme
- d) each item is to be surveyed at one time, as far as practicable; the Society may, however, allow possible repair work to be carried out within a certain period
- e) the Surveyor may, at his discretion, extend the inspection to other items, if previous inspections carried out revealed any defects.

4.3.7 For units under continuous survey, items not included in the continuous survey cycle are to be inspected according to the provisions given in [4.2].

4.3.8 Upon application by the Owner, the Society may agree, subject to certain conditions, that some items of machinery which are included in the continuous survey cycle are examined by the Chief Engineer where the Society is not represented. The Chief Engineer is to be certified for this purpose by the Society and his examination is to be followed by a confirmatory survey carried out by a Surveyor. The conditions for the application of this procedure are given in App1.

4.3.9 Units on the continuous survey system are not exempt from other periodicals surveys..

4.3.10 A general examination of the unit, as detailed in Ch 3, Sec 3 for annual surveys, is to be carried out at the end of the period of class.

4.3.11 The survey in dry dock may be held at any time within the five-year class period, provided all the requirements of Ch 3, Sec 6, [2] are also complied with.

4.3.12 For laid-up units, specific requirements given in [8.1] apply.

4.3.13 The continuous survey system may be discontinued at any time at the discretion of the Society, or at the request of the Owner, and a specific arrangement devised.

4.4 Planned maintenance scheme (PMS/CBM) for machinery

4.4.1 A planned maintenance scheme may be considered as an alternative to the continuous survey system for machinery and is limited to components and systems covered by it. When such a system approved by the Society is implemented, a survey scheme other than those normally adopted and with intervals different from those of the continuous survey system as detailed in [4.3] may be accepted.

4.4.2 The conditions for approval of the planned maintenance scheme, the determination of survey item intervals and the general scope of surveys are detailed in Pt F, Ch 1, Sec 1.

4.4.3 When the planned maintenance scheme is applied, the notation **PMS** is entered on the Certificate of Classification and in the Register of Ships.

4.4.4 The planned maintenance scheme does not supersede the annual surveys and other periodical surveys.

4.4.5 A general examination of the machinery, as detailed in Ch 3, Sec 3 for annual surveys, is to be carried out at the end of the period of class.

4.4.6 The planned maintenance scheme may be discontinued at any time at the discretion of the Society, or at the request of the Owner, and a specific arrangement devised.

5 Other periodical surveys

5.1 General

5.1.1 The different types of periodical surveys are summarised in Tab 1.

5.2 Annual surveys

5.2.1 In the five-year period of class, five annual surveys are to be carried out. The first to fourth annual surveys have a six-month window, i.e. from three months before to three months after each anniversary date, while the fifth annual survey has only a three-month window, i.e. from three months before to the fifth anniversary date.

5.3 Intermediate surveys

5.3.1 An intermediate survey, where applicable, is to be carried out within the window from three months before the second to three months after the third anniversary date.

5.3.2 The intermediate survey is applicable at any period of class to all units that are five years old and over.

5.3.3 The internal examination of ballast spaces, overall and/or close-up survey of ballast spaces and cargo holds or tanks, as applicable, carried out at the 2nd or 3rd annual survey are also credited towards the intermediate survey.

5.3.4 Concurrent crediting to both intermediate survey and class renewal survey for surveys and thickness measurements of spaces is not acceptable..

5.4 Bottom survey

5.4.1 Bottom survey means the examination of the outside of the unit's bottom and related items. This examination may be carried out with the unit either in dry dock (or on a slipway) or afloat: in the former case the survey will be referred to as dry-docking survey, while in the latter case as in-water survey.

5.4.2 The Owner is to notify the Society whenever the outside of the unit's bottom and related items can be examined in dry dock or on a slipway.

5.4.3 There is to be a minimum of two examinations of the outside of the unit's bottom and related items during each five-year class renewal survey period. One such examination is to be carried out in conjunction with the class renewal survey. In all cases the interval between any two such examinations is not to exceed 36 months. An extension of examination of the unit's bottom of three months beyond the due date may be granted in exceptional circumstances (see [2.1.7]).

Note 1: Attention is drawn to the relevant requirements of Ch 1, Sec 1, [3.1], concerning application of national and international regulations.

5.4.4 Examinations of the outside of unit's bottom and related items of units are normally to be carried out with the unit in drydock. However, consideration may be given to alternate examination while the unit is afloat as an In-water Survey, subject to the provisions of Ch 3, Sec 6, [3]. Special consideration is to be given to units of 15 years or over before being permitted to have such examinations.

5.4.5 For units of unusual characteristics or engaged on special services, means of underwater inspection equivalent to the bottom survey in dry condition may be considered as an alternative by the Society, particularly when a suitable high resistance paint is applied to the underwater portion of the hull or an approved system of impressed current for external cathodic protection is fitted.

5.4.6 Compliance with the requirements of [5.4] and Ch 3, Sec 6 does not absolve the Owner from compliance with applicable international and national regulations,

especially when shorter intervals between examinations of the unit's bottom are required for certain types of units.

5.5 Survey of propulsion systems

5.5.1 Traditional propulsion system (1/7/2023)

For units fitted with traditional propulsion system (e.g main and auxiliary engines and turbines, electrical propulsion, tail shaft(s), reduction gears etc.), reference is to be made to the relevant requirements of the Rules for Classification of Ships. However, due to low number of running hours on tail shafts, alternative means apply to assure the condition of the propeller shaft assembly.

The following ascertainties are to be carried out as applicable:

- diver's external examination of stern bearing and outboard seal area, including wear down check as far as possible
- examination of the shaft area (inboard seals) in propulsion room(s)
- confirmation of lubricating oil records (satisfactory oil loss rate, no evidence of unacceptable contamination)
- examination/replacement of shaft seal elements in accordance with seal manufacturer's recommendations.

In case the owner of a floating unit fitted with propulsion system is planning to perform a voyage using its own propulsion system, he is to notify the Society and request, prior to sail, an occasional survey whose scope is evaluated based on the period of inactivity, taking in account the re-commissioning procedure foreseen in the Operating Manual.

5.5.2 Other propulsion systems (1/7/2023)

Driving components serving the same purpose as the tailshaft in other propulsion systems, such as directional propellers, vertical axis propellers, water jet units, dynamic positioning systems and thruster assisted mooring systems, are to be submitted to periodical surveys at intervals not exceeding five years.

5.6 Boiler survey

5.6.1 Water tube boilers used for main propulsion, including reheat boilers, all other boilers for essential service, and boilers for non-essential service having working pressure exceeding 0,35 N/mm² and a heating surface exceeding 4,5 m², are to be surveyed internally. There is to be a minimum of two internal examinations during each 5-year class renewal survey period. In all cases the interval between any two such examinations is not to exceed 36 months.

5.6.2 External survey of boilers including test of safety and protective devices and test of safety valves using their relieving gear, is to be carried out annually, within the window of the Annual Survey.

For exhaust gas heated economisers, the safety valves are to be tested by the Chief Engineer at sea within the annual survey window. This test is to be recorded in the log-book for review by the attending Surveyor prior to crediting the Annual Survey of Machinery.

5.6.3 An extension of the internal examination of the boiler up to 3 months beyond the due date can be granted in exceptional circumstances (see Note 1). The extension may be granted by the Society provided a survey is carried out in accordance with the provisions given in Ch 3, Sec 7, [1.1.6].

Note 1: "Exceptional circumstances" means, for example, unavailability of repair facilities, unavailability of essential materials, equipment or spare parts, or delays incurred by action taken to avoid severe weather conditions.

5.7 Links between anniversary dates and annual surveys, intermediate surveys and class renewal surveys

5.7.1 The link between the anniversary dates, the class renewal survey (when carried out according to the normal system), and the annual and intermediate surveys is given in Fig 1.

Figure 1 : Links between anniversary date and annual, intermediate and class renewal surveys

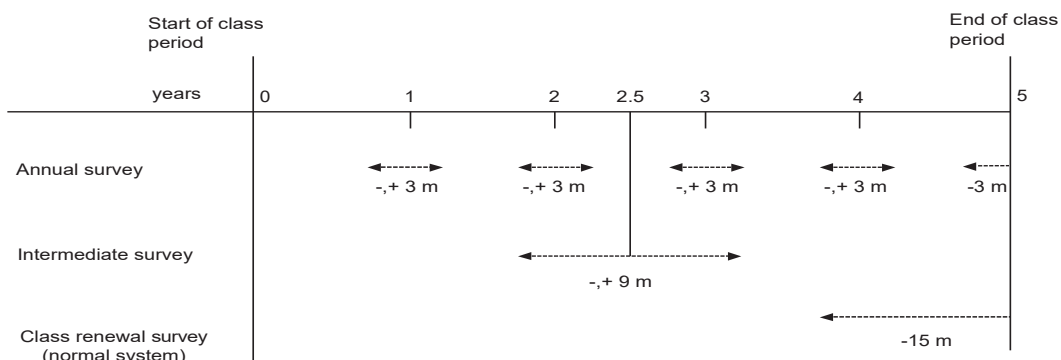

6 Occasional surveys

6.1 General

6.1.1 An occasional survey is any survey which is not a periodical survey. The survey may be defined as an occasional survey of hull, machinery, boilers, refrigerating plants, etc., depending on the part of the unit concerned.

Where defects are found, the Surveyor may extend the scope of the survey as deemed necessary.

6.1.2 Occasional surveys are carried out at the time of, for example:

- a) updating of classification documents (e.g. change of the Owner, name of the unit, flag)
- b) damage or suspected damage
- c) repair or renewal work
- d) alterations or conversion
- e) quality system audits
- f) postponement of surveys or recommendations.

6.2 Damage and repair surveys

6.2.1 In the event of damage which affects or may affect the class of the unit, the Owner is to apply to the Society for a survey. Such application is to be made as soon as possible to enable the Surveyor to ascertain the extent of the damage and necessary repairs, if any.

Note 1: Whenever a unit is fitted with a helicopter platform which is made in aluminium or other low melting metal construction which is not made equivalent to steel, and a fire occurred on the said platform or in close proximity, the platform is to be subject to a structural survey to determine its suitability for further use.

6.2.2 After sustaining damage the Owner is to notify the Society forthwith, supply all available information regarding the damage and make arrangements for the unit to be surveyed at the first convenient occasion.

6.2.3 All repairs to hull, machinery and equipment which may be required in order for a unit to retain its class are to be to the satisfaction of the Surveyor.

During repairs or maintenance work, the Owner is to arrange so that any damage, defects or non-compliance with the rule requirements are reported to the Surveyor during his survey.

6.2.4 Damages and partial or temporary repairs considered acceptable by the Surveyor for a limited period of time are the subject of an appropriate recommendation.

6.2.5 Damages or repairs required by the Surveyor to be re-examined after a certain period of time are the subject of an appropriate recommendation.

6.3 Conversions, alterations and repairs

6.3.1 Conversions, alterations or repairs of/to structures and arrangements affecting the class are to be carried out in accordance with the requirements of the Society and to its satisfaction. Where necessary, documentation is to be

submitted to the Society and/or made available to the attending Surveyor.

6.3.2 Materials and equipment used for conversions, alterations or repairs are generally to meet the requirements of the Rules for new units built under survey; see Sec 1, [2.1.5].

6.4 Quality System audits

6.4.1 The Society reserves the right to carry out occasional surveys in order to conduct audits either as deemed necessary in pursuance of its internal Quality System or as required by external organisations (e.g. IACS, flag Administrations).

6.4.2 These surveys may also be attended by auditors external to the Society.

6.4.3 The scope of these surveys is determined by the Society.

7 Change of ownership

7.1

7.1.1 In the case of change of ownership, the unit retains its current class with the Society provided that:

- a) the Society is informed of the change sufficiently in advance to carry out any survey deemed appropriate, and
- b) the new Owner signs the appropriate request, involving acceptance of the Society's general conditions and Rules.

This request covers inter alia the condition of the unit when changing ownership.

Note 1: The unit's class is maintained without prejudice to those provisions in the Rules which are to be enforced in cases likely to cause suspension or withdrawal of the class such as particular damages or repairs to the unit of which the Society has not been advised by the former or, as the case may be, new Owner.

Note 2: No information whatsoever related to the class of the unit will be provided or confirmed to any third party, unless the appropriate request for information is duly completed and signed by the party making the request and the authorisation of the current Owner is obtained.

8 Lay-up and re-commissioning

8.1 General principles

8.1.1 A unit put out of commission may be subject to specific requirements for maintenance of class, as specified below, provided that the Owner notifies the Society of the fact.

If the Owner does not notify the Society of the laying-up of the unit or does not implement the lay-up maintenance program, the unit's class will be suspended and/or withdrawn when the due surveys are not carried out by their limit dates in accordance with the applicable requirements given in Sec3.

8.1.2 The lay-up maintenance program provides for a "laying-up survey" to be performed at the beginning of lay-up and subsequent "annual lay-up condition surveys" to be performed in lieu of the normal annual surveys which are no longer required to be carried out as long as the unit remains laid-up. The minimum content of the lay-up maintenance program as well as the scope of these surveys are given in Ch 3, App 1. The other periodical surveys which become overdue during the lay-up period may be postponed until the re-commissioning of the unit.

8.1.3 Where the unit has an approved lay-up maintenance program and its period of class expires, the period of class is extended until it is re-commissioned, subject to the satisfactory completion of the annual lay-up condition surveys as described in [8.1.2].

8.1.4 The periodical surveys carried out during the lay-up period may be credited, either wholly or in part, at the discretion of the Society, having particular regard to their extent and dates. These surveys will be taken into account for the determination of the extent of surveys required for the re-commissioning of the unit and/or the expiry dates of the next periodical surveys of the same type.

8.1.5 When a unit is re-commissioned, the Owner is to notify the Society and make provisions for the unit to be submitted to the following surveys:

- a) an occasional survey prior to re-commissioning, the scope of which depends on the duration of the lay-up period
- b) all periodical surveys which have been postponed in accordance with [8.1.2], taking into account the provisions of [8.1.4].

8.1.6 Where the previous period of class expired before the re-commissioning and was extended as stated in [8.1.3], in addition to the provisions of [8.1.5] a complete class renewal survey is to be carried out prior to re-commissioning. Those items which have been surveyed in compliance with the class renewal survey requirements during the 15 months preceding the re-commissioning may be credited. A new period of class is assigned from the completion of this class renewal survey.

8.1.7 The principles of intervals or limit dates for surveys to be carried out during the lay-up period, as stated in [8.1.1] to [8.1.6], are summarised in Fig 2.

8.1.8 The scope of the laying-up survey and annual lay-up condition surveys are described in detail in Ch 3, App 1.

Note 1: A. C. S. means annual lay-up condition survey.

9 Possible safety management system failures

9.1

9.1.1 For self-propelled MODUs, when deficiencies relating to possible safety management system failures are identified by the Surveyor during a periodical (annual/intermediate/renewal) class survey or occasional class survey, statutory surveys, additional surveys relevant to flag State Inspections or any other occasion, a report is to be completed by the Surveyor so that the Organisation responsible for the issue of the SMC, if other than the Society, is notified.

Reporting and follow-up actions will be performed in accordance with the Society's procedures.

Figure 2 : Survey scheme of a case of a lay-up going beyond the expiry date of the period of class

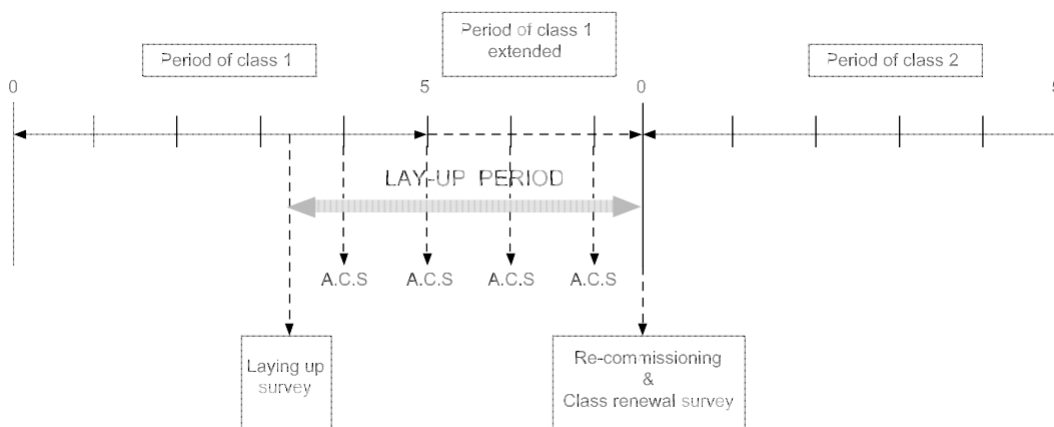

SECTION 3

SUSPENSION AND WITHDRAWAL OF CLASS

1 General

1.1 Discontinuance of class

1.1.1 The class may be discontinued either temporarily or permanently. In the former case it is referred to as "suspension" of class, in the latter case as "withdrawal" of class. In both these cases, the class is invalidated in all respects. In the case of withdrawal, a specific notation is entered in the supplement to the Register of Ships, until the unit is deleted from the Register.

1.2 Suspension of class

1.2.1 The class may be suspended either automatically or following the decision of the Society. In any event, the unit will be considered as not retaining its class from the date of suspension until the date when class is reinstated.

1.2.2 The class is automatically suspended when one or more of the following circumstances occur:

- a) when a unit is not operated in compliance with the rule requirements, such as in cases of services or conditions not covered by the service notation, or trade outside the navigation restrictions (for self-propelled MODUs) or the specified operating areas (for units other than self-propelled MODUs) for which the class was assigned, or
- b) when a self-propelled MODU proceeds to sea with less freeboard than that assigned, or has the freeboard marks placed on the sides in a position higher than that assigned, or, in cases of units where freeboards are not assigned, the draught is greater than that assigned
- c) when the Owner fails to inform the Society in order to submit the unit to a survey after defects or damages affecting the class have been detected
- d) when repairs, alterations or conversions affecting the class are carried out either without requesting the attendance of the Society or not to the satisfaction of the Surveyor. For voyage repairs, reference is to be made to Sec 2, [2.10]

Suspension of class with respect to the above cases will remain in effect until such time as the cause giving rise to suspension has been removed. Moreover, the Society may require any additional surveys deemed necessary taking into account the condition of the unit and the cause of the suspension.

1.2.3 Suspension and reinstatement of class in the case of overdue class renewal survey

Owners are to be notified that the 5-year Certificate of Classification expires and classification is automatically suspended from the certificate expiry date in the event that the class renewal survey has not been completed or is not under attendance for completion prior to resuming trading, by the due date.

Classification will be reinstated upon satisfactory completion of the surveys due. Such surveys are to be credited from the date originally due.

Under "exceptional circumstances", as defined in Sec 2, [2.1.7], the Society may grant an extension not exceeding three months to allow for completion of the class renewal survey provided that the unit is attended and the attending Surveyor(s) so recommend(s) after the following have been carried out:

- a) annual survey;
- b) re-examination of recommendations;
- c) progression of the class renewal survey as far as practicable.

In the case where bottom survey is due prior to the end of the class extension, an underwater examination is to be carried out by an approved diving company. An underwater examination by an approved company may be dispensed with in the case of an extension of the bottom survey not exceeding 36 months provided the unit is without outstanding recommendations regarding underwater parts.

In the case of a self-propelled MODU, if the Certificate of Classification will expire when the unit is expected to be at sea, an extension to allow for completion of the class renewal survey may be granted provided that there is documented agreement to such an extension prior to the expiry date of the certificate, that satisfactory arrangements have been made for attendance of the Surveyor at the first port of call, and that the Society is satisfied that there is technical justification for such an extension. Such an extension is to be granted only until arrival at the first port of call after the expiry date of the certificate. However, if owing to "exceptional circumstances" the class renewal survey cannot be completed at the first port of call, the procedure given above in the event of "exceptional circumstances" may be followed, but the total period of extension is in no case to be longer than three months after the original due date of the class renewal survey.

1.24 Suspension and reinstatement of class in the case of overdue intermediate survey

Owners are to be notified that the Certificate of Classification becomes invalid, and classification is automatically suspended, if the intermediate survey has not been completed within three (3) months of the due date of the third annual survey in each periodical survey cycle, unless the unit is under attendance for completion of the intermediate survey.

Classification will be reinstated upon satisfactory completion of the surveys due. Such surveys are to be credited from the date originally due.

1.25 Suspension and reinstatement of class in the case of overdue annual survey

Owners are to be notified that the Certificate of Classification becomes invalid, and classification is automatically suspended, if the annual survey has not been completed within three (3) months of the due date of the annual survey, unless the unit is under attendance for completion of the annual survey.

Classification will be reinstated upon satisfactory completion of the surveys due. Such surveys are to be credited from the date originally due.

1.26 Suspension of class in the case of overdue continuous survey item(s)

Continuous survey item(s) due or overdue at the time of the annual survey is (are) to be dealt with. The unit's class will be subject to a suspension procedure if the item(s) is (are) not surveyed, or postponed by agreement

1.27 Other cases of suspension of class

In addition to the circumstances for which automatic suspension may apply, the class of a unit may also be suspended following the decision of the Society:

- a) when one or more surveys are not held by their limit dates (see Sec 2, [2.1.4]) or the dates stipulated by the Society also taking into account any extensions granted in accordance with the provisions of Part A
- b) when, due to reported defects, the Society considers that a unit is not entitled to retain its class even on a temporary basis (pending necessary repairs or renewals, etc.)
- c) in other circumstances which the Society will consider on their merits (e.g. in the event of non-payment of fees or where the Owner fails to subject the unit to the occasional survey as per the requirement in Sec 2, [6.2.1]).

Suspension of class decided by the Society takes effect from the date when the conditions for suspension of class are met and will remain in effect until such time as the class is reinstated once the due items and/or surveys have been dealt with.

1.28 Laid-up units

Units laid-up in accordance with the requirements indicated in Sec 2, [8.1.1] prior to surveys becoming overdue need not be suspended when surveys addressed above become overdue. However, units which are laid-up after being suspended as a result of surveys going overdue, remain suspended until the overdue surveys are completed.

1.29 Voyage to demolition

When it is intended to take a unit on a demolition voyage with any periodical survey overdue, the unit's class suspension may be held in abeyance and consideration may be given to allowing the unit to proceed on a single direct ballast voyage from the lay-up or final operation location to the demolition yard. In such cases a short-term Certificate of Classification with conditions for the voyage noted may be issued provided the attending Surveyor finds the unit in satisfactory condition to proceed on the intended voyage.

1.210 Force Majeure

In the case of self-propelled MODUs, if, due to circumstances beyond the Owner's or the Society's control, as defined in Sec 2, [2.1.8], the unit is not in a location where the overdue surveys can be completed at the expiry of the periods allowed above, the Society may allow the unit to sail, in class, directly to an agreed location, and if necessary, from there, in ballast, to an agreed destination at which the survey will be completed, provided the Society:

- a) examines the unit's records;
- b) carries out the due and/or overdue surveys and examination of recommendations at the first possible location when there is unforeseen inability of the Society to attend the unit in the present location, and
- c) has satisfied itself that the unit is in condition to sail for one trip to first location and subsequent ballast voyage to a repair facility if necessary. (Where there is unforeseen inability of the Society to attend the unit in the present location, the Master is to confirm that his unit is in condition to sail to the nearest location.)

If class has already been automatically suspended in such cases, it may be reinstated subject to the conditions prescribed in this item.

1.211 Single voyage for repair of laid-up units (1/7/2013)

When a unit is intended for a single voyage from laid-up position to repair yard with any periodical survey overdue, the unit's class suspension may be held in abeyance and consideration may be given to allow the unit to proceed on a single direct ballast voyage from the site of lay up to the repair yard, upon agreement with the Flag Administration, provided the Society finds the unit in satisfactory condition after surveys, the extent of which are to be based on surveys overdue and duration of lay-up. A short term Class Certificate with conditions for the intended voyage may be issued. This is not applicable to units whose class was already suspended prior to being laid-up.

1.212 Suspension and reinstatement of class in the case of overdue recommendations

Each recommendation will be assigned a due date for completion. Owners will be notified of these dates and that the unit's class will be subject to a suspension procedure if the item is not dealt with, or postponed by agreement, by the due date.

Classification will be reinstated upon verification that the overdue recommendation has been satisfactorily dealt with.

1.3 Withdrawal of class

1.3.1

The Society will withdraw the class of a unit in the following cases:

- a) at the request of the Owner
- b) when the causes that have given rise to a suspension currently in effect have not been removed within six months of the date of suspension. However, the Society may withdraw the class of the unit before the end of the six-month period where it deems it appropriate. A longer suspension may be granted at the Society's discretion when the unit is not trading as in cases of lay-up, awaiting disposition in the case of a casualty or attendance for reinstatement
- c) when the unit is reported as a constructive total loss
- d) when the unit is lost
- e) when the unit is reported scrapped.

Withdrawal of class takes effect from the date on which the circumstances causing such withdrawal occur.

1.3.2 When the withdrawal of class of a unit comes into effect, the Society will:

- a) forward the Owner written notice
- b) delete the unit from the Register of Ships
- c) notify the flag Administration
- d) make the information available to the Underwriters, at their request.

1.4 Reassignment of class following class withdrawal

1.4.1 (1/7/2015)

At the request of the Owner, a unit which was previously classed with the Society, subsequently withdrawn from class and that has not been further classed i.e.

- has never resumed its trade
- has not been classified by any other Classification Society

may have the class reassigned.

1.4.2 (1/7/2015)

The reassignment of Class may take place upon satisfactory:

- removal of the causes that led to class withdrawal
- execution of the surveys expired during the period of class withdrawal.

verification of additional ascertainties as deemed necessary by the Society according to the provisions of Ch 3, Sec 2, [4.1].

The new period of Class and the validity of the Certificate of Classification will be considered by the Society on a case by case basis.

1.5 Suspension/withdrawal of additional class notations

1.5.1 If the survey requirements related to maintenance of additional class notations are not complied with, the suspension or withdrawal may be limited to the notations concerned.

The same procedure may apply to service notations of units which are assigned with more than one service notation.

1.5.2 The suspension or withdrawal of an additional class notation or a service notation (where a unit is assigned with more than one service notation) generally does not affect the class.

APPENDIX 1

CMS AND PMS: SURVEYS CARRIED OUT BY THE CHIEF ENGINEER

1 Documentation

1.1

1.1.1 The basic conditions for the acknowledgment of surveys carried out by Chief Engineers are specified hereafter. Consideration may be given to other conditions on a case by case basis.

1.1.2 (1/1/2016)

The Company is responsible for ensuring that the Chief Engineer is qualified to register and carry out maintenance on all class-related items.

1.1.3 (1/1/2016)

The Chief Engineer must be a permanent employee of the Company. He must have been working in this position for a reasonable period of time or have possessed the recognition of the Society for another Company by which he was employed.

He is to hold a certificate of competency as provided by STCW 95 Convention for the power of the main propulsive installation of the unit. He is to have at least three years of seagoing experience as Senior Engineer Officer on units of the type (motor or steam unit) for which he will be qualified.

1.1.4 (1/1/2016)

The Owner is to keep the Society informed about any changes concerning the Chief Engineers employed with his Company due to resignations, alternations, etc.

1.1.5 (1/1/2016)

The Owner is also to provide the Chief Engineer with a copy of this Appendix, enabling him to familiarise himself with the conditions, scope and limits of his interventions.

The authorisation ceases to be valid when the Chief Engineer leaves the Company.

2 Limits of the interventions

2.1

2.1.1 (1/7/2023)

For units where the CMS is implemented, the following items of the class renewal survey for machinery cannot be inspected by the Chief Engineer:

- pressure vessels (except class 2 and 3 heat exchangers)
- main and auxiliary turbines, as applicable
- main reduction gears
- crankshafts, with associated main bearings and bottom end connecting rod bearings, of main propulsion internal combustion engines. However, bottom end connecting rod bearings of diesel engines having trunk

pistons may be inspected by the Chief Engineer when the complete associated cylinder is inspected in the course of the engine maintenance program

- turbochargers of main propulsion internal combustion engines
- intermediate shafting and associated bearings
- steering gear system, including pumps.

Generally, within a 10-year cycle comprising two consecutive class cycles, all the items surveyed under CMS are to be inspected once by the Society's Surveyors.

The attention of Chief Engineers is drawn to the fact that surveys performed by them in locations which are under the jurisdiction of an office of the Society or during very short voyages between ports where Surveyors of the Society are available will not be credited.

2.1.2 (1/7/2023)

For units where the PMS is implemented the items listed in [2.1.1] cannot be surveyed by the Chief Engineer.

Where a Planned Maintenance Scheme approved by the Society is implemented and Condition Based Maintenance complying with the requirements of Pt F, Ch 1 is applied, the following items can be surveyed by the Chief Engineer, on condition that they are subjected to the Condition Based Maintenance (CBM) program:

- main and auxiliary turbines, as applicable,
- crankshafts with associated main bearings and bottom end connecting rod bearings, of main propulsion internal combustion engines,
- turbochargers of main propulsion internal combustion engines,
- intermediate shafting and associated bearings.

Moreover, in such case the confirmatory survey is to include the checks indicated in [5.1.4].

In no case may the surveys of the following items be carried out by the Chief Engineer:

- pressure vessels (except class 2 and 3 heat exchangers)
- main reduction gears
- steering gear system, including pumps.

2.1.3 In no case may the surveys of tailshafts and boilers, which are items not included in the scope of the class renewal survey, be carried out by the Chief Engineer.

3 Procedure for carrying out surveys

3.1 General

3.1.1 As regards the procedure for carrying out surveys, the Owner is to inform the Chief Engineer that surveys are

to be conducted in accordance with the Rules of the Society and, specifically, the requirements for class renewal surveys related to machinery and systems contained in Ch 3, Sec 5, [3].

It is the responsibility of the unit's Captain and Chief Engineer to decide the date and place for the survey of each component in order to avoid possible accidents (fire included) in the event of damage to the unit(s) remaining in service

Some guidelines for the Chief Engineer relevant to the dismantling and inspections of main components of the machinery installation are given below.

The items and/or machinery which, as a result of the surveys, are replaced due to wear, damage or defects, are to be kept on board until they are inspected by a Surveyor of the Society.

3.2 Main diesel engines

3.2.1 (1/7/2023)

The following items are to be surveyed as indicated:

- a) the top and bottom halves of the main bearings are to be removed and inspected, and the clearances are to be taken, recorded and compared with the limits recommended by the engine builder
- b) the top and bottom halves of crankpin bearings are to be examined, and the clearances are to be taken, recorded and compared with the limits recommended by the engine builder
- c) crankpins, journals and webs are to be examined for crack detection, mainly at the fillets and in the vicinity of the lubricating oil holes
- d) crankshaft deflections are to be taken and recorded at regular intervals, enabling verification of the trend when they are taken in the presence of the Society's Surveyor. This operation is to be effected bearing in mind that during the readings the journals are to be steady on their bearings
- e) other parts exposed to wear or operating incidents are to be carefully examined and the results recorded. In particular, the wear of liners is to be measured and recorded.

3.3 Auxiliary diesel engines

3.3.1 The survey generally consists in the complete dismantling of the engine and a careful examination of those items most liable to be exposed to wear or operating incidents. In particular:

- a) crankshaft deflections and wear of cylinder liners are to be measured
- b) the crankshaft is to be checked by means of dye penetrant in way of fillets and lubricating oil holes
- c) all top halves of the main bearings together with at least two bottom halves are to be dismantled
- d) crankcase explosion relief valves, if fitted, are to be checked.

3.4 Reciprocating compressors

3.4.1 The survey is to include:

- a) the dismantling of pistons and valves for inspection
- b) the examination and testing of the nest of cooler tubes
- c) the verification of safety relief valves after reassembling.

3.5 Coolers, condensers, heaters

3.5.1 The survey is to include:

- a) the dismantling of the covers
- b) the examination of the nest of tubes
- c) the testing of the nest of tubes, if necessary.

3.6 Electrical switchboard

3.6.1 The survey is to include:

- a) the cleaning of the switchboard
- b) the verification of the connection assemblies, locking device tightening and busbar tightening
- c) the examination of the condition of the circuit-breakers, switches and fuses
- d) the verification of the contacts and screens
- e) the checking of the measuring instruments, which are to be re-calibrated or replaced, if inaccurate
- f) the megger test.

3.7 a.c. and d.c. generators

3.7.1 The survey is to include:

- a) the removal of protection plates and brush carriers
- b) the cleaning of field coils and armature windings
- c) the verification of proper contact of brushes, which are to be renewed if excessively worn
- d) the verification of commutators and sliprings
- e) the measurement of air gap clearances
- f) the checking of journals and bearings
- g) the megger test.

3.8 Other items (pumps, electric motors, etc.)

3.8.1 The survey is generally to include the complete dismantling for inspection of the main parts exposed to wear or operating incidents, such as bearings, casings, impellers and rotors.

4 Records of surveys carried out

4.1

4.1.1 The surveys carried out by the Chief Engineer are to be recorded in the engine/machinery log-book and a survey report is to be prepared for each item surveyed.

The report is generally to be drawn up in English; however, for units trading in specific restricted areas the use of the language of the country concerned will be accepted.

The report may be provided in hard copy or using a computerised recording system.

4.1.2 The report is to indicate the following information:

- a) identification data:
 - name of unit and register number
 - name of Chief Engineer and reference of the Society's authorisation
 - date and place (port or voyage leg) of the survey
 - reference of the item in the CMS or PMS list, and description of the item.
- b) inspection conducted:
 - the type of inspection carried out: visual external examination, internal examination after dismantling, overhaul
 - readings performed, when applicable: clearances, measurements, working pressure, or other working parameters of the equipment
 - inspection findings: corrosion, fractures, pieces of equipment worn out, broken or missing
- c) maintenance and repairs carried out and parts replaced
- d) results of tests performed after the inspection, such as working test, pressure test.

For sake of completeness, other documentation such as sketches, photos, measurement reports may be attached to the report.

The report is to be signed by the Chief Engineer.

5 Confirmatory survey

5.1

5.1.1 A confirmatory survey, to be carried out by a Surveyor of the Society, is to be requested according to the following principle:

- a) for units under the CMS, within a reasonably short time from the date of the surveys carried out by the Chief

Engineer, and, in any case, in the first port which is under the jurisdiction of an Office of the Society

- b) for units under the PMS, at the next annual audit (see Part F, Chapter 1).

5.1.2 The Surveyor is to be supplied with a copy of this survey report and also shown the engine log-book.

5.1.3 The Surveyor carries out an external examination of the relevant items and parts replaced and, if applicable, attends running tests. If doubts arise, the Surveyor may request dismantling as deemed necessary.

5.1.4 (1/7/2023)

If the persons on board are authorised to survey the main engine crankshaft and bearings (see [2.1.2]), the Surveyor performs the following:

- a) check of condition monitoring records
- b) check of crankshaft deflection readings
- c) check of bearing clearances (where possible)
- d) checks for signs of wiped or broken white metal in the crankcase or filter
- e) check of the witness marks of shrink fits of crankshafts
- f) check of the bedplate structure (inside and outside)
- g) check that the condition of crankpins, journals and associated bearings is duly recorded.

5.1.5 Where the confirmatory survey is performed with an abnormal delay, the inspection is to be more extensive and, if necessary, the due surveys are to be completely repeated.

5.1.6 The date of the execution of the surveys will be assumed to be the date of the confirmatory survey.

6 Suspension of the Chief Engineer's authorisation

6.1

6.1.1 Where the condition of the items surveyed by the Chief Engineer as specified in his reports does not correspond to the findings of the attending Surveyor, the Society may suspend the validity of the Chief Engineer's authorisation.

APPENDIX 2

THICKNESS MEASUREMENTS: EXTENT, DETERMINATION OF LOCATIONS AND ACCEPTANCE CRITERIA

1 General

1.1 Aim of the Appendix

1.1.1 Thickness measurements are a major part of surveys to be carried out for the maintenance of class, and the analysis of these measurements is a prominent factor in the determination and extent of the repairs and renewals of the unit's structure.

1.1.2 The Appendix is intended to provide Owners, companies performing thickness measurements and the Society's Surveyors with a uniform means with a view to fulfilling Rule requirements for thickness measurements. In particular, it will enable all the above-mentioned parties to carry out:

- a) the planning and preparation
- b) the determination of extent and location, and
- c) the analysis of the thickness measurements in cooperation.

1.2 Scope of the Appendix

1.2.1 Separate Articles below provide the following information:

- a) references to rule requirements and some additional information on the extent of the thickness measurements to be performed during surveys according to types of units and related surveys (see [2])
- b) locations of the measurements for the main parts of the unit (see [3])
- c) how to analyse the results of thickness measurements (see [4]).

Tables and sketches are also given to detail the above points according to the types of units.

2 Rule requirements for the extent of measurements

2.1 General

2.1.1 For the maintenance of class, thickness measurements may be required during annual, intermediate and class renewal surveys.

Tab 1 gives the references to the requirements for minimum thickness measurements indicated in Chapter 3 and Chapter 4 for each service notation and related to the different types of surveys.

Some additional explanations are also given about the wording used in the Rules as well as the general principles of the required thickness measurements during class renewal surveys.

2.2 Class renewal survey for all units

2.2.1 The thickness measurements required by the Rules consist of:

- a) systematic thickness measurements, i.e. measurements of different parts of the structure in order to assess the overall and local strength of the unit
- b) measurements of suspect areas as defined in Sec 2, [2.2.8]
- c) additional measurements on areas determined as affected by substantial corrosion as defined in Sec 2, [2.2.7].

3 Number and locations of measurements

3.1 General

3.1.1 Considering the extent of thickness measurements as required by the Rules and indicated in [2] above, the locations of the points to be measured are given here for the most important items of the structure. Thus the number of points can be estimated.

3.2 Locations of points

3.2.1 Tab 2 provides explanations and/or interpretations for the application of those requirements indicated in the Rules which refer to both systematic thickness measurements related to the calculation of global hull girder strength and specific measurements connected to close-up surveys.

Figures are also given to facilitate the explanations and/or interpretations given in the table. These figures show typical arrangements of FSOs / FPSOs. Due to the various designs of unit types, especially for MODUs, figures do not cover all the different cases. However, the figures provided here may be used as guidance for units other than those illustrated.

4 Acceptance criteria for thickness measurements

4.1 General

4.1.1 (1/7/2015)

Acceptance criteria stipulate limits of wastage which are to be taken into account for reinforcements, repairs or renewals of steel structure. These limits are generally expressed for each structural item as a maximum percentage of acceptable wastage (W). When the maximum percentage of

wastage is indicated, the minimum acceptable thickness (t_{\min}) is that resulting from applying this percentage to the rule thickness (t_{rule}), according to the following formula:

$$t_{\min} = \left(1 - \frac{W}{100}\right) t_{\text{rule}}$$

However, when the rule thickness is not available, the as-built thickness can be used.

Only for criteria related to an item (see [4.3.4] b), the Society may establish a list of renewal thicknesses tailored to the different structural items. In such a case these thicknesses are used in lieu of the minimum thicknesses calculated from the percentage of wastage.

For units assigned with the additional class notation CSR, acceptance criteria given in the "Common Structural Rules for Bulk Carriers and Oil Tankers" are used.

Table 1 : References to Rule requirements related to thickness measurements

SERVICE NOTATION	TYPE OF SURVEY		
	CLASS RENEWAL	INTERMEDIATE	ANNUAL
MODU	Ch 3, Sec 5, [2.5] and Ch 3, Sec 5, Tab 2: systematic measurements and suspect areas Where substantial corrosion is found, the extent of thickness measurements may be increased to the Surveyor's satisfaction, using Ch 3, Sec 5, Tab 3 as guidance	Ch 3, Sec 4, [2.1] : thickness measurements to be taken if deemed necessary by the Surveyor Where substantial corrosion is found, the extent of thickness measurements may be increased to the Surveyor's satisfaction, using Ch 3, Sec 5, Tab 3 as guidance	Ch 3, Sec 3, [3.3.1]: areas of substantial corrosion identified at previous surveys Where substantial corrosion is found, the extent of thickness measurements may be increased to the Surveyor's satisfaction, using Ch 3, Sec 5, Tab 3 as guidance
FSO	Ch 4, Sec 2, [6.1] and Ch 4, Sec 2, [6.4]: planned survey program and general requirements Ch 4, Sec 2, Tab 1 or Tab 2: measurements of elements subjected to close-up survey for single or double hull FSO units Ch 4, Sec 2, Tab 3 or Tab 4: extent of systematic thickness measurements for single or double hull FSO units Ch 4, Sec 2, Tab 5 to Tab 8 for single hull FSO units or Ch 4, Sec 2, Tab 9 to Tab 13 for double hull FSO units, according to the different locations, where substantial corrosion is found	Ch 4, Sec 2, [4] for both cargo and ballast tanks Ch 4, Sec 2, Tab 5 to Tab 8 for single hull FSO units or Ch 4, Sec 2, Tab 9 to Tab 13 for double hull FSO units, according to the different locations, where substantial corrosion is found	Ch 4, Sec 2, [2.3.1] limited to ballast tanks and when deemed necessary by the Surveyor Ch 4, Sec 2, Tab 5 to Tab 8 for single hull FSO units or Ch 4, Sec 2, Tab 9 to Tab 13 for double hull FSO units, according to the different locations, where substantial corrosion is found
FPSO	Ch 4, Sec 3, [7.1] and Ch 4, Sec 3, [7.4]: planned survey program and general requirements Ch 4, Sec 3, Tab 1 or Tab 2: measurements of elements subjected to close-up survey for single or double hull FPSO units Ch 4, Sec 3, Tab 3 or Tab 4: extent of systematic thickness measurements for single or double hull FPSO units Ch 4, Sec 3, Tab 5 to Tab 8 for single hull FPSO units or Ch 4, Sec 3, Tab 9 to Tab 13 for double hull FPSO units, according to the different locations, where substantial corrosion is found	Ch 4, Sec 3, [5] for both cargo and ballast tanks Ch 4, Sec 3, Tab 5 to Tab 8 for single hull FPSO units or Ch 4, Sec 3, Tab 9 to Tab 13 for double hull FPSO units, according to the different locations, where substantial corrosion is found	Ch 4, Sec 3, [2.3.1] limited to ballast tanks and when deemed necessary by the Surveyor Ch 4, Sec 3, Tab 5 to Tab 8 for single hull FPSO units or Ch 4, Sec 3, Tab 9 to Tab 13 for double hull FPSO units, according to the different locations, where substantial corrosion is found
FSRU	Ch 4, Sec 4, [6.1] : planned survey program and general requirements Ch 4, Sec 4, Tab 2 : measurements of elements subjected to close-up survey Ch 4, Sec 4, Tab 3 : extent of systematic thickness measurements	Ch 4, Sec 4, Tab 1 : thickness measurements to be taken if deemed necessary by the Surveyor	Ch 4, Sec 4, [2.1.6] and limited to salt ballast tanks and when deemed necessary by the Surveyor

Table 2 : Interpretations of rule requirements for the locations and number of points to be measured

A) SYSTEMATIC MEASUREMENTS		
ITEM	INTERPRETATION	FIGURE
Selected plates on deck, tank top, bottom, double bottom and wind-and-water	"Selected" means at least a single point on one out of three plates, to be chosen on representative areas of average corrosion	No figure
All deck, tank top and bottom plates and wind-and-water strakes	At least two points on each plate to be taken either at each 1/4 extremity of plate or at representative areas of average corrosion	No figure
Transverse section	Refer to the definition given in Sec 2, [2.2.5]	Fig 1 for FPSOs/FSOs
Selected internal structure such as floors and longitudinals, transverse frames, web frames, deck beams, 'tweendecks, girders	The internal structural items to be measured in each space internally surveyed are to be at least 20% within the cargo area and 10% outside the cargo area	No figure
Transverse section of deck plating outside line of cargo hatch openings (for units fitted with hatchways and coamings)	Two single points on each deck plate (to be taken either at each 1/4 extremity of plate or at representative areas of average corrosion) between the sides and hatch coamings in the transverse section concerned	
One section of deck plating for the full beam of the unit within the cargo area (for FSOs and FPSOs)	Two single points on each deck plate (to be taken either at each 1/4 extremity of plate or at representative areas of average corrosion) in the transverse section concerned	Fig 4 for FPSOs/FSOs

B) CLOSE-UP SURVEYS AND RELATED MEASUREMENTS (for FSOs, FPSOs and FSRUs)		
ITEM	INTERPRETATION	FIGURE
Web frame ring (for FSOs and FPSOs)	Refer to the definitions given in Ch 4, Sec 2, Tab 1 or Tab 2 for single or double hull FSO units and Ch 4, Sec 3, Tab 1 or Tab 2 for single or double hull FPSO units. "Adjacent structural members" means plating and stiffeners of deck, bottom, double bottom, sides and longitudinal bulkheads in the vicinity of the web frame ring	Extent of areas is shown as (1) in Fig 1 of Ch 4, Sec 2 or Sec 3 for single hull FSO or FPSO units and Fig 2 of Ch 4, Sec 2 or Sec 3 for double hull FSO or FPSO units Locations of points are given in Fig 5 for single hull units
Transverse section (for FSRUs)	Refer to the definitions given in Ch 4, Sec 4, Tab 2. "Adjacent structural members" means plating and stiffeners of deck, bottom, double bottom, sides and longitudinal bulkheads in the vicinity of the web frame ring	No figure
Deck transverse	This is the upper part of the web frame ring including the adjacent structural members (see meaning given above)	Extent of areas is shown as (2) Fig 1 of Ch 4, Sec 2 or Sec 3 for single hull FSO or FPSO units and Fig 2 of Ch 4, Sec 2 or Sec 3 for double hull FSO or FPSO units Locations of points are given in Fig 5 for single hull units
Deck and bottom transverses (for FSOs and FPSOs)	Refer to the definitions given in Ch 4, Sec 2, Tab 1 and Ch 4, Sec 3, Tab 1 for single hull FSO and FPSO units respectively.	Extent of areas is shown as (2) and (5) in Fig 1 of Ch 4, Sec 2 for single hull FSO and FPSO units respectively Locations of points are given in Fig 5 for single hull units

B) CLOSE-UP SURVEYS AND RELATED MEASUREMENTS (for FSOs, FPSOs and FSRUs)		
ITEM	INTERPRETATION	FIGURE
Transverse bulkhead	"Complete" means the whole bulkhead including stringers and stiffeners and adjacent structural members as defined above	Extent of areas is shown as (3) in Fig 1 of Ch 4, Sec 2 or Sec 3 for single hull FSO or FPSO units and Fig 2 of Ch 4, Sec 2 or Sec 3 for double hull FSO or FPSO units Locations of points are given in Fig 5 for single hull units
	"Lower part" means lower part of bulkhead up to 1/4 of unit's depth or 2 metres above the lower stringer, whichever is the greater (stringers, stiffeners and adjacent structural members included)	Extent of areas is shown as (4) in Fig 1 of Ch 4, Sec 2 or Sec 3 for single hull FSO or FPSO units and as (5) in Fig 2 of Ch 4, Sec 2 or Sec 3 for double hull FSO or FPSO units Locations of points are given in Fig 5 for single hull units

Figure 1 : Transverse section of a FPSO / FSO

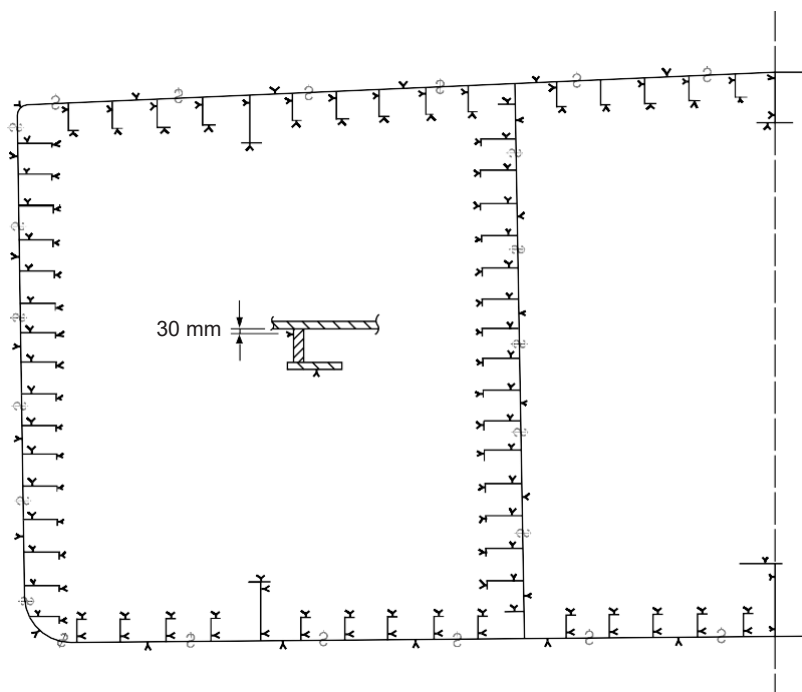

Measurements are to be taken on both port and starboard sides of the selected transverse section

Figure 2 : Locations of measurements on web frame rings and longitudinal elements of FPSOs / FSOs

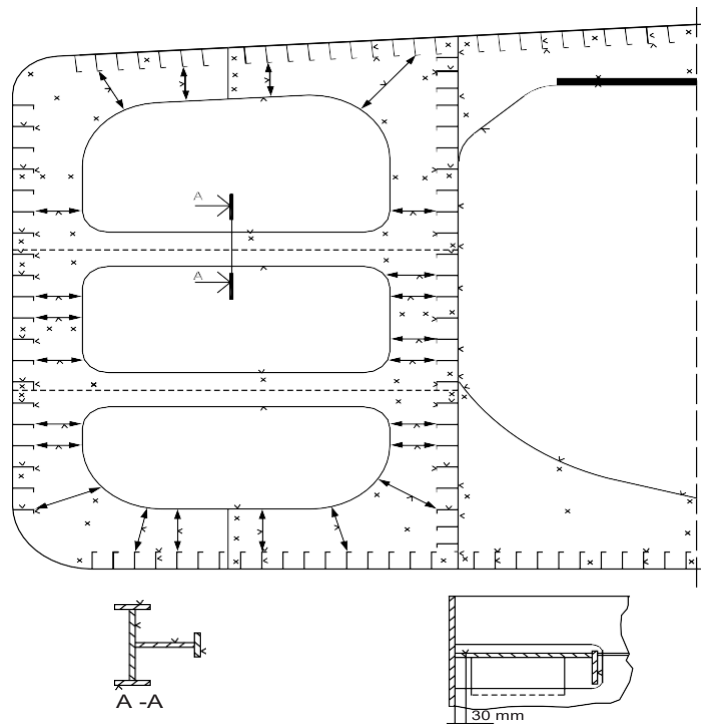
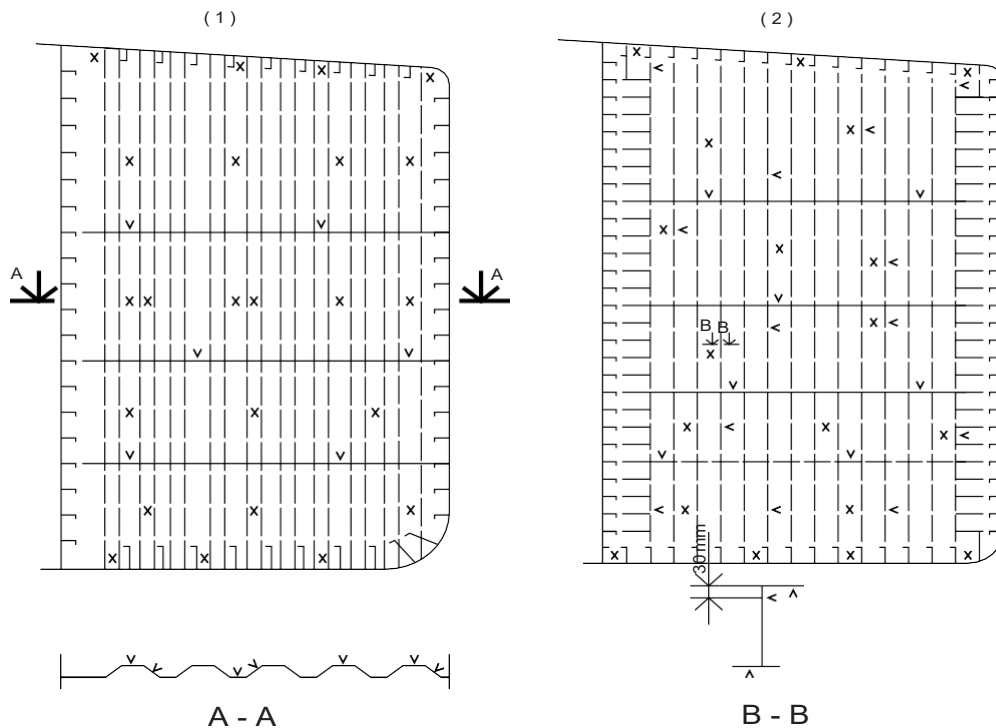

Figure 3 : Locations of measurements on transverse bulkheads of FPSOs / FSOs



(1) : Corrugated bulkhead

(2) : Plane bulkhead

Measurements are to be taken in a similar way on the centre tank bulkheads

Measurements are to cover the different thicknesses of strakes over the height of the bulkhead

Measurements are to be taken of the adjacent structural members

412 In cases where the unit has some structural elements with reduced wear margins (e.g. due to unit conversion, increase of draught), the minimum acceptable thickness for these elements is to be calculated with reference to the rule scantlings without taking account of any reduction originally agreed.

413 Decisions on steel renewals are taken by the attending Surveyor applying the criteria given in this Article and based on his judgment and the actual condition of the unit. Should advice be needed to support his decision, the Surveyor may refer to the relevant technical office of the Society.

4.2 Criteria

421 The acceptance criteria for the minimum thicknesses are divided into:

- criteria on local and global strength, given in [4.3]
- criteria on buckling strength, given in [4.4]
- criteria on pitting, given in [4.5].

422 Each measured structural item is to be checked against the following criteria, as far as applicable. Where any of the criteria are not met, reinforcements, repairs and renewals are to be carried out as appropriate.

4.3 Local and global strength criteria

431 Local and global strength criteria are given for the following unit types:

- MODUs
- FSRUs
- FPSOs and FSOs.

432 For the evaluation of the longitudinal strength of the unit, it is a prerequisite that fillet welding between longitu-

dinal members and deck, side and bottom plating is maintained effective so as to keep continuity of hull structures.

433 Each structural item to be assessed is illustrated in a typical transverse section (see Fig 6 for FPSOs / FSOs).

These structural items are also listed in appropriate tables grouped according to their position and contribution to the local or global strength of the unit.

434 Each structural item is to be assessed according to four different criteria which vary with regard to the domain under which it is considered, namely:

- a) an isolated area, which is meant as a part of a single structural item. This criterion takes into consideration very local aspects such as grooving of a plate or web, or local severe corrosion; however, it is not to be used for pitting for which separate criteria are considered (see [4.5])
- b) an item, which is meant as an individual element such as a plate, a stiffener, a web, etc. This criterion takes into consideration the average condition of the item, which is assessed by determining its average thickness using the various measurements taken on the same item
- c) a group of items, which is meant as a set of elements of the same nature (plates, longitudinals, girders) contributing either to the longitudinal global strength of the unit in a given zone or to the global strength of other primary transverse elements not contributing to the unit longitudinal strength, e. g. bulkheads, web frames
- d) a zone, which is meant as all and only longitudinal elements contributing to the longitudinal strength of the unit; in this regard, the three main zones are defined as deck zone, neutral axis zone and bottom zone. This criterion takes into consideration the average condition of all groups of items belonging to the same zone.

Table 3 : Buckling strength criterion

L > 120 m

ITEMS		RATIO	MATERIAL (R _{eH})		
			235	315	355 and 390
Bottom and deck plates		s / t	56,0	51,0	49,0
Longitudinals	flat bar web	h _w / t _w	20,0	18,0	17,5
Flanged longitudinals / girders	web	h _w / t _w	56,0	51,0	49,0
Flanged longitudinals / girders	symmetrical flange	b _f / t _f	34,0	30,0	29,0
Flanged longitudinals / girders	asymmetrical flange	b _f / t _f	17,0	15,0	14,5
Symbols: R _{eH} : minimum yield stress of the material, in N/mm ² ; h _w : web height, in mm; t _w : web thickness, in mm; s : longitudinal spacing, in mm; b _f : flange breadth, in mm; t : actual plate thickness, in mm; t _f : flange thickness, in mm;					

435 The assessment of the thickness measurements is to be performed using the values given in the tables for each structural element with regard to the criteria defined above, in the following order:

- a) assessment of isolated areas (column 1 in all three tables). If the criterion is not met, the wasted part of the item is to be dealt with as necessary.
- b) assessment of items (column 2 in all three tables). If the criterion is not met, the item is to be dealt with as necessary in the measured areas as far as the average condition of the item concerned is satisfactory. In cases where some items are renewed, the average thicknesses of these items to be considered in the next step are the new thicknesses.

Example: to report the average value for each aft/forward deck plate, the criteria given in [4.3.5] b) are to be met. Some isolated areas may be accepted according to the criteria given in [4.3.5] a).

- c) assessment of groups of items (column 3 in all three tables). If the criterion is not met, a sufficient number of elements are to be renewed in order to obtain an increased average thickness satisfying the considered criterion of the group (generally the elements to be renewed are those most wasted). As an example, for the assessment of the group "deck plates" all deck plates are measured and an average thickness of each of them is estimated. Then the average of all these values is to satisfy the criteria given for this group.
- d) assessment of zones (column 4 in all three tables). In principle, the criterion of the zone is met when all groups of items belonging to the zone meet their own criteria (see c) above). However, a greater diminution than those given in column 3 may be accepted for one group of items if, considering the other groups of items belonging to the same zone, the overall diminution of the zone does not exceed the criterion given for it in column 4.

Example: The deck zone consists of two groups of items:

- 1) deck plating, which has an average diminution of 12% (criterion 10%)
- 2) deck longitudinals, which has an average diminution of 4% (criterion 10%)

Even though the deck plating group exceeds its acceptance criterion, the average diminution of the zone, which can be very roughly estimated at 8%, is acceptable and thus the deck plating group can be accepted as it is.

The hull girder strength assessment is to be performed in accordance with the criteria specified in App 3.

436 These criteria take into consideration two main aspects:

- a) the overall strength of the hull girder
- b) the local strength and integrity of the hull structure, such as hatch covers, bulkheads, etc.

As a rule, they are applicable to the structure within the cargo area of units having a length greater than 90 metres. However, they may also be used for smaller units and for

structure outside the cargo area according to the following principles:

- a) for units having a length less than 90 metres, the percentages of acceptable wastage given in the tables can be increased by 5 (%) (e.g. 15% instead of 10%, etc.), except for those of deck and bottom zones
- b) or structure outside the cargo area, the same 5 (%) increase can be applied

on the understanding, however, that both conditions cannot be applied at the same time.

4.4 Buckling strength criterion

441 This criterion is applicable to units having a length greater than 120 metres.

In addition to the evaluation of structural elements according to [4.3] above, the structural items contributing to the longitudinal strength of the unit, such as deck and bottom plating, deck and bottom girders, etc., are also to be assessed with regard to their buckling strength. The values shown in Tab 3 are not to be exceeded.

Note 1: The minimum thickness will be specially considered for units built with excess hull girder section modulus.

4.5 Pitting

451 The maximum acceptable depth for isolated pits is 35% of the as-built thickness.

452 For areas with different pitting intensity, the intensity diagrams shown in Fig 4 are to be used to identify the percentage of affected areas.

For areas having a pitting intensity of 50% or more, the maximum acceptable average depth of pits is 20% of the as-built thickness. For intermediate values between isolated pits and 50% of affected area, the interpolation between 35% and 20% is made according to Tab 4.

Table 4 : Pitting intensity and corresponding maximum acceptable average depth of pitting

PITTING INTENSITY (%)	MAXIMUM ACCEPTABLE AVERAGE PITTING DEPTH (% of the as-built thickness)
Isolated	35,0
5	33,5
10	32,0
15	30,5
20	29,0
25	27,5
30	26,0
40	23,0
50	20,0

453 In addition, the thickness outside the pits in the area considered is to be assessed according to [4.3] and [4.4] above.

Note 1: Application of filler material (plastic or epoxy compounds) is recommended as a means to stop or reduce the corrosion pro-

cess, but it is not considered an acceptable repair for pitting exceeding the maximum allowable wastage limits. Welding repairs may be accepted when performed in accordance with procedures agreed with the Society.

Figure 4 : Pitting intensity diagrams (from 1% to 50% intensity)

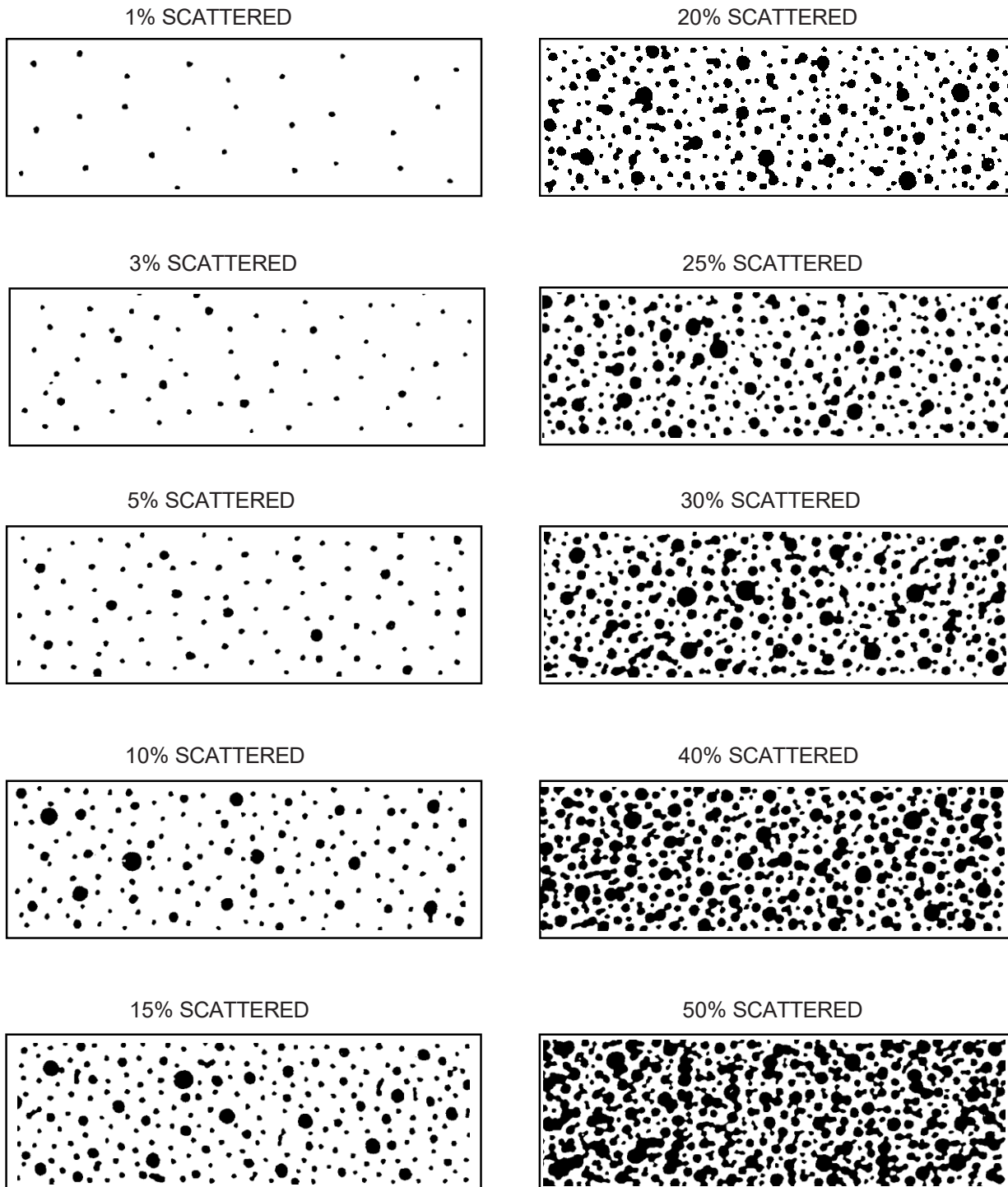

Table 5 : Local and global acceptance criteria for MODUs (given in % of wastage) (1/1/2022)

Group of items	Description of items	1 Isolated area	2 Item	3 Group	4 Zone
ITEMS CONTRIBUTING TO THE LONGITUDINAL STRENGTH (TRANSVERSE SECTION)					
DECK ZONE (1)		-	-	-	10
1	Upperdeck plating, deck stringer plates and sheer strakes	30	20	10	-
2	Deck longitudinals	-	-	10	-
	web	30	20	-	-
	flange	25	15	-	-
NEUTRAL AXIS ZONE (1)		-	-	-	15
3	Side shell plating	25	20	15	-
4	Side shell longitudinals	-	-	15	-
	web	25	20	-	-
	flange	20	15	-	-
BOTTOM ZONE (1)		-	-	-	10
5	Bilge and bottom strakes and keel plate	25	20	10	-
6	Bottom girders	25	20	10	-
7	Bilge and bottom longitudinals	-	-	10	-
	web	30	20	-	-
	flange	25	15	-	-
8	Inner bottom plating	30	20	10	-
9	Inner bottom longitudinals	-	-	10	-
	web	30	20	-	-
	flange	25	15	-	-
OTHER ITEMS					
10	Transverse bulkheads (3)				
	plating	30	20	15	-
	stringer web	30	20	-	-
	stringer flange	25	15	-	-
	stiffener web	30	20	-	-
	stiffener flange	25	15	-	-
	brackets	30	20	-	-
11	Side frames				
	web	30	20	-	-
	flange	25	15	-	-
	brackets	30	20	-	-
12	Deck/'tweendeck frames				
	web	30	20	-	-
	flange	25	15	-	-
13	Floors				
	plating	30	20	-	-
14	Forward and aft peak bulkheads				
	plating	30	20	15	-
	stiffener web	30	20	-	-
	stiffener flange	25	15	-	-
<p>(1) Each zone is to be evaluated separately.</p> <p>(2) If continuous, to be included in item 1.</p> <p>(3) For deep tank bulkheads, the values "average of item" and "average of group" are to be increased by 5 (%).</p>					

Group of items	Description of items	1 Isolated area	2 Item	3 Group	4 Zone
15	Jack-up leg foundation:	-	-	10	-
	plating	25	20	-	-
	stringer web	25	20	-	-
	stringer flange	20	15	-	-
	stiffener web	30	20	-	-
	stiffener flange	25	15	-	-
16	Jack-up leg:	-	-	10	-
	plating	20	15	-	-
	column bracing	20 20	15 15	- -	- -
17	Jack-up spud can:	-	-	10	-
	plating	20	15	-	-
	stringer web	30	25	-	-
	stringer flange	25	20	-	-
	stiffener web	30	25	-	-
	stiffener flange	20	15	-	-
<p>(1) Each zone is to be evaluated separately.</p> <p>(2) If continuous, to be included in item 1.</p> <p>(3) For deep tank bulkheads, the values "average of item" and "average of group" are to be increased by 5 (%).</p>					

Figure 5 : FSRU: layout of items to be assessed - to be modified

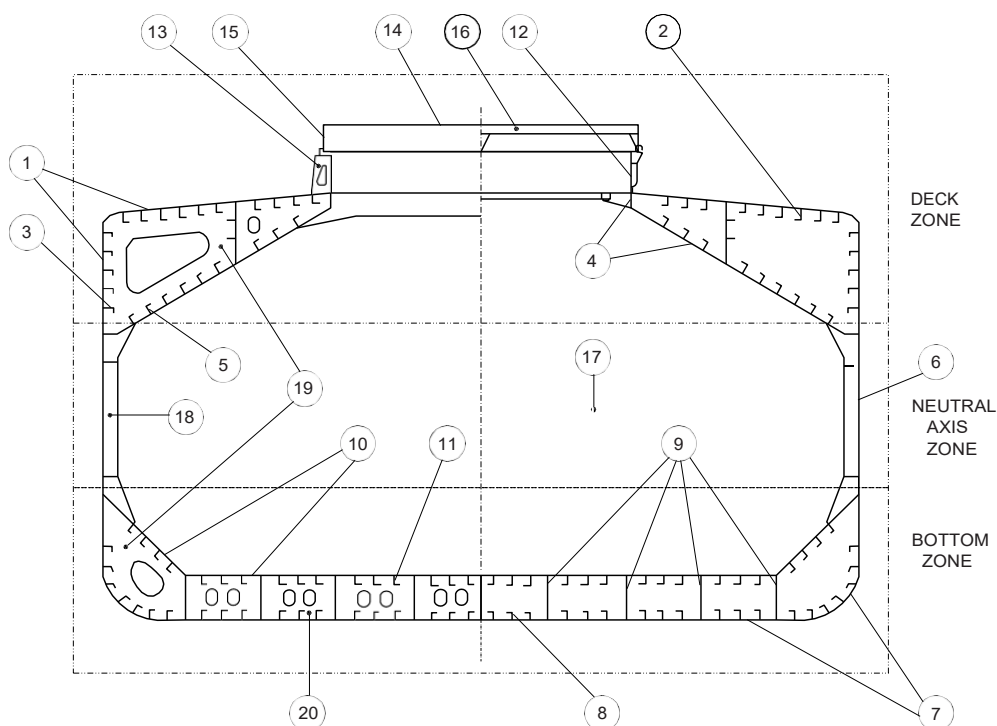

Table 6 : Local and global acceptance criteria for FSRUs (given in % of wastage)

Group of items	Description of items	1 Isolated area	2 Item	3 Group	4 Zone
ITEMS CONTRIBUTING TO THE LONGITUDINAL STRENGTH (TRANSVERSE SECTION)					
DECK ZONE (1)					
1	Strength deck plating, deck stringer, sheer strake and part of side shell plating in way of top side tanks or 0,1D from deck, as applicable, and inner side shell plating	25	20	10	-
2	Deck longitudinals	-	-	10	-
	web	25	20	-	-
	flange	20	15	-	-
3	Side and inner side shell longitudinals in way of top side tanks or 0,1D from deck, as applicable	-	-	10	-
	web	25	20	-	-
	flange	20	15	-	-
4	Top side tank sloped plating, including horizontal and vertical strakes	25	20	10	-
5	Longitudinals connected to top side tank sloped plating	-	-	10	-
	web	25	20	-	-
	flange	20	15	-	-
NEUTRAL AXIS ZONE (1)					
6	Side and inner side shell plating	25	20	15	-
7	Side shell longitudinals	-	-	15	-
	web	25	20	-	-
	flange	20	15	-	-
BOTTOM ZONE (1)					
8	Bilge and bottom plating and keel plate	25	20	10	-
<p>(1) Each zone is to be evaluated separately.</p> <p>(2) If continuous, to be included in item 1.</p>					

Group of items	Description of items	1 Isolated area	2 Item	3 Group	4 Zone
9	Bilge and bottom longitudinals web flange	- 25 20	- 20 15	10 - -	- - -
10	Bottom girders	25	15	10	-
11	Inner bottom plating and hopper tank sloped plating	25	20	10	-
12	Longitudinals connected to inner bottom and hopper tank sloped plating web flange	- 25 20	- 20 15	10 - -	- - -
OTHER ITEMS					
13	Transverse bulkheads plating stiffener web stiffener flange	25 25 20	20 20 15	15 - -	- - -
14	Side shell frames web flange brackets	25 20 20	20 15 15	- - -	- - -
15	Topside and hopper tank web frames web flange	25 20	20 15	- -	- -
16	Floors (bottom transverse) plating	25	15	-	-
17	Forward and aft peak bulkheads plating stiffener web stiffener flange	25 25 20	20 20 15	15 - -	- - -
<p>(1) Each zone is to be evaluated separately.</p> <p>(2) If continuous, to be included in item 1.</p>					

Figure 6 : FPSO / FSO: layout of items to be assessed

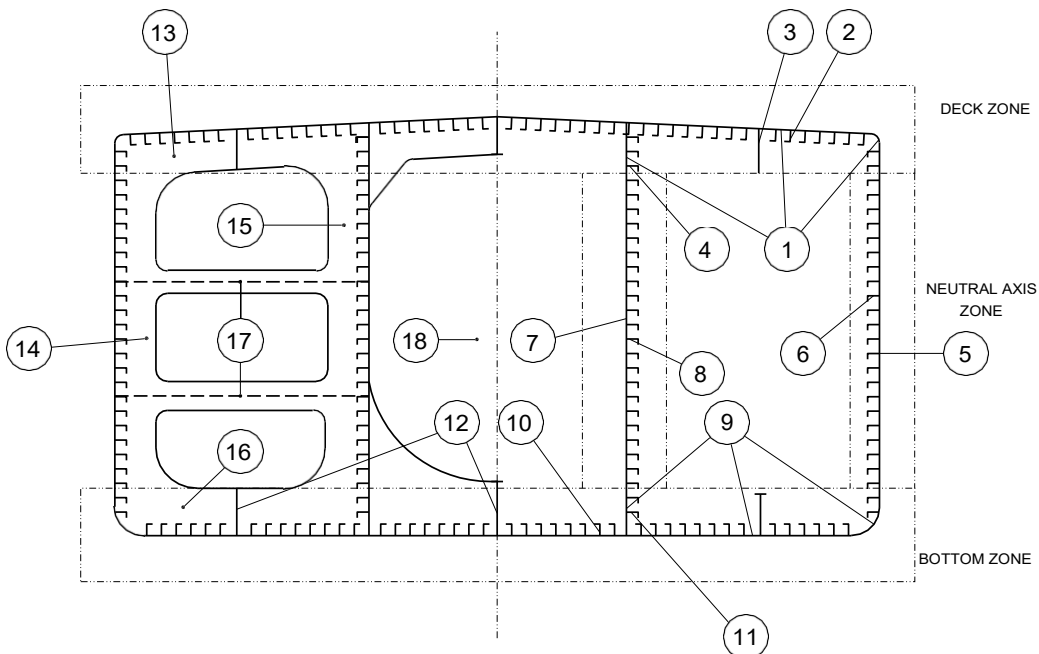

Table 7 : Local and global acceptance criteria for FPSOs / FSO (given in % of wastage)

Group of items	Description of items	1 Isolated area	2 Item	3 Group	4 Zone
ITEMS CONTRIBUTING TO THE LONGITUDINAL STRENGTH (TRANSVERSE SECTION)					
DECK ZONE (1)		-	-	-	10
1	Deck plating, deck stringer, sheer strake and longitudinal bulkhead upper strake (2)	25	20	10	-
2	Deck and sheer strake longitudinals	-	-	10	-
	web	25	20	-	-
	flange	20	15	-	-
3	Deck longitudinal girders	-	-	10	-
	web	25	20	-	-
	flange	20	15	-	-
4	Longitudinals connected to long. bulkhead upper strake (2)	-	-	10	-
	web	25	20	-	-
	flange	20	15	-	-
NEUTRAL AXIS ZONE (1)		-	-	-	15
5	Side shell plating (2)	25	20	15	-
6	Side shell longitudinals and stringers (2)	-	-	15	-
	web	25	20	-	-
	flange	20	15	-	-
7	Longitudinal bulkhead plating	25	20	15	-
8	Longitudinal bulkhead longitudinals and stringers	-	-	15	-
	web	25	20	-	-
	flange	20	15	-	-
BOTTOM ZONE (1)		-	-	-	10
9	Bilge and bottom strakes, longitudinal bulkhead lower strake and keel plate (2)	25	20	10	-
10	Bilge and bottom longitudinals (2)	-	-	10	-
	web	25	20	-	-
	flange	20	15	-	-
11	Longitudinals connected to longitud. bulkhead lower strake	-	-	10	-
	web	25	20	-	-
	flange	20	15	-	-
12	Bottom girders	-	-	10	-
	web	25	20	-	-
	flange	20	15	-	-
OTHER ITEMS					
13	Deck transverse web frame				
	web	25	20	-	-
	flange	20	15	-	-
	brackets / stiffeners	25	20	-	-
14	Side shell web frame				
	web	25	20	-	-
	flange	20	15	-	-
	brackets / stiffeners	25	20	-	-
<p>(1) Each zone is to be evaluated separately.</p> <p>(2) For double hull oil tankers, the structural elements of the inner skin (plating, longitudinals, girders, bulkheads) are to be included in the corresponding elements of the outer skin.</p> <p>(3) Including swash bulkheads, forward and aft peak bulkheads.</p>					

Group of items	Description of items	1 Isolated area	2 Item	3 Group	4 Zone
15	Longitudinal bulkhead web frame				
	web	25	20	-	-
	flange	20	15	-	-
16	Bottom transverse web frame				
	web	25	20	-	-
	flange	20	15	-	-
17	Cross tie				
	web	25	15	-	-
	flange	20	15	-	-
18	Transverse bulkheads (3)				
	plating	25	20	15	-
	stringer web	25	20	-	-
	stringer flange	20	15	-	-
	stiffener web	30	20	-	-
	stiffener flange	25	15	-	-
<p>(1) Each zone is to be evaluated separately.</p> <p>(2) For double hull oil tankers, the structural elements of the inner skin (plating, longitudinals, girders, bulkheads) are to be included in the corresponding elements of the outer skin.</p> <p>(3) Including swash bulkheads, forward and aft peak bulkheads.</p>					

APPENDIX 3

CRITERIA FOR LONGITUDINAL STRENGTH OF THE HULL GIRDER

1 General

1.1

1.1.1 These criteria are to be used for the evaluation of longitudinal strength of the unit's hull girder as required by Sec 2, [2.3.9].

In order for the evaluation of the unit's longitudinal strength to be recognised as valid, fillet welding between longitudinal internal members and hull envelopes is to be in sound condition so as to keep integrity of longitudinal internal members with hull envelopes.

Items [1.1.2] and [6] only apply to **FSO** and **FPSO**.

1.1.2 On **FSO** and **FPSO**, both for single and double hull construction over 10 years of age, the longitudinal strength of the unit's hull girder is to be evaluated in compliance with the requirements of this App 3 on the basis of the thickness measured, renewed or reinforced, as appropriate, during the class renewal survey.

The condition of the hull girder for longitudinal strength evaluation is to be determined in accordance with the methods specified in [6].

2 Calculation of transverse sectional areas of deck and bottom flanges of hull girder

2.1

2.1.1 The transverse sectional areas of deck zones and bottom zones (as defined in App 2, [4.3.4]) of the unit's hull girder are to be calculated by using the thickness measured, renewed or reinforced, as appropriate, during the class renewal survey.

2.1.2 If the diminution of sectional areas of either deck or bottom zones exceeds 10 % of their respective as-built area (i.e. original sectional area when the unit was built), either of the following measures is to be taken:

- renewal or reinforcement of the deck or bottom zones so that the actual sectional area is not less than 90% of the as-built area; or
- calculation of the actual section moduli (Z_{act}) of the transverse section of the unit's hull girder by applying the calculation method specified in [4], using the thickness measured, renewed or reinforced, as appropriate, during the class renewal survey.

3 Requirements for transverse section modulus of hull girder

3.1

3.1.1 The actual section moduli (Z_{act}) of the transverse section of the unit's hull girder calculated in accordance with [2.1.2]b) above is not to be less than 90% of the required section modulus Z_R or $Z_{R,MIN}$ for new buildings specified in Pt B, Ch 6, Sec 2, [4.2], whichever is the greater, provided that in no case is Z_{act} less than the diminution limit of the minimum section modulus (Z_{MC}) as specified in [5].

4 Calculation criteria of section moduli of midship section of hull girder

4.1

4.1.1 When calculating the transverse section modulus of the unit's hull girder, the sectional area of all continuous longitudinal strength members is to be taken into account.

4.1.2 Large openings, i.e. openings exceeding 2,5m in length or 1,2m in breadth and scallops, where scallop welding is applied, are always to be deducted from the sectional areas used in the section modulus calculation.

4.1.3 Smaller openings (manholes, lightening holes, single scallops in way of seams, etc.) need not be deducted provided that the sum of their breadths or shadow area breadths in one transverse section does not reduce the section modulus at deck or bottom by more than 3% and provided that the height of lightening holes, draining holes and single scallops in longitudinals or longitudinal girders does not exceed 25% of the web depth, for scallops of maximum 75mm.

4.1.4 A deduction-free sum of smaller opening breadths in one transverse section in the bottom or deck area of $0,06(B - \Sigma b)$ (where B = breadth of unit, Σb = total breadth of large openings) may be considered equivalent to the above reduction in section modulus.

4.1.5 The shadow area is to be obtained by drawing two tangent lines with an opening angle of 30° .

4.1.6 The deck modulus is related to the moulded deck line at side.

4.1.7 The bottom modulus is related to the base line.

4.1.8 Continuous trunks and longitudinal hatch coamings are to be included in the longitudinal sectional area provided they are effectively supported by longitudinal bulkheads or deep girders. The deck modulus is then to be calculated by dividing the moment of inertia by the following distance, provided this is greater than the distance to the deck line at side:

$$y_L = y(0,9 + 0,2x/B)$$

where:

y : distance from neutral axis to top of continuous strength member,

x : distance from top of continuous strength member to centreline of the unit.

x and y to be measured to the point giving the largest value of y_L .

4.1.9 Longitudinal girders between multi-hatchways are to be considered by means of special calculations.

5 Diminution limit of minimum longitudinal strength of units in service

5.1

5.1.1 The diminution limit of the minimum section modulus Z_{mc} , in cm^3 , of units in service is given by the following formula:

$$Z_{mc} = cL^2 B(C_b + 0,7)k$$

where:

L : length of units. L is the distance, in meters, on the summer load waterline from the fore side of stem to the after side of the rudder post, or the centre of the rudder stock if there is no rudder post. L is not to be less than 96%, and need not be greater than 97%, of the extreme length on the summer load waterline. In units with unusual stern and bow arrangement the length L may be specially considered.

B : greatest moulded breadth in metres.

C_b : moulded block coefficient at draught d corresponding to summer load waterline, based on L and B . C_b is not to be taken less than 0.60, according to the formula:

$$C_b = \frac{\text{moulded displacement (m}^3\text{) at draught } d}{LBd}$$

c : 0,9 c_n (the value of C_n is given in Tab 1)

k : material factor, e.g.:

- $k = 1$ for mild steel with yield stress of 235N/mm² and over;
- $k = 0,78$ for high tensile steel with yield stress of 315 N/mm² and over,
- $k = 0,72$ for high tensile steel with yield stress of 355 N/mm² and over.

5.1.2 Scantlings of all continuous longitudinal members of the unit's hull girder based on the section modulus requirement in [5.1.1] above are to be maintained within 0,4 L amidships. However, in special cases, based on considera-

tion of the type of unit, hull form and loading conditions, the scantlings may be gradually reduced towards the end of 0,4 L part, bearing in mind the desire not to inhibit the unit's loading flexibility.

5.1.3 However, the above standard may not be applicable to units of unusual type or design, e.g. for units of unusual main proportions and/or weight distributions.

6 FPSOs and FSOs - Sampling method of thickness measurements for longitudinal strength evaluation and repair methods

6.1 Extent of longitudinal strength evaluation

6.1.1 Longitudinal strength is to be evaluated within 0,4 L amidships for the extent of the hull girder length that contains tanks therein and within 0,5 L amidships for adjacent tanks which may extend beyond 0,4 L amidships, where tanks means ballast tanks and cargo tanks.

6.2 Sampling method of thickness measurement

6.2.1 Pursuant to the requirements of Ch 4, Sec 2, [6.4] for FSO or Ch 4, Sec 3, [7.4] for FPSO, transverse sections are to be chosen such that thickness measurements can be taken for as many different tanks in corrosive environments as possible, e.g. ballast tanks sharing a common plane boundary with cargo tanks fitted with heating coils, other ballast tanks, cargo tanks permitted to be filled with sea water and other cargo tanks. Ballast tanks sharing a common plane boundary with cargo tanks fitted with heating coils and cargo tanks permitted to be filled with sea water are to be selected where present.

6.2.2 The minimum number of transverse sections to be sampled is to be in accordance with Ch 4, Sec 2, Tab 3 and Tab 4 for FSO of single hull and double hull construction respectively or Ch 4, Sec 3, Tab 3 and Tab 4 for FPSO of single hull and double hull construction respectively. The transverse sections are to be located where the largest thickness reductions are suspected to occur or are revealed from deck and bottom plating measurements prescribed in [6.2.3] and are to be clear of areas which have been locally renewed or reinforced.

6.2.3 At least two points are to be measured on each deck plate and/or bottom shell plate required to be measured within the cargo area in accordance with the requirements of Ch 4, Sec 3, Tab 3 and Tab 4 for FSO of single hull and hull construction respectively or Ch 4, Sec 4, Tab 3 and Tab 4 for FPSO of single hull double hull construction respectively.

6.2.4 Within 0,1 D (where D is the unit's moulded depth) of the deck and bottom at each transverse section to be measured in accordance with the requirements of Ch 4, Sec 2, Tab 3 and Tab 4 for FSO of single hull and double hull construction respectively or Ch 4, Sec 3, Tab 3 and Tab 4 for

FPSO of single hull and double hull construction respectively, every longitudinal and girder is to be measured on the web and face plate, and every plate is to be measured at one point between longitudinals.

625 For longitudinal members other than those specified in [6.2.4] to be measured at each transverse section in accordance with the requirements of Ch 4, Sec 2, Tab 3 and Tab 4 for **FSO** of single hull and double hull construction respectively or Ch 4, Sec 3, Tab 3 and Tab 4 for **FPSO** of single hull and double hull construction respectively, every longitudinal and girder is to be measured on the web and face plate, and every plate is to be measured at least in one point per strake.

626 The thickness of each component is to be determined by averaging all of the measurements taken in way of the transverse section on each component.

6.3 Additional measurements where the longitudinal strength is deficient

631 Where one or more of the transverse sections are found to be deficient in respect of the longitudinal strength requirements given in this App 3, the number of transverse sections for thickness measurement is to be increased such that each tank within the 0,5L amidships region has been sampled. Tank spaces that are partially within, but extend beyond, the 0,5L region are to be sampled.

632 Additional thickness measurements are also to be performed on one transverse section forward and one aft of each repaired area to the extent necessary to ensure that the areas bordering the repaired section also comply with the requirements of Ch 4, Sec 2 for **FSO** or Ch 4, Sec 3 for **FPSO**.

6.4 Effective repair methods

641 The extent of renewal or reinforcement carried out to comply with this App 3 is to be in accordance with [6.4.2].

642 The thickness diminution in way of the butt-joint of each joining member forward and aft of the replaced member (plates, stiffeners, girder webs and flanges, etc.) is not to be within the substantial corrosion range (75% of the allowable diminution associated with each particular member or between $t_{net} + 0,5mm$ and t_{net} for units assigned with the additional class notation **CSR**). Where differences in thickness at the butt-joint exceed 15% of the lower thickness, a transition taper is to be provided.

643 Alternative repair methods involving the fitting of straps or structural member modification are subject to special consideration. When considered, the fitting of straps is to be limited to the following conditions:

- to restore and/or increase longitudinal strength;
- the thickness diminution of the deck or bottom plating to be reinforced is not within the substantial corrosion range (75% of the allowable diminution associated with the deck plating);
- the alignment and arrangement, including the termination of the straps, are in accordance with a standard recognised by the Society;
- the straps are continuous over the entire 0,5L amidships length; and
- continuous fillet welding and full penetration welds are used for butt welding and, depending on the width of the strap, for slot welds. The welding procedures applied are acceptable to the Society.

644 The existing structure, adjacent to replacement areas and in conjunction with the fitted straps, etc., is to be capable of withstanding the applied loads, taking into account the buckling resistance and the condition of welds between the longitudinal members and hull envelope plating.

Table 1 : Values of C_n

	$L < 90$	$90 \leq L < 300$	$300 \leq L \leq 350$	$350 < L \leq 500$
C_n	$(118 - 0,36L) \cdot L/1000$	$10,75 - [(300 - L)/100]^{1,5}$	10,75	$10,75 - [(L - 350)/150]^{1,5}$

Part A
Classification and Surveys

Chapter 3

SCOPE OF SURVEYS (all units)

SECTION 1	SURVEY FOR NEW CONSTRUCTION
SECTION 2	SURVEY FOR ASSIGNMENT OF CLASS OF A UNIT IN SERVICE
SECTION 3	ANNUAL SURVEY
SECTION 4	INTERMEDIATE SURVEY
SECTION 5	CLASS RENEWAL SURVEY
SECTION 6	BOTTOM SURVEY
SECTION 7	SHAFT SURVEY
SECTION 8	BOILER SURVEY
APPENDIX 1	CLASS REQUIREMENTS AND SURVEYS OF LAID-UP UNITS

SECTION 1

SURVEY FOR NEW CONSTRUCTION

1 Hull

1.1 Plans and documents

1.1.1 When a unit is requested for classification with the Society during building, construction plans and all necessary documents relevant to the hull, machinery and equipment, as detailed in the Rules, are to be submitted for approval of the Society before the work is commenced. Any subsequent modifications or additions to the structure, arrangements, systems or equipment indicated on the approved plans and documents are also to be submitted for approval.

1.1.2 Copies of approved plans (showing the unit as built), essential certificates and records, the Operating Manual and loading and other instruction manuals are to be readily available for use when required by the Society's Surveyors, and is required to be kept on board.

1.1.3 (1/7/2021)

A Cable Transit Seal Systems Register (Register), is to be provided by the shipbuilder for watertight cable transits. The Register can be in either a hard copy or digitized media. For an example of a register see Fig 1 - "Recommendatory Sample - Cable Transit Seal Systems Register". It is to include a marking / identification system, documentation referencing manufacturer manual(s) for each type of cable transit installed, the Type Approval certification for each type of transit system, applicable installation drawings, and a recording of each installed transit documenting the as built condition after final inspection in the shipyard. This is to include sections to record any inspection, modification, repair and maintenance.

For manned vessels the Register is to be held onboard of the vessel. For unmanned vessels, if a suitable storage location does not exist onboard, the Register may be held ashore. The Register is to be readily available for the attending Surveyor.

1.2 Materials

1.2.1 (1/1/2011)

Materials used in the construction of process plant and riser systems are to comply with the requirements in Ch 2, Sec 1, [2.1.5].

1.3 Formal safety case

1.3.1 Where classification is to be based on a formal safety case approach, special consideration will be given by the

Society to the use of materials in accordance with internationally recognized Codes and Standards.

2 Survey during construction

2.1 Special survey

2.1.1 New units intended for classification by the Society are to be built according to special survey requirements. From the commencement of work until the completion of the unit, the Surveyors are to verify that the materials, workmanship and arrangements are satisfactory and compliant with the Rules. Any items found not to be in accordance with the Rules or the approved plans, or any material, workmanship or arrangements found to be unsatisfactory, are to be rectified.

2.2 Special surveys of facultative plants / systems

2.2.1 (1/1/2011)

When the process plant and riser systems of a unit are constructed under survey of the Society, this survey is to relate to the period from the commencement of the work until the final test under working conditions. Any items found not to be in accordance with the Rules or the approved plans, or any material, workmanship or arrangements found to be unsatisfactory, are to be rectified.

2.2.2 (1/1/2011)

When remote and/or automatic control equipment, alarms and safeguards are fitted to the process plant and riser systems, the equipment is to be arranged, installed and tested in accordance with the Society's Rules.

2.3 Surveys of Watertight Cable Transits

2.3.1 (1/7/2021)

Watertight cable transit seal systems are to be inspected in accordance with item 12 of Table 1 of Pt A, Ch 3, Sec 1 of the Rules for the Classification of Ships.

3 Assignment of double or dual class for New Construction

3.1 Assignment of double class for New Construction

3.1.1 (1/2/2021)

Whenever it is requested by the Shipyard/Owner to survey a new building under double class provisions of [1] and [2] apply.

3.2 Assignment of dual class for New Construction

3.2.1 (1/2/2021)

Whenever it is requested by the Shipyard/Owner to survey a new building under dual class:

- a) review and approval of plans, as appropriate, for the newbuilding are to be performed in accordance with

the trilateral agreement referred to in Ch 2, Sec 1, [2.5.1];

- b) in application of the requirement of [1] and [2], survey during fabrication, construction and testing of the vessel are to be performed in accordance with the trilateral agreement referred to in Ch 2, Sec 1, [2.5.1], and/or the bilateral agreement adopted by the two Societies, if any, clearly defining the scope of work of each Society.

Figure 1 : Recommendatory Sample - Cable Transit Seal Systems Register (1/7/2021)

Name of Ship: Sample
 IMO No: 12345
 Place: Hamburg
 Date: XX/XX/2017

Inspected by: Smith
 Transits 4
 Total Openings 4

Drawing number	TRANSIT ID	Location	Inspected side		BRAND	FRAME		Type Approved	CONDITION(G,F,P)	INSPECTED	REPAIRED	MODIFIED	MAINTAINED	NOTES:	Checked by	DATE
			F	B		Type	Opening number									
G/A-07-1047-000-883	TT-MCT-011				C	id= 50	x							NVD	PTO	26/02/2015
G/A-07-1047-000-883	TT-MCT-012				C	450x200	x							NVD	PTO	26/02/2015
G/A-07-1047-000-883	TT-MCT-013				C	550x200	x							NVD	PTO	26/02/2015
G/A-07-1047-000-883	TT-MCT-014				C	750x200	x							Open, drilled hole not closed	PTO	26/02/2015

SECTION 2

SURVEY FOR ASSIGNMENT OF CLASS OF A UNIT IN SERVICE

1 Surveys required by IACS Procedural Requirement PR 1A

1.1 Transfer to the Society's class of a unit in service classed by another QSCS Classification Society and in full compliance with all applicable and relevant IACS Resolutions

1.1.1 General

Surveys for assignment of class may be credited as periodical surveys for maintenance of class, provided that the losing Society is a QSCS Classification Society as defined in Ch 2, Sec 1, [1.1.1]. In this case, all recommendations due for compliance at that periodical survey are to be complied with.

1.1.2 Surveys (1/1/2014)

Notwithstanding the records indicating that all surveys are up-to-date, a survey for assignment of class is held by the Society, the extent of which is based on the age of the unit and the losing Society's class status as follows:

a) Hull:

- 1) for units less than 5 years of age the survey takes the form of an annual survey;
- 2) for units between 5 and 10 years of age the survey is to include an Annual Survey and inspection of twenty percent of ballast spaces;
- 3) for units of 10 years of age and above but less than 20 years of age, the survey is to include an Annual Survey and inspection of twenty percent of ballast spaces and twenty percent of cargo spaces;
- 4) for all units which are 20 years of age and above, the survey has the scope of a class renewal survey (this is also applicable to units having their hull under continuous survey);
- 5) in the context of applying items 4) above, if dry-docking of the unit is not due at the time of transfer, consideration can be given to carrying out an underwater examination in lieu of dry-docking.
- 6) for site specific Floating Production and/or Storage Units which have been converted from other ships, the survey is to take the form of an Annual Survey and also include inspection of twenty percent of ballast spaces and twenty percent of cargo spaces until 20 years have elapsed since conversion.

After 20 years, the survey is to have the scope of a Special Survey.

- 7) in the context of applying items 1) to 6) above, as applicable:

- if the class entry survey is to be credited as a periodical survey for maintenance of class, consideration may be given by the Society to the acceptance of thickness measurements taken by the losing society provided they were carried out within the applicable survey window of the periodical survey in question;
- if the class entry survey is not to be credited as a periodical survey for maintenance of class, consideration may be given by the Society to the acceptance of thickness measurements taken by the losing society provided they were carried out within 15 months prior to completion of the class entry survey when it is within the scope of a Class Renewal Survey, or within 18 months prior to completion of the class entry survey when it is within the scope of an Intermediate Survey.

In both cases, the thickness measurements are to be reviewed by the Society for compliance with the applicable survey requirements, and confirmatory gaugings are to be taken to the satisfaction of the Society.

- 8) in the context of applying 3) to 6) above, as applicable, tank testing for units over 15 years of age is not required to be carried out unless the survey is credited as a periodical survey for maintenance of class. If the class entry survey is to be credited as a periodical survey for maintenance of class, consideration may be given by the Society to the acceptance of the tank testing carried out by the losing Society provided they were carried out within the applicable survey window of the periodical survey in question.

b) Machinery:

A general examination of all essential machinery is held and includes the following:

- 1) examination under working conditions of fuel oil burning equipment of boilers, economisers and steam/steam generators. The adjustment of safety valves of this equipment is to be verified by checking the records on the unit;
- 2) all pressure vessels;
- 3) insulation resistance, generator circuit-breakers, preference tripping relays and generator prime mover governors are to be tested and paralleling and load sharing to be proved (Note 1);
- 4) in all cases, navigating lights and indicators are to be examined and their working and alternative sources of power verified;
- 5) bilge pumps, emergency fire pumps and remote control for oil valves, fuel oil pumps, lubricating oil

pumps and forced draught fans are to be examined under working conditions;

- 6) recirculating and ice clearing arrangements, if any;
- 7) the main and all auxiliary machinery necessary for operation of the unit at sea together with essential controls and steering gear is to be tested under working conditions. Alternative means of steering are to be tested. A short sea trial is to be held at the Surveyor's discretion if the unit has been laid up for a long period;
- 8) initial start arrangements are to be verified;
- 9) in the case of FSO, FPSO and FSRU, the hydrocarbon system and electrical installation in way of hazardous spaces are to be checked for compliance with the Society's Rule requirements. Where intrinsically safe equipment is installed, the Surveyor is to satisfy himself that a recognised authority has approved such equipment. The safety devices, alarms and essential instruments of the inert gas system are to be verified and the plant generally examined to ensure that it does not constitute a hazard to the unit (Note 1).

Note 1: For the transfer of class or adding class at ship's delivery, items listed in 3) and 9) may be verified by reviewing the unit's records.

1.2 Transfer to the Society's class of a unit surveyed during construction by another QSCS Classification Society and in full compliance with all applicable and relevant IACS Resolutions, at unit's delivery

1.2.1 General

A survey for assignment of class at unit's delivery is to be held by the Society, the extent of which is that of an annual survey as minimum.

2 Surveys required by IACS Procedural Requirement PR 1B

2.1 Addition of the Society's class to a unit in service classed by another QSCS Classification Society and in full compliance with all applicable and relevant IACS Resolutions

2.1.1 General (1/7/2009)

Survey requirements for adding the Society's class to a unit in service are indicated in [2.1.2] and [2.1.3].

2.1.2 Surveys for double class units

The requirements of [1.1.2] apply.

2.1.3 Surveys for dual class units (1/7/2015)

Notwithstanding the records indicating that all surveys are up-to-date, a survey for assignment of class is held by the Society, the extent of which is that of an annual survey as a minimum.

2.2 Addition of the Society's class to a unit surveyed during construction by another QSCS Classification Society and in full compliance with all applicable and relevant IACS Resolutions, at unit's delivery

2.2.1 General (1/7/2015)

A survey to add the Society's class at unit's delivery is to be held by the Society, the extent of which is that of an annual survey as a minimum.

3 Surveys required by IACS Procedural Requirement PR1D

3.1 Units in service classed with a QSCS Classification Society but not in full compliance with all applicable and relevant IACS Resolution or not classed with a QSCS Classification Society or not classed at all

3.1.1 General (1/7/2015)

In this case, the class of the unit will be assigned upon a preliminary review of the documentation listed in Ch 2, Sec 2, [3.6.2] and subsequent satisfactory completion of the surveys, the extent and scope of which are given below.

Where the unit has, during any portion of the five years prior to the request for classification being received, been previously classed by:

- a) the Society, or
- b) a Society subject to verification of compliance with QSCS at the time it classed the unit,

then survey requirements may be specially considered but are not to be less than those required by IACS Procedural Requirement PR1A as per [1.1.2].

3.1.2 Surveys (1/1/2015)

The minimum extent and scope of the admission to class entry survey is to be based on the age and type of the unit as follows:

- a) class renewal survey of hull, including thickness measurements
- b) class renewal survey of machinery, inclusive of pressure vessel survey(s), as applicable
- c) bottom survey in dry condition
- d) tailshaft survey(s)
- e) main boiler survey(s) and auxiliary boiler survey(s), as applicable
- f) In addition to all other periodical surveys linked to specific service notations and/or additional class notations and/or special installations the unit is provided with.

The Society may request further examinations, tests and measurements, including but not limited to material testing, non-destructive testing, hydraulic and hydrostatic tests and sea trials.

4 Reassignment of Class

4.1 Conditions for reassignment Surveys

4.1.1 General (1/7/2015)

The survey for reassignment of class consists of an admission to class survey, the consistency of which is determined by the Society on a case by case basis. Account may be

taken of any periodical surveys held in the former period of class with the Society.

At the request of the Owner, a unit which was previously classed with the Society, subsequently withdrawn from class and has not been classed since may have the class reassigned subject to an admission to class survey. If applicable and appropriate, account may be taken of any periodical surveys held in the former period of class with the Society.

SECTION 3

ANNUAL SURVEY

1 General

1.1

1.1.1 The requirements of this Section apply to annual surveys of all units. The specific requirements for annual surveys related to service notations and additional class notations assigned to units are addressed in Chapter 4 and Chapter 5, respectively.

1.1.2 At the time of annual surveys, the unit is to be generally examined. The survey is to include a visual inspection of the hull, equipment and machinery of the unit and some tests thereof, so far as necessary and practicable in order to verify that the unit is in a satisfactory and efficient general condition and is properly maintained.

1.1.3 Owners are reminded that, in compliance with the requirements in Ch 2, Sec 2, [6.3], any modification to the hull, equipment and machinery affecting the classification of the unit is to be made known to the Society.

2 Hull

2.1 Scope

2.1.1 The survey consists of an examination for the purpose of ensuring, as far as practicable, that the hull, structure, openings, closing appliances, equipment, related piping, machinery and related systems are maintained in a satisfactory condition.

3 Hull

3.1 Hull, structure and equipment

3.1.1 The Surveyors are to be satisfied that no material alterations have been made to the unit, its structural arrangements, subdivision, superstructure, fittings, and closing appliances upon which the stability calculations or the load line assignment is based.

The survey is to include a general external examination and testing, where appropriate, verifying the efficient condition of the following items, as applicable:

- a) outer shell plating above the waterline, relevant shell doors and accessible parts of the rudder(s), where applicable
- b) plating of freeboard deck and exposed decks, superstructures, with their openings and means of closure
- c) openings on exposed decks, with their coamings and their means of closure and securing arrangements
- d) machinery casings and covers, companionways, and deck houses protecting openings.
- e) sidescuttles and deadlights, chutes and other openings with their means of closure
- f) bulwarks, guard rails, freeing ports, gangways and life-lines, ladders
- g) scuppers and sanitary discharges, valves on discharge lines and their controls
- h) ventilators, air pipes, overflow pipes and gas vent pipes, with their means of closure and flame screens, where required
- i) all automatic air pipe heads installed on exposed decks (see Note 2).
- j) fittings and appliances for timber deck cargoes, where applicable
- k) weld connections between air pipes and deck plating.
- l) deck equipment such as lifeboat davit foundations, bollards, fairleads, hawse pipes, etc., masts and associated rigging, including lightning conductors
- m) equipment of chain cables for anchors, windlass, mooring lines and mooring winches, where required
- n) deck fittings, their pedestals, if any, and the hull structures associated with towing and mooring
- o) accessible areas on mooring buoys and mooring towers,
- p) watertight bulkheads, their watertight doors and associated local and remote controls, and their watertight penetrations
- q) main and auxiliary steering arrangements, including their associated equipment and control systems, and manoeuvring gear
- r) engine room and other dry spaces. Machinery casings and covers, companionways, and deck houses protecting openings
- s) where fitted, helicopter deck and its supporting structure, safety net and arrangements for the prevention of sliding
- t) availability of loading manual or, where required, electronic loading instrument, including standard test
- u) availability of approved stability documentation
- v) availability on board of an approved Operating Manual,
- w) accuracy of the shipboard computer for stability calculations (see Note 3).

Note 1: Due attention is also to be given to fuel oil piping passing through ballast tanks, which is to be pressure tested where doubts arise.

Note 2: Air pipe heads installed on exposed decks are those extending above the freeboard deck or superstructure decks.

Note 3: It is the responsibility of the Master to check the accuracy of the shipboard computer for stability calculations at each annual survey by applying at least one approved test condition (see Pt B,

Ch 11, Sec 2, [4.5]) of the Rules for the Classification of Ships. If a Surveyor of the Society is not present for the computer check, a copy of the test condition results obtained by the computer check is to be retained on board as documentation of satisfactory testing for the Surveyor's verification. The testing procedure is to be carried out in accordance with Pt B, Ch 11, Sec 2, [4.5.9] of the Rules for the Classification of Ships.

3.2 Ballast tanks

3.2.1 Examination of ballast tanks when required as a consequence of the results of the class renewal survey and intermediate survey is to be carried out. When considered necessary by the Surveyor, or where extensive corrosion exists, thickness measurement is to be carried out. If the results of these thickness measurements indicate that substantial corrosion is found, then the extent of thickness measurements is to be increased to determine the extension of areas of substantial corrosion. Sec 5, Tab 2 may be used as guidance for these additional measurements. These extended thickness measurements are to be carried out before the annual survey is credited as completed.

3.3 Suspect areas

3.3.1 Suspect areas identified at previous surveys are to be examined. Thickness measurements are to be taken of the areas of substantial corrosion and the extent of thickness measurements is to be increased to determine the extension of areas of substantial corrosion. Sec 5, Tab 3 may be used as guidance for these additional thickness measurements. These extended thickness measurements are to be carried out before the annual survey is credited as completed.

3.4 Turrets

3.4.1 Where applicable, the following items are to be examined where accessible:

- a) the hull and deck structure around turret openings and turret areas
- b) turret bearings and seals
- c) mooring arms and yokes
- d) mooring arm pivots and bearings
- e) process plant support stools and deck structure in way
- f) swivel stack support structure
- g) swivel stack bearing and seals
- h) mooring hawser line and mooring arm attachments to the hull structure
- i) mooring hawser to buoy.

3.5 Positional mooring system

3.5.1

A periodic inspection program of the component parts of the mooring system is to be developed by the Owners/operators and submitted to the Society for approval.

At each annual survey a part of such items is to be examined.

Scope of annual survey is to determine the condition of mooring system on the basis as far as practicable of examination of above water items in order to verify their satisfactory conditions.

In particular following items are to be examined:

- a) Anchor chain stopper structural arrangements and relevant foundations
- b) Anchor chain catenary angles for verifying compliance with design values. In case of anchor cables their tensions are to be checked against allowable tensions
- c) Cable or chain in contact with fairleads, etc.
- d) Cable or chain in way of winches, stoppers and splash zone.

3.6 Watertight Cable Transits

3.6.1 (1/7/2021)

The Register (see Sec 1, [1.1.3]) is to be reviewed to confirm it is being maintained and as far as practicable the transits are to be examined to confirm their satisfactory condition.

3.6.2 (1/7/2021)

Where there are records entered since the last annual survey of any disruption to the cable transits or installation of new cable transits, the satisfactory condition of those transits, in accordance with the manufacturer's requirements and in accordance with the requirements of type approval, is to be confirmed by review of records and, if deemed necessary, by examination.

It is to be confirmed that, where specified, appropriate specialized tools have been used.

The results are to be recorded in the Register against the specific cable transit.

4 Machinery and systems

4.1 General machinery installations

4.1.1 The survey of general machinery installations is to cover the following items:

- general examination of machinery and boiler spaces with particular attention to the fire and explosion hazards

- general examination of the machinery, steam, hydraulic, pneumatic and other systems and their associated fittings, for confirmation of their proper maintenance
- testing of the means of communication and order transmission between the navigating bridge and the machinery control positions and other control stations
- confirmation that the rudder angle indicator on the bridge is in working order
- examination, as far as practicable, of the bilge pumping systems and bilge wells, including operation of the pumps, remote reach rods and level alarms, where fitted
- visual examination of the condition of any expansion joints in sea water systems
- external examination of pressure vessels other than boilers and their appurtenances, including safety devices, foundations, controls, relieving gear, high pressure piping, insulation and gauges
- visual examination of mechanical components used for cooling and maintaining an ambient temperature lower than 45°C (see Pt C, Ch 2, Sec 2, [1.2.2] of the Rules for the Classification of Ships).

4.1.2 When the unit is equipped with thruster installations, the annual survey is to include:

- an external examination of the machinery installation
- an operating test of the complete installation.

4.2 Boilers

4.2.1 For main and auxiliary boilers, the annual survey consists of an external examination of boilers and their appurtenances, including safety devices, foundations, controls, relieving, high pressure and steam escape piping, insulation and gauges.

4.2.2 For thermal oil heaters, a functional test while in operation is to be carried out, during which the following items are checked:

- the heater for detection of leakages
- the condition of the insulation
- the operation of indication, control and safety devices
- the condition of remote controls for shut-off and discharge valves

A satisfactory analysis of the quality of oil is to be made available to the Surveyor.

4.2.3 For exhaust gas thermal oil heaters, in addition to the requirements of [4.2.2], a visual examination and a tightness testing to the working pressure of the heater tubes are to be carried out.

4.3 Electrical machinery and equipment

4.3.1 The survey of electrical machinery and equipment is to cover the following items:

- general examination, visually and in operation, as feasible, of the electrical installations for power and lighting, in particular main and emergency generators, electric motors, batteries, switchboards, switchgears, cables and circuit protective devices, indicators of electrical insulation and automatic starting, where provided, of emergency sources of power
- checking, as far as practicable, the operation of emergency sources of power and, where they are automatic, also including the automatic mode.

4.3.2 The survey is also to cover electrical components used for cooling and maintaining an ambient temperature lower than 45°C (see Pt C, Ch 2, Sec 2, [1.2.2] of the Rules for the Classification of Ships).

4.3.3 The survey is also to cover the bridge control of propulsion machinery, and related arrangements (alarms and safety devices), when fitted.

The survey of an automated installation covered by an additional class notation is detailed in Chapter 5.

4.4 Swivel stack

4.4.1 Swivel stack including valves, manifolds and pipe connections are to be generally examined under working conditions with special attention to damage due to mechanical handling and all seals are to be checked for tightness. Suitable leakage tests may be carried out at Surveyor's discretion.

5 Safety and communication systems and hazardous areas

5.1

5.1.1 Safety and protection systems

The surveyor is to be satisfied as to the efficient condition as far as practicable of the following systems in accordance with Part C and Part E:

- a) Fire and gas alarm indication and control systems.
- b) Systems for broadcasting safety information.
- c) Protection system against gas ingress into safe areas.
- d) Protection system against gas escape in enclosed and semi-enclosed hazardous areas.
- e) Emergency shutdown (ESD) systems.
- f) Ventilation arrangements in hazardous areas.
- g) Verification of the operation of manual and/or automatic doors.
- h) Protection of accommodation areas against the ingress of smoke.
- i) Protection system against flooding including:
 - 1) Water detection alarm systems for watertight bracings, columns, pontoons, footings, void watertight spaces and chain lockers.
 - 2) Bilge level detection and alarm systems on column stabilised units and in machinery spaces on ship units.
 - 3) Remote operation and indication of watertight doors and hatch covers and other closing appliances.

5.1.2 Electrical equipment in hazardous areas

For units where flammable mixtures may be present, a general examination of electrical equipment located in hazardous areas and spaces is to be made, to ensure that it is suitable for the application and that the integrity of safe type electrical equipment has not been impaired due to corrosion, missing bolts, etc. Cable runs are to be examined so far as can be seen for sheath and armouring defects and to ensure that means of supporting the cable are in good order. Alarms and interlocks associated with pressurized equipment or spaces are to be tested for correct operation.

5.1.3 Automatic shutdown

Satisfactory operation of automatic shut down devices and alarms is to be verified.

6 Import/Export systems

6.1

6.1.1 At each annual survey, the import and export (when requested for classification) systems are to be examined as far as can be seen and placed in satisfactory condition as necessary. In addition, the following items are to be examined, placed in satisfactory condition and reported upon where applicable:

- a) A general examination is to be performed on all electrical and fluid swivels, flexible risers, floating hoses,

cargo piping and valves associated with the import and export systems, expansion joints, seals, etc.

- b) The fluid swivels are to be examined for signs of leaks through their "tell-tale" apertures.
- c) Records of maintenance are to be reviewed, including records of hose hydrostatic testing.
- d) Navigational aids for all floating hoses are to be examined and functionally tested.
- e) Riser tensioning arrangements are to be examined for proper functioning order.
- f) All electrical equipment, fitted in hazardous location is to be examined for integrity and suitability for its continued use.

SECTION 4

INTERMEDIATE SURVEY

1 General

1.1

1.1.1 The requirements of this Section apply to intermediate surveys of all units. The specific requirements for intermediate surveys related to service notations and additional class notations assigned to units are addressed in Chapter 4 and Chapter 5, respectively.

1.1.2 The intermediate survey is to include examination and checks on a sufficiently extensive part of the structure to show that the structures of the unit are in satisfactory condition so that the unit is expected to operate until the end of the current period of class, provided that the unit is properly maintained and other surveys for maintenance of class are duly carried out during this period.

2 Hull and machinery requirements

2.1

2.1.1 Units between 5 and 10 years old

For all units between 5 and 10 years of age, a general, internal examination of representative spaces used for water ballast and other spaces is to be carried out as follows.

- a) Column-stabilized units - Representative ballast tanks in pontoons, lower hulls, and free-flooding compartments as accessible, and at least two ballast tanks in columns and upper hull, if applicable.
- b) Self-elevating units - representative ballast tanks and at least two representative pre-load tanks. Accessible free-flooding compartments in mat or footings.
- c) Ship units - one peak tank and at least two other representative ballast tanks between the peak bulkheads used primarily for water ballast.
- d) All unit types - Particular attention is to be given to corrosion control systems in ballast tanks, free-flooding areas and other locations subjected to sea-water from both sides where accessible.

For tanks other than independent double bottom tanks, where a protective coating is found in POOR condition, as defined in Ch 2, Sec 2, [2.2.11], or other defects are found, where a soft coating has been applied or where a protective coating was not applied from the time of construction, the examination is to be extended to other ballast tanks of the

same type. For independent double bottom tanks where substantial corrosion or other defects are found, the examination is to be extended to other ballast tanks of the same type.

2.1.2 Units over 10 years old

For all unit types over 10 years of age an internal examination of all spaces used for water ballast and free-flooding areas where accessible is to be carried out.

2.1.3 If the examination of spaces in [2.1.1] and [2.1.2] reveal no visible structural defects, the examination may be limited to verification that the corrosion prevention system remains effective. If considered necessary by the Surveyor, thickness measurements may be required.

2.1.4 For spaces used for water ballast, excluding independent double bottom tanks, if the protective coating, is found to be in POOR condition, as defined in Ch 2, Sec 2, [2.2.11] and it has not been repaired, where a soft coating has been applied or where a protective coating was not applied from the time of construction, the spaces in question are to be internally examined and thickness measurements carried out as considered necessary at annual surveys.

2.1.5 When such breakdown of protective coating is found in independent ballast double bottom tanks, the tanks in question may be internally examined at annual surveys.

2.1.6 In addition to the requirements above, structures identified at the previous class renewal survey as having substantial corrosion are to be examined and thickness measured.

2.1.7 Electrical generating sets

For all units the electrical generating sets are to be examined to verify that number, type and rating of generating sets have not been changed.

2.2 Turret

221 Where applicable, the following items are to be examined where accessible:

- a) turret and structure around turret
- b) turret bearings and seals
- c) mooring arm pivots and bearings
- d) swivel stack bearing and seals.

SECTION 5

CLASS RENEWAL SURVEY

1 General

1.1

1.1.1 The requirements of this Section apply to class renewal surveys of all units. The specific requirements for class renewal surveys related to service notations and additional class notations assigned to units are addressed in Chapter 4 and Chapter 5, respectively.

1.1.2 (1/7/2015)

The class renewal survey is to include, in addition to the requirements of the annual survey, examination, tests and checks to show that the hull structures, main and auxiliary machinery, systems, equipment and related piping, as required in [2.2.7], are in satisfactory condition or restored to such condition as to allow the unit to operate for the new period of class to be assigned, provided that the unit is properly maintained and operated and other surveys for maintenance of class are duly carried out during this period.

The examinations of the hull are to be supplemented by thickness measurements and testing as required in [2.5.1] and [2.2.7], to ensure that the structural integrity remains effective. The aim of the examination is to discover substantial corrosion, significant deformation, fractures, damages or other structural deterioration.

1.1.3 The Owner is to provide the necessary facilities to enable this class renewal survey. The conditions for survey as detailed in Ch 2, Sec 2, [2.5] to Ch 2, Sec 2, [2.7] are to be met.

1.1.4 When the unit is under the continuous survey system for machinery and/or hull, the scope of the class renewal survey as described in this Section is carried out on a continuous basis over the period of class according to the procedure laid down in Ch 2, Sec 2, [4.3].

When the machinery installation is surveyed under the Planned Maintenance System, a specific program of survey replaces the scope of the class renewal survey of machinery and systems as laid down in [3] below, according to the procedure laid down in Ch 2, Sec 2, [4.4].

1.1.5 A survey-planning meeting is to be held prior to the commencement of the survey.

2 Hull and hull equipment

2.1 Bottom survey

2.1.1 The class renewal survey is to include a bottom survey as laid down in Sec 6, [2.2].

2.2 Decks, hatch covers and equipment

2.2.1 Decks are to be examined, particular attention being given to the areas where stress concentration or increased corrosion are likely to develop, such as hatch corners and other discontinuities of structure.

Deck erections such as hatch coamings, deckhouses and superstructures are to be examined.

The sheathing of wood-sheathed steel decks may be removed, at the Surveyor's discretion, in the case of doubt as to the condition of plating underneath.

Due attention is to be given to the examination in way of end and side openings and related shell and inner doors.

2.2.2 The survey of hull equipment is to cover the following points:

- windlass and chain stoppers, with disassembly as deemed necessary to verify the condition of the equipment and control and safety devices, hawse pipes
- steering arrangements, including steering gear, control and indication devices, operational tests and disassembly as deemed necessary; in the case of chain and rod gears, chains, rods, sheaves, pins and rollers are to be examined for wear
- connection of masts and standing rigging to the hull structure as well as condition of structure underneath
- deck fittings, their pedestals, if any, and the hull structures associated with towing and mooring, with disassembly where applicable and as deemed necessary.

2.2.3 Piping systems outside tanks and compartments are to be visually examined and pressure tested as necessary, as per the requirements laid down for the class renewal survey of machinery and systems; see [3.5].

Ventilators, air pipes, overflow pipes and gas vent pipes, with their means of closure and flame screens, are to be opened up as necessary for the internal examination.

2.2.4 For all units, automatic air pipe heads are to be completely examined (both internally and externally) as indicated in Tab 4.

For designs where the inner parts cannot be properly inspected from outside, this is to include removal of the head from the air pipe. Particular attention is to be paid to the condition of the zinc coating in heads constructed from galvanised steel.

2.2.5 The anchors and chain cables, not pertaining to the mooring system, are to be ranged and examined, and the required complement and condition verified. The chain locker, holdfasts, hawse pipes and chain stoppers are to be examined and pumping arrangements of the chain locker tested. At class renewal surveys of units more than 5 years

of age, chain cables are to be gauged and renewed in cases where their mean diameter is worn below the limits allowed.

2.2.6 The accuracy of the shipboard computer for stability calculations is to be checked by applying all approved test loading conditions. The testing procedure is to be carried out in accordance with Pt B, Ch 11, Sec 2, [4.3.4] of the Rules for the Classification of Ships.

2.2.7 All bilge and ballast piping systems are to be examined and operationally tested to working pressure to the attending Surveyor's satisfaction to ensure that tightness and condition remain satisfactory.

2.3 Holds and other dry compartments

2.3.1 All spaces including holds and their 'tweendecks where fitted, double bottom, deep, ballast, peak and cargo tanks, pump rooms, pipe tunnels, duct keels, machinery spaces, dry spaces, cofferdams and voids are to be internally examined, including the plating and framing, bilges and drain wells, sounding, venting, pumping and drainage arrangements. Internal examination of fuel oil, lube oil and fresh water tanks is to be carried out in accordance with Tab 5.

2.3.2 Machinery and boiler spaces, pump rooms and other spaces containing machinery are to be internally examined, ascertaining the condition of the structure. Particular attention is to be given to tank tops, shell plating in way of tank tops, brackets connecting side shell frames and tank tops, and bulkheads in way of tank tops and bilge wells. Particular attention is also to be given to the sea suction, sea water cooling pipes and overboard discharge valves and their connections to the shell plating. Where wastage is evident or suspected, thickness measurements are to be carried out, and renewals or repairs effected when wastage exceeds allowable limits.

Piping systems inside these spaces are to be dealt with according to [3.5].

2.3.3 Chain lockers are to be cleaned and internally examined, at the second and subsequent class renewal surveys. The pumping arrangement of the chain lockers is to be tested.

2.4 Tanks

2.4.1 The type and number of tanks to be internally examined at each class renewal survey are detailed in Tab 1 for cargo and water ballast tanks and Tab 5 for fuel oil, lubricating oil and fresh water tanks, according to the age of the unit.

This internal examination is to ascertain the condition of the structure, bilges and drain wells, sounding, venting, pumping and drainage arrangements, including piping systems and their fittings. Due attention is to be given to plating or double plates below the lower end of sounding and suction pipes.

Where wastage is evident or suspected, thickness measurements are to be carried out, and renewals or repairs effected when wastage exceeds allowable limits.

Where the inner surface of the tanks is covered with cement or other compositions, the removal of coverings may be waived provided they are examined, found sound and adhering satisfactorily to the steel structures.

Note 1: For examination of independent (non-structural) tanks, refer to [3.5.9].

Note 2: Due attention is also to be given to fuel oil piping passing through ballast tanks, which is to be pressure tested when the unit is more than 10 years old.

2.4.2 Where provided, the condition of corrosion prevention systems of ballast tanks is to be examined. For tanks used for water ballast, excluding double bottom tanks, where a hard protective coating is found in poor condition and it is not renewed, where soft coating has been applied, or where a hard protective coating has not been applied since the time of construction, the tanks in question are to be examined at annual surveys. Thickness measurements are to be carried out as deemed necessary by the Surveyor.

When such breakdown of hard protective coating is found in water ballast double bottom tanks and it is not renewed, where a soft coating has been applied, or where a hard protective coating has not been applied since the time of construction, the tanks in question may be examined at annual surveys. When considered necessary by the Surveyor, or where extensive corrosion exists, thickness measurements are to be carried out.

2.4.3 Boundaries of double bottom, deep, ballast, peak and other tanks, including holds adapted for the carriage of water ballast, are to be tested with a head of liquid to the top of air pipes.

Table 1 : Requirements for internal examination of structural tanks for water ballast and other liquids at class renewal survey

Type and use of structural tanks	Age of unit (in years at time of class renewal survey)			
	age ≤ 5	5 < age ≤ 10	10 < age ≤ 15	age > 15
Peaks (all uses)	all	all	all	all
Salt water ballast tanks (all types)	all	all	all	all
Cargo tanks	all	all	all	all
Note 1: Independent non-structural tanks are to be surveyed according to [3.5.9].				
Note 2: The extent of the survey of tanks dedicated to liquids other than those indicated in this table will be considered by the Society on a case by case basis according to the nature of the liquids.				

2.4.4 Boundaries of fuel oil, lube oil and fresh water tanks are to be tested with a head of liquid to the highest point that liquid will rise to under service conditions. Tank testing of fuel oil, lube oil and fresh water tanks may be specially considered based on a satisfactory external examination of the tank boundaries and confirmation from the Master that pressure testing has been carried out according to the requirements with satisfactory results. The Surveyor may extend the testing as deemed necessary.

2.4.5 Other testing procedures, in particular those specified in Pt B, Ch 12, Sec 3, [2] of the Rules for the Classification of Ships for the initial survey during construction, may be accepted.

2.5 Thickness measurements

2.5.1 Thickness measurements are to be carried out according to the procedure detailed in Ch 2, Sec 2, [2.3].

The extent of thickness measurements is detailed in Tab 2, according to the age of the unit.

The Surveyor may extend the thickness measurements as deemed necessary. When thickness measurements indicate substantial corrosion, the extent of thickness measurements is to be increased to determine areas of substantial corrosion. Tab 3 may be used as guidance for these additional thickness measurements. These extended thickness measurements are to be carried out before the survey is credited as completed.

2.5.2 When the structure is protected with coating and the coating is found to be in good condition, as defined in Ch 2, Sec 2, [2.2.11], the Surveyor may specially consider the extent of thickness measurements in the corresponding areas. Other effective protective arrangements may also be considered.

Table 2 : Requirements for thickness measurements at class renewal survey (1/7/2023)

Age of unit (in years at time of class renewal survey) (1) (2)			
age ≤ 5	5 < age ≤ 10	10 < age ≤15 (4)	age > 15
Suspect areas	Suspect areas	Suspect areas	Suspect areas
	One transverse section of deck plating within 0,5 L amidship (in way of a cargo space, if applicable)	Two transverse sections within 0,5 L amidship (in way of two cargo spaces, if applicable) (3)	A minimum of three transverse sections within 0,5 L amidship (in way of cargo spaces, if applicable) (3)
		Internals in forepeak and after peak tanks	Internals in forepeak and after peak tanks
			All exposed main deck plating full length
			Representative exposed superstructure deck plating (poop, bridge, and forecastle deck)
			Lowest strake and strakes in way of tween decks of all transverse bulkheads in cargo spaces together with internals in way
			All wind and water strakes, port and starboard, full length
			All keel plates full length. Also, additional bottom plates in way of cofferdams, machinery space, and aft end of tanks
			Plating of seachests. Shell plating in way of overboard discharges as considered necessary by the attending Surveyor

- (1) Thickness measurement locations are to be selected to provide the best representative sampling of areas likely to be most exposed to corrosion, considering cargo and ballast history and arrangement and condition of protective coatings.
- (2) Thickness measurements of internals may be specially considered by the Surveyor if the hard protective coating is in GOOD condition.
- (3) For units less than 100 metres in length, the number of transverse sections required at the class renewal survey for units 10 < age ≤15 may be reduced to one, and the number of transverse sections required at subsequent class renewal surveys may be reduced to two
- (4) For units more than 100 metres in length, at the class renewal surveys for units 10 < age ≤15, thickness measurements of exposed deck plating within 0,5 L amidship may be required.

Table 3 : Guidance for additional thickness measurements in way of substantial corrosion areas

Structural member	Extent of measurements	Pattern of measurements
Plating	Suspect area and adjacent plates	5 point pattern over 1 square metre
Stiffeners	Suspect area	3 measurements each in line across web and flange

Table 4 : Survey requirements for automatic air pipe heads at class renewal surveys

Age of unit (in years at time of class renewal survey due date)		
age ≤ 5	5 < age ≤ 10	age >10
<ul style="list-style-type: none"> - Two air pipe heads, one port and one starboard, located on the exposed decks in the forward 0,25 L, preferably air pipes serving ballast tanks. - Two air pipe heads, one port and one starboard, on the exposed decks, serving spaces aft of 0,25 L, preferably air pipes serving ballast tanks. 	<ul style="list-style-type: none"> - All air pipe heads located on the exposed decks in the forward 0,25 L. - At least 20% of air pipe heads on the exposed decks serving spaces aft of 0,25 L, preferably air pipes serving ballast tanks. 	<ul style="list-style-type: none"> - All air pipe heads located on the exposed decks.
See (1) and (2)	See (1) and (2)	See (3)
<p>(1) The selection of air pipe heads to be inspected is left to the attending Surveyor.</p> <p>(2) According to the results of this inspection, the Surveyor may require the inspection of other heads located on the exposed decks.</p> <p>(3) Exemption may be considered for air pipe heads where there is substantiated evidence of replacement within the previous five years.</p>		

Table 5 : Requirements for internal examination of fuel oil, lubricating oil and fresh water tanks at class renewal survey

Type and use of structural tanks	Age of unit (in years at time of class renewal survey)			
	age ≤ 5	5 < age ≤ 10	10 < age ≤ 15	age > 15
Fuel oil - diesel oil tanks (engine room)	none	none	one	one
Fuel oil - diesel oil tanks (cargo length area)	none	one	two	half, minimum two
Lubricating oil tanks	none	none	none	one
Fresh water tanks	none	one	all	all
<p>Note 1: These requirements apply to tanks of integral (structural) type.</p> <p>Note 2: If a selection of tanks is accepted to be examined, then different tanks are to be examined at each class renewal survey, on a rotational basis.</p> <p>Note 3: Peak tanks (all uses) are subject to internal examination at each class renewal survey.</p> <p>Note 4: At class renewal survey no. 3 and subsequent (units older than 10 years), one deep tank for fuel oil in the cargo length area is to be included, if fitted.</p>				

2.6 Turrets and mooring

2.6.1 Turrets

A close-up survey and thickness measurements of structure around external and internal turrets are to be carried out as per the agreed planned survey programme referred to in Ch 2, Sec 2, [2.2.11]. Turret bearings are to be examined in accordance with the manufacturers' recommendations, and agreed survey programme. Records of analyses of turret and swivel bearing seals and lubricants are to be examined by the surveyor for compliance to manufacturers' standards and/or recommendations.

2.6.2 Moorings

Mooring buoys, mooring arms and yokes, mooring towers, and other similar special features of the installation are to

be specially examined in accordance with the agreed planned survey programme referred to in Ch 2, Sec 2, [2.2.11].

2.7 Positional mooring systems

2.7.1 On units fitted with positional mooring equipment the requirements for annual surveys in Sec 3, [3.5.1] are to be complied with.

2.7.2 Where practicable, mooring cables, chains and anchors are to be lifted to the surface for detailed inspection in accordance with [2.7.3] and [2.7.4] at each Special Survey. Alternatively, in situ inspection, using acceptable techniques, will be considered by the Society when requested.

2.7.3 As far as practicable the surveyor is to determine the general condition of the mooring system including cables, chains, fibre ropes, fittings, fairleads, connections and equipment. Particular attention is to be given to the following:

- a) Cable or chain in contact with fairleads, etc.
- b) Cable or chain in way of winches and stoppers.
- c) Cable or chain in way of the splash zone.
- d) Cable or chain in the contact zone of the sea bed.
- e) Damage to mooring system.
- f) Extent of marine growth.
- g) Condition and performance of corrosion protection.

2.7.4 Wire rope anchor cables are to be examined. If cables are found to contain broken, badly corroded or bird caging wires they are to be renewed. Chain cables are to be examined. Maximum acceptable diminution of anchor chain in service will normally be limited to a two per cent reduction from basic chain diameter. (Basic chain diameter can be taken as the diameter, excluding any design corrosion allowance, which satisfies the Rule requirement for minimum factors of safety).

2.7.5 The windlasses or winches are to be examined.

2.7.6 Structure in way of anchor racks and anchor cable fairleads is to be examined.

2.8 Watertight Cable Transits

2.8.1 (1/7/2021)

The requirements for Special Survey may be undertaken by the attending Surveyor or by a firm approved as a service supplier according to Rules for the certification of Service Supplier.

2.8.2 (1/7/2021)

All transits are to be examined to confirm their satisfactory condition and the Register (see Sec 1, [1.1.3]) is to be reviewed to confirm it is being maintained. The Special Survey is to be recorded in the Register, in which a single record entry will be sufficient to record the survey of all transits.

2.8.3 (1/7/2021)

From review of the Register, where there are records entered since the last special survey of any disruption to the cable transits or installation of new cable transits (except which are reviewed and examined at previous annual surveys), the satisfactory condition of those transits, in accordance with the manufacturer's requirements and in accordance with the requirements of type approval, is to be confirmed by the attending Surveyor by review of records and examination of the transits.

It is to be confirmed that, where specified, appropriate specialized tools have been used.

The results are to be recorded in the Register against each of those cable transits.

2.8.4 (1/7/2021)

In case the cable transits have been examined by an approved service supplier, the attending surveyor is to review the Register in order to ascertain that it has been properly maintained by the Shipowner and correctly endorsed by the service supplier.

3 Machinery and systems

3.1 General

3.1.1 The survey items listed below are to be covered to the satisfaction of the Surveyor. However, other survey alternatives deemed equivalent by the Surveyor in relation to the characteristics and general condition of the unit concerned may also be accepted.

Note 1: Attention is drawn to the requirement Ch 2, Sec 2, [2.5.1] regarding safe execution of surveys, in particular as regards health hazards related to asbestos.

3.1.2 Machinery verification runs

At the time of dry-docking, a dock trial is to be carried out to attending Surveyors' satisfaction to confirm satisfactory operation of main and auxiliary machinery. If significant repairs are carried out to main or auxiliary machinery or steering gear, consideration should be given to a sea trial to attending Surveyors' satisfaction.

3.2 Main and auxiliary engines and turbines

3.2.1 General

Depending on the type of machinery, the following parts are to be opened up as necessary for inspection. Parts and

components are to be pressure tested as appropriate or as deemed necessary by the Surveyor. A working test is also to be carried out, including testing of alarms and safety devices.

3.2.2 Internal combustion engines

- a) Columns and entablature
- b) Cylinders with their liners, cylinder covers (together with valves and valve gear), pistons with their rods, crossheads, slippers and guides (or gudgeon pins), connecting rods (with their top and bottom end bearings), control gear, driven scavenge pumps, driven air compressors, driven fuel pumps, supercharging blowers, fuel injection pumps, turning gear, etc.
- c) Crankshafts (together with their main bearings)
- d) Reverse gear, reduction gear and clutches, if fitted.

3.2.3 Steam turbines

- a) Condensers and their cooling water and condensate extraction pumps
- b) Casings and rotors (including their blading), impulse wheels (including guide blading and diaphragms), nozzles and nozzle boxes, journals and bearings, dummy pistons, labyrinths, external glands, etc.
- c) Shafts, including their flexible couplings.

Where the propulsion steam turbines are of a well-known type, and fitted with rotor position indicators and vibration indicators of an approved type, as well as measuring equipment of steam pressure at proper locations along the steam flow, and the arrangements for change-over in the event of emergency operation of the plant are readily operable, the first class renewal survey may be limited to the examination of rotor bearings, thrust bearings and flexible couplings, provided the Surveyor is satisfied from operation service records and power trials subsequent to the survey, that the turbine plant is in good working condition.

3.2.4 Gas turbines

- a) Casings, rotors and disks, impellers and blading of all turbines and compressors, combustion chambers, burners, heat exchangers, gas piping, compressed air piping with fittings, starting and reverse arrangements
- b) Shafts and their flexible couplings.

3.2.5 Electric propulsion

Where the propulsion machinery consists of an electrical system, the propulsion motors, generators, cables and all ancillary electrical gear, exciters and ventilating plant (including coolers) associated therewith are to be examined and the insulation resistance to earth tested. Due attention is to be given to windings, commutations and sliprings. The operation of protective gear and alarm devices is to be checked, as far as practicable. Interlocks intended to prevent unsafe operations or unauthorised access are to be checked to verify that they are functioning correctly.

326 Thruster installations

When the unit is equipped with thruster installations, the class renewal survey is also to include:

- a thorough examination of the machinery and electrical installation, as applicable
- an external examination of the propulsive part of the installation to be carried out at the bottom survey due as part of the class renewal survey. During this examination other checks such as clearance readings, tightness of hub and blade sealing for controllable pitch propellers are to be verified. Locking arrangements for bolts, if fitted, are to be checked. Results of lubricating oil analysis to detect possible deterioration of internal gears and bearings or the presence of water are to be confirmed as acceptable. The Manufacturer's requirements may be taken into account. Dismantling of the assembly for the examination of internal parts may be required if the foregoing checks are not satisfactory
- a running test of the system under operating conditions.

3.3 Reduction gears, main thrust and intermediate shaft(s)

331 Reduction gears complete with all wheels, pinions, shafts, couplings, bearings and gear teeth, including incorporated clutch arrangements, are to be opened up, as deemed necessary by the Surveyor, for visual inspection. For complicated assemblies, gears and roller bearings may be inspected without dismantling.

332 All shafts, thrust blocks and bearings are to be examined.

3.4 Pumps and other machinery items**341 General**

The items listed in [3.4.2] are to be opened up, as deemed necessary by the Surveyor, for visual inspection. Their parts and components are to be pressure tested as appropriate and considered necessary by the Surveyor. A working test is also to be carried out, including testing of alarms and safety devices if deemed necessary by the Surveyor.

342 Items to be surveyed

- a) Air compressors with their intercoolers, filters and/or oil separators and safety devices
- b) Heat exchangers, ventilation fans for boilers and other equipment used for essential services
- c) Piston pumps and centrifugal pumps for sea water, bilge and salt water ballast
- d) Screw pumps, gear pumps and centrifugal pumps other than those listed in c) above (opening up is not required)
- e) Mechanical components used for cooling and maintaining an ambient temperature lower than 45°C (see Pt C, Ch 2, Sec 2, [1.2.2] of the Rules for the Classification of Ships).

3.5 Systems in machinery spaces

351 Valves, cocks and strainers of the bilge and ballast systems are to be opened up, thoroughly or partly as

deemed necessary by the Surveyor, for visual inspection, and, together with the piping and safety devices, examined and tested under working conditions.

352 The fuel oil, lubricating oil, hydraulic oil, thermal oil, and feed and cooling water systems, together with pressure filters, heaters and coolers used for essential services, are to be opened up and examined or tested, as considered necessary by the Surveyor. Safety devices for the foregoing items are to be examined.

353 The compressed air system together with its valves, fittings and safety devices is to be examined, as considered necessary by the Surveyor.

354 Compressed air receivers and other pressure vessels for essential services are to be cleaned internally and examined internally and externally. Where the above receivers or vessels cannot be examined internally, they are to be hydrostatically tested to 1,5 times the working pressure. Their fittings, valves and safety devices are to be opened up, as deemed necessary by the Surveyor, for visual inspection and pressure tested as appropriate.

355 Steel pipes for superheated steam having a temperature of the steam at the superheater outlet exceeding 450°C are to be examined and tested in accordance with [3.5.7] to [3.5.8] at each class renewal survey.

356 Steel pipes for saturated steam or superheated steam having a temperature of the steam at the superheater outlet not exceeding 450°C are to be examined and tested in accordance with [3.5.7] to [3.5.8] at each class renewal survey for units over 5 years of age. When the unit is 5 years of age or less, the inspection may be limited to a check of the satisfactory general condition of pipes.

357 The examination and hydrostatic test of steel pipes for main steam machinery, and steel pipes for auxiliary steam machinery having internal diameter 75 mm and over, are to be carried out on a number of pipes selected by the Surveyor after the lagging in way is removed.

358 Representative pipe lengths connected with bolted flanges are to be internally and externally examined, and hydrostatically tested to 1,1 times the working pressure at ambient temperature. Bolts and butt-welded joints between flanges and pipes are to be submitted to a non-destructive test for crack detection.

359 Non-structural tanks located in machinery spaces are to be externally examined; the relevant fittings, with particular regard to the remote control shut-off valves under hydrostatic head, are to be externally examined to check the efficiency of manoeuvres and the absence of cracks or leakage.

3510 When the unit is equipped with a refrigerating plant (whether or not covered by an additional class notation), the class renewal survey is to include:

- examination and test at the design pressure of the parts of the plant under pressure

- for refrigerating machinery spaces using ammonia as refrigerant:
 - examination of valves and pumps of the bilge system to the same extent as indicated in [3.4]
 - examination and test of the electrical equipment to the same extent as indicated in [3.6.10]
 - test of the gas detection system.

3.6 Electrical equipment and installations

3.6.1 An electrical insulation resistance test is to be performed on the electrical equipment and cables. If needed, for the purpose of this test, the installation may be subdivided or equipment which may be damaged disconnected.

3.6.2 The prime movers of generators are to be surveyed in accordance with [3.2] and their governors tested. All generators are to be presented for inspection, clean and with covers opened and examined under working conditions.

3.6.3 Main and emergency switchboards, section boards and distribution boards are to be cleaned and doors or covers opened for examination of their fittings. The condition of overcurrent protective devices and fuses is to be checked. Circuit-breakers of generators are to be tested, as far as practicable, to verify that protective devices including preference tripping relays, if fitted, operate satisfactorily. The tightening of busbar connections is to be checked.

3.6.4 Electrical cables and cable runs are to be examined at random, in particular in places where deterioration is likely to occur; terminal boxes of essential services are also to be subjected to a random check.

3.6.5 The motors and starters concerning essential services together with associated control and switchgear, including electrical components used for cooling and maintaining an ambient temperature lower than 45°C (see Pt C, Ch 2, Sec 2, [1.2.2] of the Rules for the Classification of Ships), are to be examined and, if considered necessary by the Surveyor, checked, as far as practicable, under working conditions.

3.6.6 Navigation light indicators are to be tested under working conditions, and correct operation on the failure of supply or failure of navigation lights verified.

3.6.7 The emergency sources of electrical power, their automatic arrangements and associated circuits are to be tested.

3.6.8 Emergency lighting, transitional emergency lighting, supplementary emergency lighting, general emergency alarm and public address systems are to be tested as far as practicable.

3.6.9 The visible condition of electrical equipment and installations is also to be checked as regards precautions against shock, fire and other hazards of electrical origin.

3.6.10 A general examination of the electrical equipment in areas where there may be flammable gas or vapour and/or combustible dust is to be carried out to ensure that the integrity of the electrical equipment of a safety type has not been impaired owing to corrosion, missing bolts, etc., and that there is not an excessive build-up of dust on or in dust-protected electrical equipment. Cable runs are to be examined for sheath and armouring defects, where practicable, and to ensure that the means of supporting the cables are in satisfactory condition. The proper condition of

bonding straps for the control of static electricity is to be checked. Alarms and interlocks associated with pressurised equipment or spaces are to be tested for correct operation.

Note 1: Owners are reminded that maintenance, repairs or renewal of certified electrical equipment of a safe type remains their responsibility or that of their representatives.

3.7 Controls

3.7.1 Where remote and/or automatic controls, not covered by an additional class notation related to automated installation, are fitted for essential machinery, they are to be tested to demonstrate that they are in satisfactory condition.

3.8 Fire protection, detection and extinction

3.8.1 The class renewal survey of fire prevention arrangements consists of the test of the fire and/or smoke detection and alarm systems.

3.8.2 The survey requirements for fixed low pressure CO₂ fire-extinguishing systems fitted on board are the following.

Receivers of CO₂ fixed fire-extinguishing systems are to be externally examined together with all stationary fittings and devices. In addition CO₂ containers are to be internally inspected if the content has been released and the container is older than five years. Depending upon the result of the internal examination, the Surveyor may require the container to be hydrostatically tested.

It is to be checked that the distribution pipework is proved clear.

4 Import/Export systems

4.1

4.1.1 The class renewal survey is to include all items listed under the annual survey and, in addition, the following is to be performed.

- a) Fluid and electrical swivels are to be disassembled, if considered necessary, and examined for wear and tear. The seals are to be examined. Upon completion of the reconditioning, the fluid swivels are to be hydrostatically tested. Similarly, the electrical swivels are to be insulation tested upon reassembly.
- b) During underwater inspection of the SPM system, flexible risers are to be examined, including all arch-support buoyancy tanks. Risers are to be inspected for damage in high stress areas, such as areas in way of the end flanges, areas in way of the arch support clamps and the bottom of all looped areas. Spreader bars, if fitted, to separate one riser string from another, are to be inspected for wear and tear. Hydrostatic tests may be required to be conducted on the risers, as deemed necessary by the attending Surveyor. For deep sea applications, riser suspension or support systems are to be examined for deterioration and loss of tension. Support areas in way of the riser are to be closely examined for fretting corrosion, wear, kinks, creases, etc.

- c) Floating export hoses are to be examined for kinks, surface cracks, chaffing damages, etc. Hydrostatic and vacuum tests may be required to be conducted on the floating hose string, as deemed necessary by the attending Surveyor.
- d) All piping systems are to be opened up for examination. Nondestructive and hydrostatic tests may be considered necessary where required by the attending surveyor.
- e) For disconnectable type mooring systems, the connecting and disconnecting arrangements for the

import and export systems are to be tested, as considered necessary by the attending Surveyor. Alternatively, records of disconnecting/connecting operations between the credit date of the last class renewal survey and the current due date of same may be reviewed, and if found satisfactory, it may be considered to have complied with this requirement.

SECTION 6

BOTTOM SURVEY

1 General

1.1

1.1.1 The bottom survey may be carried out in dry condition, such as in dry dock or on a slipway, or through an in-water survey.

The conditions for acceptance of a bottom in-water survey in lieu of a bottom survey in dry condition are laid down in Ch 2, Sec 2, [5.4.4] and [3].

2 Bottom survey in dry condition

2.1 General requirements

2.1.1 When a unit is in dry condition, it is to be placed on blocks of sufficient height and with the necessary staging to permit the examination of elements such as shell plating including bottom and bow plating, stern frame and rudder, sea chests and valves, propeller, etc.

2.1.2 The outer shell plating is to be visually examined for excessive corrosion, or deterioration due to chafing or contact with the ground or for any undue deformation or buckling. Due attention is to be given to the plating of end structures (stem and sternframe), and to the connection between the bilge strakes and the bilge keels. Significant plate unevenness or other deterioration which does not necessitate immediate repairs is to be recorded.

2.1.3 Sea chests and their gratings, sea connections and overboard discharge valves and cocks and their fastenings to the hull or sea chests are to be examined. Valves and cocks need not be opened up more than once in a class renewal survey period unless considered necessary by the Surveyor.

2.1.4 Visible parts of the propeller(s), stern bush(es), propeller shaft boss, brackets and tightness system(s) are to be examined. The clearances of the propeller shaft(s) (or wear down gauge) are to be checked and recorded. For controllable pitch propellers, the Surveyor is to be satisfied with the fastenings and tightness of hub and blade sealing.

Visible parts of other propulsion systems and propellers for steering purposes are also to be examined.

Dismantling is to be carried out, if considered necessary, notably where leakages are detected.

2.1.5 Visible parts of the rudder(s), rudder pintles, rudder stock and couplings as well as the sternframe are to be examined. If considered necessary by the Surveyor, the rudder(s) is (are) to be lifted or the inspection plates removed for the examination of pintles.

The clearances in the rudder bearings and the rudder lowering are to be checked and recorded.

Where applicable, a pressure test of the rudder may be required as deemed necessary by the Surveyor.

2.2 Bottom survey held within the scope of class renewal survey

2.2.1 The bottom survey held within the scope of the class renewal survey is to be carried out in compliance with [1.1].

3 Bottom in-water survey

3.1 General

3.1.1 An in-water survey may normally be carried out if the unit has been granted the additional class notation **INWATERSURVEY** as defined in Ch 1, Sec 2, [6.10.1]. Upon application by the Owner and in special circumstances, the Society may also authorise such bottom in-water survey for units not assigned with the additional class notation **INWATERSURVEY**.

3.1.2 The bottom in-water survey is to provide the information normally obtained from a bottom survey carried out in dry condition. Special consideration is to be given to ascertaining rudder bearing clearances and stern bush clearances of oil stern bearings based on a review of the operating history, on board testing and stern oil sample reports. These considerations are to be included in the proposals for in-water survey, which are to be submitted in advance of the survey so that satisfactory arrangements can be agreed on with the Society.

3.1.3 The in-water survey is to be carried out with the unit at a light draught in sheltered water and preferably with weak tidal streams and currents. The in-water visibility is to be good and the hull below the waterline is to be sufficiently clean to permit meaningful examination.

The Society is to be satisfied with the methods of localisation of the divers on the plating, which should make use where necessary of permanent markings on the plating at selected points.

The equipment and the procedure for observing and reporting the survey are to be discussed with the parties involved prior to the in-water survey, and suitable time is to be allowed to permit the diving company to test all equipment beforehand.

3.1.4 The in-water survey is to be carried out by one or more professional divers in the presence of a Surveyor. The diver(s) is (are) to be employed by a firm agreed by the Society.

For the agreement of such firms, refer to Ch 2, Sec 2, [2.4].

3.1.5 The Surveyor is to be satisfied with the method of pictorial representation, and good two-way communication between the Surveyor and the divers is to be provided.

3.1.6 If the in-water survey reveals damage or deterioration that requires early attention, the Surveyor may require the unit to be drydocked in order for a detailed survey to be undertaken and the necessary repairs carried out.

SECTION 7

SHAFT SURVEY

1 Survey of shafts

1.1 General

1.1.1 (1/7/2015)

For ship-type units fitted with shaft(s), reference is to be made to the rule requirements given in Ch 3, Sec 7, [1] of the Rules for Classification of Ships.

2 Periodical survey of other propulsion systems

2.1 Rotating and azimuth thrusters

2.1.1 (1/7/2014)

The periodical survey of rotating and azimuth thrusters consists of:

- a) removing the propeller(s) in order to examine the following items, as applicable:
 - exposed parts
 - cone and keyway to be checked by an appropriate crack detection method
 - sealing glands
 - threaded end and nut.

For keyless or flange mounted propellers, alternative means to removal of the propeller for examination of the shaft cone, such as pressure testing of the hub and hub gland, may be adopted at alternate surveys;

- b) examining the results of a lubricating oil analysis (water content and presence of material particles) to detect

possible deterioration of internal gears and bearings c) examining the orientation device.

If the foregoing checks are not satisfactory, dismantling of the internal parts may be required.

2.2 Vertical axis propellers

2.2.1 (1/7/2014)

The periodical survey of vertical axis propeller systems consists of:

- checking the tightness of the oil glands and the backlash of the gears from outside by action on the blades
- checking the condition of gears and couplings from inside the ship
- examining the results of a lubricating oil analysis (water content and presence of material particles) to detect possible deterioration of internal gears and bearings.

If the foregoing checks are not satisfactory, dismantling of the internal parts may be required.

2.3 Pump jet systems

2.3.1 (1/7/2014)

The periodical survey of pump jet systems consists of examining the following parts:

- impeller, shaft and clearances of bearings
- tightness of gland
- water duct
- steering nozzle
- reversing arrangements and control gear.

If the foregoing checks are not satisfactory, further dismantling may be required.

SECTION 8

BOILER SURVEY

1 Steam boilers

1.1

2.31 Steam boilers, superheaters and economisers are to be examined internally and externally with the periodicity given in Ch 2, Sec 2, [5.6]. To this end, boilers are to be emptied and suitably prepared for the examination, and the water-steam side and fire side are to be cleaned and cleared of soot. Where necessary, the external surfaces are to be made accessible for inspection by removal of insulation and lining.

The internal examination is to be made on both the water-steam side and fireside.

Review of the following records since the last boiler survey is to be carried out as part of the survey:

- Operation
- Maintenance
- Repair history
- Feed water chemistry.

2.32 Subject to the results of this visual examination, the Surveyor may require:

- non-destructive tests for detection of possible defects in critical areas of plating and shells, pipes and stays
- thickness measurements of plating and shells, furnaces, pipes and stays.

If appropriate, a new working pressure may be fixed by the Society.

When situated inside boiler combustion chambers, steam pipes of cylindrical boilers are to be examined at their ends, and if deemed necessary by the Surveyor, a sample pipe is to be removed for examination.

2.33 If the internal examination is not carried out for practicable reasons, the parts subject to pressure are to be submitted to a hydraulic test.

2.34 Boiler supports and securing arrangements (fixed and sliding seating, chocks, rolling stays, if any, etc.) are to be examined.

Boiler accessories and mountings (such as valves and studs, water level indicators, safety valves) are to be externally and (as needed) internally examined.

Forced circulation pumps of fired steam generators are, wherever possible, to be opened up.

Fuel supply pipes between pumps and burners, fuel tank valves, pipes and deck control gear are to be examined.

2.35 Upon completion of the internal survey, the boiler is to be examined under steam and fuel oil burners and safety devices checked under working conditions.

The boiler safety valves and their relieving gear are to be examined and tested to verify satisfactory operation. However, for exhaust gas heated economisers, if steam cannot be raised at port, the safety valves may be set by the Chief Engineer at sea, and the results recorded in the log-book for review by the Society.

2.36 When an extension of the interval of the boiler survey is granted based on Ch 2, Sec 2, [5.6.3], the following is to be satisfactorily carried out:

- a) External examination of the boiler
- b) Boiler safety valve relieving gear (easing gear) is to be examined and operationally tested
- c) Boiler protective devices operationally tested
- d) Review of the following records since the last boiler survey:
 - Operation
 - Maintenance
 - Repair history
 - Feed water chemistry.

2.37 In addition to the other requirements of [1.1.1] (internal examination), in exhaust gas heated economisers of the shell type all accessible welded joints are to be subjected to a visual examination for cracking. Non-destructive testing may be required for this purpose

2 Thermal oil heaters

2.1

2.1.1 Thermal oil heaters are to be internally and externally examined. The heater tubes are to be visually examined, and the tightness of the installation (including flange connections, valves and pumps) is to be checked through a test at the working pressure.

2.1.2 Thermal oil heater supports and securing arrangements are to be examined.

Heater accessories and mountings are to be externally and (as needed) internally examined.

Forced circulation pumps are, wherever possible, to be opened up.

Fuel supply pipes between pumps and burners, fuel tank valves, pipes and deck control gear are to be examined.

2.1.3 The following safety devices and instrumentation are to be examined and tested:

- thermal fluid temperature safety device and control
- thermal fluid flow meter
- device for low thermal fluid level in the expansion tank
- other regulation and safety systems.

2.1.4 Where repairs and/or renewal of components exposed to pressure are performed, a pressure test is to be carried out to 1,5 times the working pressure

2.1.5 Upon completion of the survey, the thermal oil heater is to be examined under working conditions, with particular attention to safety devices and controls of the plant.

APPENDIX 1 CLASS REQUIREMENTS AND SURVEYS OF LAID-UP UNITS

1 General

1.1

1.1.1 In order to maintain its class during a normal operation period, a unit is to be submitted to the surveys described in Ch 2, Sec 2 at their due dates and to the satisfaction of the Society, and is to be free of overdue surveys and conditions of class during the considered period.

1.1.2 When a unit stops trading and is put out of commission for a certain period, i.e. is laid-up, the normal survey requirements may no longer apply provided that the Owner notifies the Society of this fact. The Owner is also to submit a lay-up maintenance program to the Society for approval.

1.1.3 The lay-up maintenance program includes:

- the safety conditions to be kept throughout the lay-up period
- the measures taken to preserve the maintenance of the unit throughout the lay-up period
- the survey requirements to be complied with for lay-up, maintenance of class in lay-up and re-commissioning.

2 Safety conditions

2.1

2.1.1 Power supply

Adequate power supply is to be supplied, or readily available, all around the clock, either from independent means on board the unit or from shore.

The following safety conditions are to be kept throughout the lay-up period.

2.1.2 Manning

Watch personnel are to be provided. The number of the watch personnel will depend on the size of the unit, the lay-up site and mooring arrangements, the shore assistance available in case of fire, leakage or flooding, the maintenance required to provide adequate preservation. A permanent shore communication installation (radio, telephone) is also to be available.

2.1.3 Fire protection and fire fighting

The following is to be complied with:

- automatic fire alarm systems, where provided, are to be in working order and in operation
- low pressure CO₂ fire-extinguishing systems, if fitted, are to be tested regularly and readily available.

2.1.4 Protection against explosion

Cargo spaces and piping systems are to be cleaned and ventilated to prevent gas from forming any pockets.

An inert gas system in operation is recommended for the cargo spaces of all units.

All flammable materials, sludge, etc. are to be removed from the unit's bilge, tank tops, double bottom tanks, engine room, pump rooms and similar spaces.

Hot work is not to be carried out during lay-up, unless special precautionary measures are taken.

2.1.5 Safety equipment

All the equipment usually recommended for the safety of the watch personnel is to be provided, kept in working order and tested regularly.

The usual life-saving equipment such as life rafts, life-buoys, breathing apparatus, oxygen masks and distress signals is to be provided and made accessible.

The requirements of the flag Administration and of the local port authorities of the lay-up site are usually to be applied.

2.1.6 Emergency power

The emergency source of power, emergency generator and/or emergency air compressor are to be kept in working order and tested weekly.

3 Preservation measures for lay-up and maintenance

3.1 General

3.1.1 A lay-up log-book is to be kept on board, in which the maintenance work and tests carried out during the lay-up period are to be entered with the corresponding dates. The nature and frequency of the maintenance, inspections and tests are also to be defined in the lay-up log book.

3.1.2 The following measures for preservation and maintenance during the lay-up period are to be taken by Owners according to the type of unit, hull equipment, machinery installations and the specific cases of lay-up conditions.

3.2 Exposed parts of the hull

3.2.1 Underwater parts of the hull are to be protected against corrosion. It is advisable to provide an impressed current cathodic protection system where the quantity of corrosive waste discharge is particularly high. When such systems are provided they are to be serviced and checked at regular intervals. The condition of sacrificial anodes is to be evaluated at the annual lay-up condition surveys.

3.2.2 The coating of the hull above the waterline, exposed decks, access doors or covers on exposed decks, and hatch covers is to be maintained in satisfactory condition.

All accesses leading to internal spaces are to be kept closed.

All vent pipes and ventilation trunks are to be kept closed.

3.3 Internal spaces

3.3.1 Cargo tanks are to be emptied, cleaned and kept dry.

Ballast tanks are to be kept either full or empty. When ballast spaces are kept filled with sea water, special care is to be taken to keep such spaces topped up and protected against corrosion. When provided, sacrificial anodes are to be renewed when deemed necessary. The topping up is to be regularly verified.

3.3.2 Chain lockers are to be drained, cleaned and kept dry. Coating with bituminous paint is recommended.

3.3.3 Fuel oil and lubricating oil tanks are to be drained regularly.

Lubricating oil analysis is to be performed regularly and the oil renewed when the result is not satisfactory. Prior to being refilled, tanks are to be cleaned.

Empty lubricating oil tanks are to be cleaned and kept dry.

Fresh water or distilled water tanks are to be kept full or empty. Empty tanks are to be cleaned and kept dry. Where cement wash is used as a coating, this is to be examined and, if necessary, repaired prior to filling.

3.3.4 The bilge and tank top in engine rooms are to be cleaned and kept dry.

Hull sea inlet and outlet valves not in use are to be kept closed.

3.4 Deck fittings

3.4.1 The windlass, capstans and winches are to be regularly greased and turned once a week.

All wire cables are to be kept greased.

Visible parts of chains are to be coal-tarred and examined regularly.

Chocks and hawse pipes are to be coated with bituminous paint or equivalent if deemed necessary.

Cargo piping on deck is to be drained, blown through if deemed necessary and kept dry by opening up drains.

Electrical machinery and navigational equipment are to be protected by watertight covers.

3.5 Machinery

3.5.1 Machinery spaces

The air temperature inside the machinery spaces is normally to be kept above 0°C.

Humidity is to be kept as low as possible and within acceptable limits.

3.5.2 Machinery - General

Exposed mechanical parts of machinery are to be greased.

All rotating machinery such as diesel engines, reciprocating engines, pumps, turbines, electric motors and generators are to be turned at regular intervals with a limited number of revolutions (the lubricating oil system should be put in operation or proper priming applied). Units are not to be stopped in the same position as the previous one.

Bearing boxes are to be emptied, cleaned and refilled with new oil.

3.5.3 Turbines

Turbines are to be kept dry.

All steam inlets are to be sealed.

Expansion arrangements (sliding feet) are to be suitably greased.

Electric heaters are to be put inside the turbines. Heat drying is to be made in open circuit, all valves shut and gland closing devices withdrawn.

Turbines are to be turned weekly, the lubricating oil system being put in service. The shaft line is to be stopped after turning an integer number of revolutions plus one quarter of a revolution.

3.5.4 Reduction gears

For large reduction gears, a fan activating the circulation of hot air in closed circuit with air hoses is to be fitted (intake at lower part of casing and discharge at upper part).

3.5.5 Auxiliary turbine-driven machinery

Stators are to be drained and kept dry.

Shaft sealing glands are to be lubricated.

Lubricating oil is to be analysed and renewed when deemed necessary. Prior to oil renewal, the oil casings are to be cleaned.

Exhaust steam pipes are to be kept dry.

Stuffing boxes are to be dismantled.

Turbines are to be turned weekly an integer number of revolutions plus one quarter of a revolution.

3.5.6 Condensers and heat exchangers

Condensers and heat exchangers are to be drained and kept dry.

Desiccant is to be placed in steam spaces.

Water sides are to be washed with fresh water.

The condition of the zinc anodes is to be periodically checked.

When tubes are fitted with plastic or fibre packing, water sides are to be filled with alkaline distilled water.

When tubes are expanded or fitted with metal packing, water sides are to be provided with desiccants and kept dry.

3.5.7 Auxiliary machinery

Air receivers are to be drained, opened up and cleaned. Pressure relief valves are to be cleaned and slightly lubricated.

Air compressor crankcases are to be drained, cleaned and refilled with clean oil. Cylinders and valves are to be lubricated. Coolers are to be drained and dried. Air drains are to be opened and the system dried.

Air start lines are to be drained and dried.

Hot-wells/return tanks are to be drained and dried.

De-aerators are to be drained and dried.

Feed pumps and extraction pumps are to be drained and dried.

Air ejectors are to be drained and dried.

Main circulation pumps are to be drained and dried.

Evaporators are to be drained, cleaned and dried.

3.5.8 Piping

Pipes not in use are to be drained and kept dry.

3.5.9 Diesel engines

Daily tank fuel oil outlet pipes and all injection equipment are to be filled with filtered gas oil.

Fresh water circuits are to be filled with water mixed with rust inhibitors. Fresh water pH is to be checked monthly.

Oil of hydraulic regulators is to be replaced.

Sea water cooling pipes are to be drained.

Crankcases are to be provided with desiccant.

Starting valves are to be lubricated (internally and externally).

Motor oil is to be sprayed in cylinders and on all external parts liable to corrosion.

Cams and cylinders are to be motor oil sprayed monthly.

Turbo-compressor/charger ball bearings are to be oil sprayed and rotated for an integer number of revolutions plus one quarter of a revolution.

Engine air inlets and exhaust gas pipes are to be sealed.

Scavenge spaces are to be cleaned

Engines are to be turned weekly.

3.5.10 Shaft lines

Shaft lines are to be coated with grease.

Shaft bearing cooling pipes are to be drained.

3.6 Electrical installations

3.6.1 Main and secondary switchboards, sub-feeder panels, fuse panels and starters are to be made tight. Desiccant is to be provided.

Contacts of relays, breakers and switch-breakers are to be coated with neutral vaseline.

Bearings of generators are to be cleaned of old grease and protected with new oil or grease.

Carbon brushes are to be lifted off their commutations.

3.6.2 Electrical insulation of each item is to be kept at a minimum 200000 \wedge and general insulation is to be not less than 50000 \wedge . Local electric heating may be necessary to improve the level of insulation, particularly in the generators/alternators and large motors.

A megger test is to be performed regularly.

3.7 Steering gear

3.7.1 Exposed mechanical parts are to be greased or oil sprayed.

For electrical parts the same preservation measures given in [3.6] are to be taken.

It is recommended that the steering gear should be operated monthly.

3.8 Boilers

3.8.1 Smoke sides of boilers are to be swept, washed clean with basic hot water and hot air dried.

3.8.2 Water and steam sides should preferably be preserved using the dry method, keeping the moisture at the lowest possible level, the ideal level being between 30% and 35%. It is advisable to ensure that no residual water remains to cause rapid corrosion. Drum doors are to be kept closed.

In other cases, it is advisable to keep the boilers, superheaters and economisers filled with water having a pH around 10.5. Hydrazine hydrate treatment of the water is preferable to reduce risks of corrosion caused by dissolved oxygen. The water is to be regularly analysed.

3.8.3 Air heaters are to be cleaned and kept dry.

Uptake, shell and fan outlets are to be cleaned and kept closed with watertight hoods.

Burners are to be dismantled, and atomisers greased.

Desiccant is to be provided in furnaces where deemed necessary.

Expansion arrangements (sliding feet) are to be suitably greased.

The internal condition of boilers is to be checked every three months.

3.8.4 Boilers may also be preserved sealed with inert gas (nitrogen), provided that cocks and valves are tight and the installation allows an internal pressure of at least 0,05 bar to be maintained to prevent air penetration. Regular checks of the overpressure are to be carried out and results recorded in the log-book.

3.9 Automation equipment

3.9.1 Recommendations for electronic components are the same as those given for electrical installations.

For pneumatic parts the manufacturers' recommendations are to be followed and the system is to be checked regularly.

Pressure, temperature or level sensors are generally not affected by damage when not used. However, when available, the manufacturers' recommendations are to be followed.

3.10 Mooring system

3.10.1 For units as FSO or FPSO or FSRU, provided with a mooring system the same shall be maintained according to the lay-up site as follows:

- a) If lay-up is performed with the unit moored in its operating area, the mooring system is to be in working order and in operation.
- b) If lay-up is performed by shifting the unit to a lay-up site (see [4]), the exposed mechanical parts are to be greased or oil sprayed. For electrical parts the same preservation measures given in [3.6] are to be taken. Manufacturer instructions, if any, should be strictly applied.

4 Lay-up site and mooring arrangements**4.1 General**

411 The choice and suitability of the lay-up site, as well as the type of mooring conditions, the mooring arrangements and their efficiency during the lay-up period remain the responsibility of the Owner.

However, at the Owner's request, the mooring arrangement may be reviewed by the Society.

412 For units as FSO or FPSO or FSRU the lay up site may be the operating site with the unit moored as per normal operating condition.

4.2 Recommendations for the lay-up site

421 The following recommendations are to be considered by Owners regarding the choice and suitability of the lay-up site when the condition in [4.1.1] occurs.

The site should be:

- sheltered from open sea, strong currents and waves
- not exposed to whirling winds or turbulent tidal waves
- not exposed to moving ice
- clear of corrosive waste waters
- provided with adequate ship/shore communications.

4.3 Recommendations for the mooring arrangements

431 The following recommendations are to be considered by Owners with respect to the mooring arrangements:

- ground holding should be adequate
- vessels laid-up to buoys or anchored should be moored in such a way as to be prevented from swinging with normal wind and tidal changes
- chain cables should not be subject to cross-contact or twisting and stern anchorage should generally be provided
- laid-up units should be in ballast condition in order to reduce the effects of wind. Due consideration should be given to the still water bending moment. For guidance, normal ballast draft should be roughly between 30% and 50% of the maximum draft.

432 Units should normally be moored singly. However, when several units are moored together, the following provisions are to be made:

- units are to be moored bow to stern
- units are to be of approximately the same size
- the number of units moored together is, in principle, not to exceed six
- breast-lines are to be of similar elasticity
- fenders are to be provided.

4.4 Review of the mooring arrangements

441 As indicated in [4.1.1], at the Owners' request, the mooring arrangements may be reviewed by the Society.

442 The proposal for the mooring arrangements is in such case to be submitted by the Owner and is to include the following information.

- a) Mooring site:
 - geographical area (to be specified on a map)
 - characteristics of the sea bottom
 - water depth
 - preferential angular sectors (effects of wind / tide / current) indicated according to statistical studies
 - wave characteristics (amplitude, periods)

- b) Geometry of mooring arrangements:
- unit's position and direction
 - shore anchorage
 - diagram showing mooring equipment (fore and aft)
 - angle between chain cables and unit's centreline
- c) Characteristics of mooring equipment:
- maximum holding strength of each anchor
 - type of mooring lines (chains, cables, sinkers, etc.)
 - length of each section
 - weight of each section
 - mechanical characteristics of each section (breaking load)
 - weight of sinkers.

443 On completion of the installation, the mooring arrangements are to be inspected by the Society. When the unit is anchored, the underwater installation is to be inspected by a diver whose report is to be presented to the Society.

444 It is the responsibility of the Owners to ascertain the efficiency of the mooring arrangements during the lay-up period. The mooring arrangements are to be re-examined at regular intervals (at least each year when the unit is anchored) and when abnormal weather conditions occur at the lay-up site.

5 Surveys

5.1 Laying-up survey

511 At the beginning of the lay-up period a laying-up survey is to be carried out whose scope is to verify that the safety conditions, preservation measures, lay-up site and mooring arrangements are in accordance with the program agreed by the Society.

512 Upon satisfactory completion of this survey, an endorsement to confirm that the unit has been placed in lay-up is entered on the Certificate of Classification, which is subsequently to be kept on board.

5.2 Annual lay-up condition survey

521 As described in Ch 2, Sec 2, [8], an annual lay-up condition survey is to be performed in lieu of the normal annual class surveys. The purpose of this survey is to ascertain that the lay-up maintenance program implemented is continuously complied with.

522 It is to be checked that the arrangements made for the lay-up are unchanged and that the maintenance work and tests are carried out in accordance with the maintenance manual and recorded in the lay-up log-book.

523 Upon satisfactory completion of the survey, the Certificate of Classification is endorsed.

5.3 Re-commissioning survey

531 Owners are to make the necessary arrangements to remove the temporary lay-up installations provided for preservation measures and the protective materials and coatings (oil, grease, inhibitors, desiccants), before the survey is commenced.

It is the Owners' responsibility to verify that the unit parts that are not covered by class are reactivated in satisfactory operational condition.

532 The scope of the re-commissioning survey is to include:

- a general examination of the hull, deck fittings, safety systems, machinery installations (including boilers whose survey is not due) and steering gear
- all periodical surveys due at the date of re-commissioning or which became overdue during the lay-up period
- dealing with the recommendations due at the date of re-commissioning or which became due during the lay-up period.

533 For the hull the following is to be carried out:

- examination of shell plating above the waterline, deck plating
- examination of load line items
- overall survey of all cargotanks
- overall survey of representative ballast tanks when the lay-up period does not exceed two years
- overall survey of all ballast tanks when the lay-up period is two years and over
- function tests of bilge and ballast systems.

534 For the deck fittings the following is to be carried out:

- where possible, examination of deck piping under working pressure
- function tests of class items
- checking inert gas installation under working condition after inspection of water seal and function test of deck non-return valve and pressure/vacuum valves.

535 For machinery installations the following is to be checked:

- the analysis of lubricating oil of main engines, auxiliary engines, reduction gears and main thrust bearings
- the general condition of crankcase, crankshaft, piston rods and connecting rods of diesel engines
- the crankshaft deflections of diesel engines. In addition when engines have been laid-up for more than two years, one piston is to be disconnected and one liner is

to be removed for examination. Dismantling is to be extended if deemed necessary

- the condition of blades of turbines through the inspection doors
- the condition of the water side of condensers and heat exchangers
- the condition of expansion arrangements
- the condition of reduction gears through the inspection doors
- the condition after overhauling of pressure relief devices
- the test of bilge level alarms, when fitted.

536 The main and emergency electrical installations are to be tested. The parallel shedding of main generators and main switchboard safety devices are to be checked. A megger test of the electrical installation is to be performed.

537 For the fire prevention, detection and fire-fighting systems, the following is to be examined and/or tested:

- fire detectors and alarms
- low pressure CO₂ fire-extinguishing systems, if fitted.

538 The automated installation is to be checked for proper operation.

539 For cargo installations on FSRU, the following is to be carried out:

- inspection of the primary barrier in tanks
- for membrane tanks, a global gas test of tanks whose results are to be compared with those obtained at unit's delivery
- testing of gas piping at working pressure using inert gas.

A Surveyor of the Society is to attend the first cooling down and loading of the unit.

5310 For other specific classed installations, the Owners are to submit a survey program to the Society.

5311 On completion of the above surveys and tests, sea trials or function tests, as applicable, are to be performed in the presence of a Surveyor of the Society.

The sea trials or function tests are to include :

- verification of the satisfactory performance of the deck installations, main propulsion system and essential auxiliaries, including a test of the safety devices
- an anchoring test
- complete tests of steering gear
- full head and full astern tests
- tests of automated machinery systems, where applicable

5312 Upon satisfactory completion of the surveys, an endorsement to confirm the carrying out of all relevant surveys and the re-commissioning of the unit is entered on the Certificate of Classification.

Part A
Classification and Surveys

Chapter 4

**SCOPE OF SURVEYS IN RESPECT OF THE
DIFFERENT SERVICES OF UNITS**

SECTION 1	GENERAL
SECTION 2	FSO AND MOSU
SECTION 3	FPSO AND FPU
SECTION 4	FSRU
SECTION 5	MODU
SECTION 6	FLNG
SECTION 7	SPECIAL SERVICE

SECTION 1

GENERAL

1 General

1.1

1.1.1 The purpose of this Chapter is to give details on the scope of surveys of certain units which, due to the service notation assigned and related equipment, need specific requirements to be verified for the maintenance of their class.

1.1.2 These specific requirements either are additional to or supersede those stipulated in Chapter 3, which gives general requirements for surveys applicable to all types of units: this is indicated in each Section of this Chapter. These surveys are to be carried out at intervals as described in Ch 2, Sec 2, concurrently with the surveys of the same type, i.e. annual, intermediate or class renewal surveys, detailed in Chapter 3.

1.1.3 Where specific requirements are given in this Chapter for the class renewal survey, they are additional to the applicable requirements for the annual survey.

2 Service notations subject to additional surveys

2.1

2.1.1 The specific requirements detailed in this Chapter are linked to the service notation(s) assigned to the unit at the request of the Owner. Where a unit has more than one service notation, the specific requirements linked to each one are applicable, insofar as they are not contradictory (in such case, the most stringent requirement will be applied).

2.1.2 Tab 1 indicates which service notations are subject to specific requirements, and in which Section or Article they are specified.

Table 1 : Service notations for which specific requirements are applicable (1/7/2014)

Service notation assigned	Section applicable in this Chapter	Type of surveys affected by these specific requirements
FSO MOSU	Sec 2	annual survey intermediate survey class renewal survey
FPSO	Sec 3	annual survey intermediate survey class renewal survey
FSRU	Sec 4	annual survey intermediate survey class renewal survey
MODU	Sec 5	annual survey class renewal survey

SECTION 2

FSO AND MOSU

1 General

1.1 Application

1.11 The requirements of this Section apply to all units which have been assigned the service notations **FSO** or **MOSU**.

1.12 The requirements for hull surveys apply to the surveys of the hull structure and piping systems in way of cargo tanks, pump rooms, cofferdams, pipe tunnels and void spaces within the cargo area and all water ballast tanks. They are additional to the requirements applicable to the remainder of the unit, given in Chapter 3 according to the relevant surveys.

1.13 The requirements contain the minimum extent of examination, thickness measurements and tank testing. When substantial corrosion, as defined in Ch 2, Sec 2, [2.2.7], and/or structural defects are found, the survey is to be extended and is to include additional close-up surveys when necessary.

1.14 The requirements for machinery surveys apply to surveys of the machinery and equipment in the cargo area or dedicated to cargo service systems and are additional to those given in Chapter 3 for all units.

2 Annual survey - Hull items

2.1 General

2.11 The survey is to include:

- a) examination of the hull plating and its closing appliances as far as can be seen
- b) examination of watertight penetrations as far as practicable.
- c) examination of cargo tank openings, including gaskets, covers, coamings and flamescreens
- d) examination of cargo tank pressure/vacuum valves and flame screens
- e) examination of flame screens on vents to all bunker, oily ballast and oily slop tanks and void spaces, so far as is practicable
- f) examination of crude cargo washing, bunker, ballast and vent piping systems together with flame arrestors and pressure/vacuum valves, as applicable above the upper deck within the cargo tank area, including vent masts and headers
- g) confirmation that bridge deck doors and windows, sidescuttles and windows in superstructure and deck-house ends facing the cargo area are in satisfactory condition.

2.2 Cargo pump rooms and pipe tunnel

2.21 The survey is to include:

- a) examination of all pump room bulkheads and pipe tunnels (if any) for signs of oil leakage or fractures and, in particular, the sealing arrangements of penetrations in these bulkheads
- b) examination of the condition of all piping systems, in cargo pump rooms and pipe tunnels (if any)
- c) examination of the bilge and ballast arrangements.

2.3 Ballast tanks

2.31 For units greater than 15 years of age, all ballast tanks adjacent to (i.e. with a common plane boundary) a cargo tank with any means of heating are to be examined. Thickness measurement is to be carried out where considered necessary by the Surveyor. Special consideration may be given by the Surveyor to those tanks or spaces where the coatings are found in GOOD condition, as defined in Ch 2, Sec 2, [2.2.11], at the previous intermediate or class renewal survey.

2.32 For ballast tanks, in areas where substantial corrosion, as defined in Ch 2, Sec 2, [2.2.7], has been noted then additional measurements are to be carried out in accordance with Tables 5 to 8 or 9 to 13 for single hull units or double hull units, respectively. These extended thickness measurements are to be carried out before the survey is credited as completed.

3 Annual survey - Cargo machinery items

3.1 Cargo area and cargo pump rooms

3.11 The Owner or his representative is to declare to the attending Surveyor that no modifications or alterations which might impair safety have been made to the various installations in dangerous zones without prior approval from the Society.

The survey is to include:

- a) confirmation that potential sources of ignition in or near the cargo pump rooms, such as loose gear, excessive product in bilge, excessive vapours, combustible materials, etc., are eliminated and that access ladders are in satisfactory condition
- b) examination, as far as practicable, of cargo, bilge, ballast and stripping pumps for excessive gland seal leakage, verification of proper operation of electrical and mechanical remote operating and shutdown devices

and operation of the pump room bilge system, and checking that pump foundations are intact

- c) confirmation that the ventilation system, including portable equipment, if any, of all spaces in the cargo area (including cargo pump rooms) is operational, ducting is intact and screens are clean
- d) confirmation that electrical equipment in dangerous zones, cargo pump rooms and other spaces is in satisfactory condition and has been properly maintained
- e) confirmation that the remote operation of the cargo pump room bilge system is satisfactory
- f) examination of the cargo heating system
- g) examination of the cargo-transfer arrangement and confirmation that the unit's cargo hoses are suitable for their intended purpose and in satisfactory condition
- h) confirmation that any special arrangement made for bow or stern loading/unloading, as applicable, is in satisfactory condition and test of the means of communication and remote shutdown of the cargo pumps
- i) examination of the emergency lighting in all cargo pump rooms (for units constructed after 1 July 2002).

3.2 Instrumentation and safety devices

321 The survey is to include:

- a) Examination, so far as is possible, and testing as feasible, of the fire and/or smoke detection and alarm system(s)
- b) examination of cargo tank gauging devices, high level alarms and valves associated with overflow control
- c) verification that installed pressure gauges on cargo discharge lines and level indicator systems are operational
- d) confirmation that the required gas detection instruments are on board and satisfactory arrangements have been made for the supply of any required vapour detection tubes
- e) confirmation that devices provided for measuring the temperature of the cargo, if any, operate satisfactorily
- f) check of protection of the cargo pump room, and in particular of:
 - 1) temperature sensing devices for bulkhead glands and alarms;
 - 2) interlock between lighting and ventilation;
 - 3) gas detection system;
 - 4) bilge level monitoring devices and alarms.

3.3 Inert gas system

331 The survey is to include:

- a) external examination of the whole system, to check the condition of all piping, including vent piping above the upper deck in the cargo tank area and overboard discharges through the shell so far as practicable, and asso-

ciated components to verify, in particular, the absence of signs of corrosion and leakage of gas, water or other liquid from inert gas and water piping systems or from the pressure/vacuum breaking device

- b) check of proper operation of both inert gas blowers
- c) check of proper operation of ventilation system required for scrubber room (if any)
- d) check of deck water seal for automatic water filling and draining
- e) check of absence of water carry over in the inert gas from the deck water seal and check of the condition of the non-return valve
- f) check of proper operation of all remotely operated or automatically controlled valves and, in particular, of the flue gas isolating valve located on the inert gas supply main after the blowers
- g) check of proper operation of the interlocking feature fitted to prevent soot blowers from operating when the inert gas system is working
- h) check that the gas pressure regulating valve automatically closes when gas blowers are stopped
- i) check, as far as practicable and using simulated conditions where necessary, of the following alarms and safety devices of the inert gas system:
 - 1) high oxygen content of gas in the inert gas main;
 - 2) low gas pressure in the inert gas main
 - 3) low pressure in the supply to the deck water seal
 - 4) high temperature of gas in the inert gas main, including automatic shutdown devices
 - 5) low water pressure to the scrubber, including automatic shutdown devices
 - 6) accuracy of portable and fixed oxygen measuring equipment by means of calibration gases
 - 7) high water level in the scrubber, including automatic shutdown devices
 - 8) failure of the inert gas blowers
 - 9) failure of the power supply to the automatic control system for the gas regulating valve and to the instrumentation for continuous indication and permanent recording of pressure and oxygen content in the inert gas main
 - 10) high pressure of gas in the inert gas main
- j) check, when practicable, of the proper operation of the inert gas system on completion of the checks listed above.

3.4 Fire protection, detection and extinction

3.4.1 (1/7/2015)

The survey of fire prevention includes the examination, as far as practicable, and testing, as feasible and at random, of the fire and/or smoke detection systems.

4 Intermediate survey - Hull items

4.1 Weather decks

4.1.1 The survey is to include:

- a) examination, as far as applicable, of cargo, crude oil washing, bunker, ballast, steam and vent piping systems as well as vent masts and headers. If upon examination there is any doubt as to the condition of the piping, pressure testing, thickness measurement or both may be required
- b) confirmation that cargo pipes are electrically bonded to the hull
- c) examination of vent line drainage arrangements.

4.2 General

4.2.1 The survey extent is dependent on the age of the unit as specified in [4.4] to [4.5].

4.3 MOSU between 5 and 10 years of age

4.3.1 (1/7/2014)

The survey is to include a general, internal examination of representative ballast tanks. If there is no hard protective coating, or soft or semi-hard coating, or poor coating condition, the examination is to be extended to other ballast spaces of the same type; If considered necessary by the Surveyor, thickness measurements may be required.

If such examinations reveal no visible structural defects, the examination may be limited to verification that the corrosion prevention system remains effective.

For ballast tanks, excluding double bottom ballast tanks, if there is no hard protective coating, or soft or semi-hard coating, or poor coating condition and it is not renewed, the tanks in question are to be internally examined at annual surveys.

When such conditions are found in double bottom ballast tanks, the tanks in question may be internally examined at annual surveys.

4.4 Units between 10 and 15 years of age

4.4.1 The survey is to include:

- a) Overall survey of all water ballast tanks including any combined waterballast/crude cargo tanks.
- b) Overall survey of at least two representative crude cargo tanks.
- c) Close-up survey of water ballast tanks to the same extent as the previous Special Survey and two combined cargo/ballast tanks. Where protective coatings are found to be in GOOD condition, as defined in Ch 2, Sec 2, [2.2.11], the extent of Close-up survey may be specially considered.
- d) The thickness measurements of structures identified at the previous class renewal survey as having substantial corrosion. In areas where substantial corrosion, as defined in Ch 2, Sec 2, [2.2.7], is further found, then additional measurements are to be carried out in accordance with the requirements of Tab 5 to Tab 8 for

single hull FPSO units or Tab 9 to Tab 13 for double hull FPSO units. The survey will not be considered complete until these additional thickness measurements have been carried out.

- e) General examination of machinery and boiler spaces including tank tops, bilges and cofferdams, sea suction and overboard discharges.

4.4.2 (1/7/2014)

The internal examination of selected cargo spaces is to be carried out.

4.5 Units over 15 years of age

4.5.1 In addition to [4.4.1], a pressure testing of cargo and ballast tanks is to be carried out if deemed necessary by the attending Surveyor.

5 Intermediate survey - Cargo machinery items

5.1 Cargo area and cargo pump rooms

5.1.1 A general examination of the electrical equipment and cables in dangerous zones such as cargo pump rooms and areas adjacent to cargo tanks is to be carried out for defective and non-certified safe type electrical equipment and fixtures, non-approved lighting and fixtures, and improperly installed or defective or dead-end wiring.

5.1.2 The electrical insulation resistance of the electrical equipment and circuits terminating in or passing through the dangerous zones is to be tested; however, in cases where a proper record of testing is maintained, consideration may be given to accepting recent test readings effected by the unit's personnel.

5.1.3 The satisfactory condition of the cargo heating system is to be verified.

5.2 Inert gas system

5.2.1 For units over 10 years old at the time of the intermediate survey due date, the following is to be carried out:

- a) main parts such as the scrubber, washing machines, blowers, deck water seal and non-return valve are to be opened out as considered necessary and examined
- b) gas distribution lines and shut-off valves, including soot blower interlocking devices, are to be examined as deemed necessary
- c) all automatic shutdown devices and alarms are to be examined and tested.

6 Class renewal survey - Hull items

6.1 Planned survey program

6.1.1 The class renewal survey is to be carried out in accordance with the planned survey program indicated in Ch 2, Sec 2, [2.12].

6.1.2 The submitted planned survey program is to account of and comply with at least the requirements for close-up surveys, thickness measurements and tank testing given in Tab 1 or Tab 2, Tab 3 or Tab 4 and [6.5], respectively. In addition, the survey program should include at least:

- a) basic unit information and particulars;
- b) main structural plans of cargo and ballast tanks (scantling drawings), including information regarding use of high tensile steels (HTS);
- c) arrangement of tanks;
- d) list of tanks with information on their use, extent of coatings and corrosion protection systems;
- e) conditions for survey (e.g. information regarding tank cleaning, gas freeing, ventilation, lighting etc);
- f) provisions and methods for access to structures;
- g) equipment for surveys;
- h) identification of tanks and areas for close-up survey (see [6.3]);
- i) identification of areas and sections for thickness measurement (see [6.4]);
- j) identification of tanks for tank testing (see [6.5]);
- k) identification of the thickness measurement company;
- l) damage experience related to the unit in question; and
- m) critical structural areas and suspect areas, where relevant;
- n) requirements for carrying out in-water surveys in lieu of drydocking surveys.

6.1.3 In addition, the planned survey program is to include proposals on how to conduct surveys and tests in a safe and practical way, including the means of providing access to structures for close-up survey, thickness measurements and tank testing. All other provisions described in Ch 2, Sec 2, [2.3], Ch 2, Sec 2, [2.5] to Ch 2, Sec 2, [2.9] regarding procedures for thickness measurements, conditions for survey, access to structures, equipment for survey are also to be complied with.

6.1.4 Prior to commencement of any part of the renewal survey, a survey planning meeting is to be held between the attending Surveyor(s), the Owner's representative in attendance, the thickness measurement company operator (as applicable) for the purpose of ascertaining that all the arrangements envisaged in the planned survey program are in place, so as to ensure the safe and efficient conduct of the survey work to be carried out.

Table 1 : Requirements for close-up survey at class renewal survey of FSO or MOSU single hull units

Age of unit (in years at time of class renewal survey)			
age ≤ 5	5 < age ≤ 10	10 < age ≤ 15	age > 15
One web frame ring, in a wing ballast tank, if any, or a wing cargo tank used primarily for water ballast (1) (see Note 1)	All web frame rings, in a wing ballast tank, if any, or a wing cargo tank used primarily for water ballast (1) (see Note 1)	All web frame rings in all ballast tanks (1) (see Note 1) All web frame rings in a cargo wing tank (1) (see Note 1) A minimum of 30% (see Note 3) of all web frame rings in each remaining cargo wing tank (1) (see Note 1)	As class renewal survey for units between 10 and 15 years of age
<p>Note 1:(1), (2), (3), (4) and (5) are areas to be subjected to close-up surveys and thickness measurements (see Fig 1).</p> <p>(1) : Complete transverse web frame ring including adjacent structural member</p> <p>(2) : Deck transverse including adjacent deck structural members</p> <p>(3) : Transverse bulkhead complete, including girder system and adjacent structural members</p> <p>(4) : Transverse bulkhead lower part, including girder system and adjacent structural members</p> <p>(5) : Deck and bottom transverse, including adjacent structural members</p> <p>Note 2: Ballast tanks include peak tanks.</p> <p>Note 3: The 30% is to be rounded up to the next whole integer.</p>			

Age of unit (in years at time of class renewal survey)			
age ≤ 5	5 < age ≤ 10	10 < age ≤ 15	age > 15
One deck transverse, in a cargo tank (2) (see Note 1)	One deck transverse (2) (see Note 1):	All transverse bulkheads, in all cargo and ballast tanks (3) (see Note 1)	Additional transverse areas as deemed necessary by the Society
	<ul style="list-style-type: none"> • in each remaining ballast tank • in a cargo wing tank • in two cargo centretanks 		
	Both transverse bulkheads, in a wing ballast tank, if any, or a cargo wing tank used primarily for water ballast (3) (see Note 1)		
One transverse bulkhead in a ballast tank (4) (see Note 1) One transverse bulkhead in a cargo wing tank (4) (see Note 1) One transverse bulkhead in a cargo centre tank (4) (see Note 1)	One transverse bulkhead in each remaining ballast tank (4) (see Note 1) One transverse bulkhead in a cargo wing tank (4) (see Note 1) One transverse bulkhead in two cargo centre tanks (4) (see Note 1)	A minimum of 30% (see Note 3) of deck and bottom transverses including adjacent structural members, in each cargo centre tank (5) (see Note 1) Additional web frame ring(s) (1) (see Note 1), as considered necessary by the Surveyor	
<p>Note 1: (1), (2), (3), (4) and (5) are areas to be subjected to close-up surveys and thickness measurements (see Fig 1).</p> <p>(1) : Complete transverse web frame ring including adjacent structural member</p> <p>(2) : Deck transverse including adjacent deck structural members</p> <p>(3) : Transverse bulkhead complete, including girder system and adjacent structural members</p> <p>(4) : Transverse bulkhead lower part, including girder system and adjacent structural members</p> <p>(5) : Deck and bottom transverse, including adjacent structural members</p> <p>Note 2: Ballast tanks include peak tanks.</p> <p>Note 3: The 30% is to be rounded up to the next whole integer.</p>			

Table 2 : Requirements for close-up survey at class renewal survey of FSO or MOSU double hull units

Age of unit (in years at time of class renewal survey)			
age ≤ 5	5 < age ≤ 10	10 < age ≤ 15	age > 15
One web frame (1) (see Note 1), in a ballast tank (see Note 2)	All web frames (1) (see Note 1), in a ballast tank (see Note 2) The knuckle area and the upper part (approximately 5 metres) of one web frame in each remaining ballast tank (6) (see Note 1)	All web frames (1) (see Note 1), in all ballast tanks	As for class renewal survey for age from 10 to 15 years Additional transverse areas as deemed necessary by the Society
One deck transverse, in a cargo oil tank (2) (see Note 1)	One deck transverse, in two cargo oil tanks (2) (see Note 1)	All web frames (7 (see Note 1)), including deck transverse and cross ties, if fitted. in a cargo oil tank One web frame (7) (see Note 1), including deck transverse and cross ties, if fitted, in each remaining cargo oil tank	
One transverse bulkhead (4) (see Note 1), in a ballast tank (see Note 2)	One transverse bulkhead (4) (see Note 1), in each ballast tank (see Note 2)	All transverse bulkheads, in all cargo oil (3) (see Note 1) and ballast (4) (see Note 1) tanks	
One transverse bulkhead (5) (see Note 1) in a cargo oil centre tank One transverse bulkhead (5) (see Note 1), in a cargo oil wing tank (see Note 3)	One transverse bulkhead (5) (see Note 1), in two cargo oil centre tanks One transverse bulkhead (5) (see Note 1), in a cargo oil wing tank (see Note 3)		
<p>Note 1: (1), (2), (3), (4), (5), (6) and (7) are areas to be subjected to close-up surveys and thickness measurements ((see Sec 4, Fig 1 and Sec 4, Fig 2)</p> <p>(1) : "Web frame" in a ballast tank means vertical web in side tank, hopper web in hopper tank, floor in double bottom tank and deck transverse in double deck tank (where fitted), including adjacent structural members. In fore and aft peak tanks, "web frame" means a complete transverse web frame ring including adjacent structural members</p> <p>(2) : Deck transverse, including adjacent deck structural members (or external structure on deck in way of the tank, where applicable)</p> <p>(3) : Transverse bulkhead complete in cargo tanks, including girder system, adjacent structural members (such as longitudinal bulkheads) and internal structure of lower and upper stools, where fitted</p> <p>(4) : Transverse bulkhead complete in ballast tanks, including girder system and adjacent structural members, such as longitudinal bulkheads, girders in double bottom tanks, inner bottom plating, hopper side, connecting brackets</p> <p>(5) : Transverse bulkhead lower part in cargo tank, including girder system, adjacent structural members (such as longitudinal bulkheads) and internal structure of lower stool, where fitted</p> <p>(6) : The knuckle area and the upper part (approximately 5 metres), including adjacent structural members. Knuckle area is the area of the web frame around the connections of the slope hopper plating to the inner hull bulkhead and the inner bottom plating, up to 2 metres from the corners both on the bulkhead and the double bottom</p> <p>(7) : Web frame in a cargo oil tank means deck transverse, longitudinal bulkhead vertical girder and cross ties, where fitted, including adjacent structural members</p> <p>Note 2: Ballast tank: means double bottom tank plus double side tank plus double deck tank, as applicable, even if these tanks are separate</p> <p>Note 3: Where no centre cargo tanks are fitted (as in the case of centre longitudinal bulkhead), transverse bulkheads in wing tanks are to be surveyed.</p>			

Figure 1 : Areas subject to close-up surveys and thickness measurements for FSO single hull units

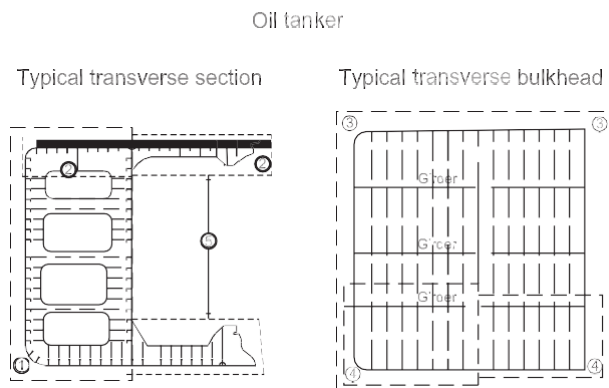

Figure 2 : Close-up survey requirements for FSO double hull units, areas (1) to (5)

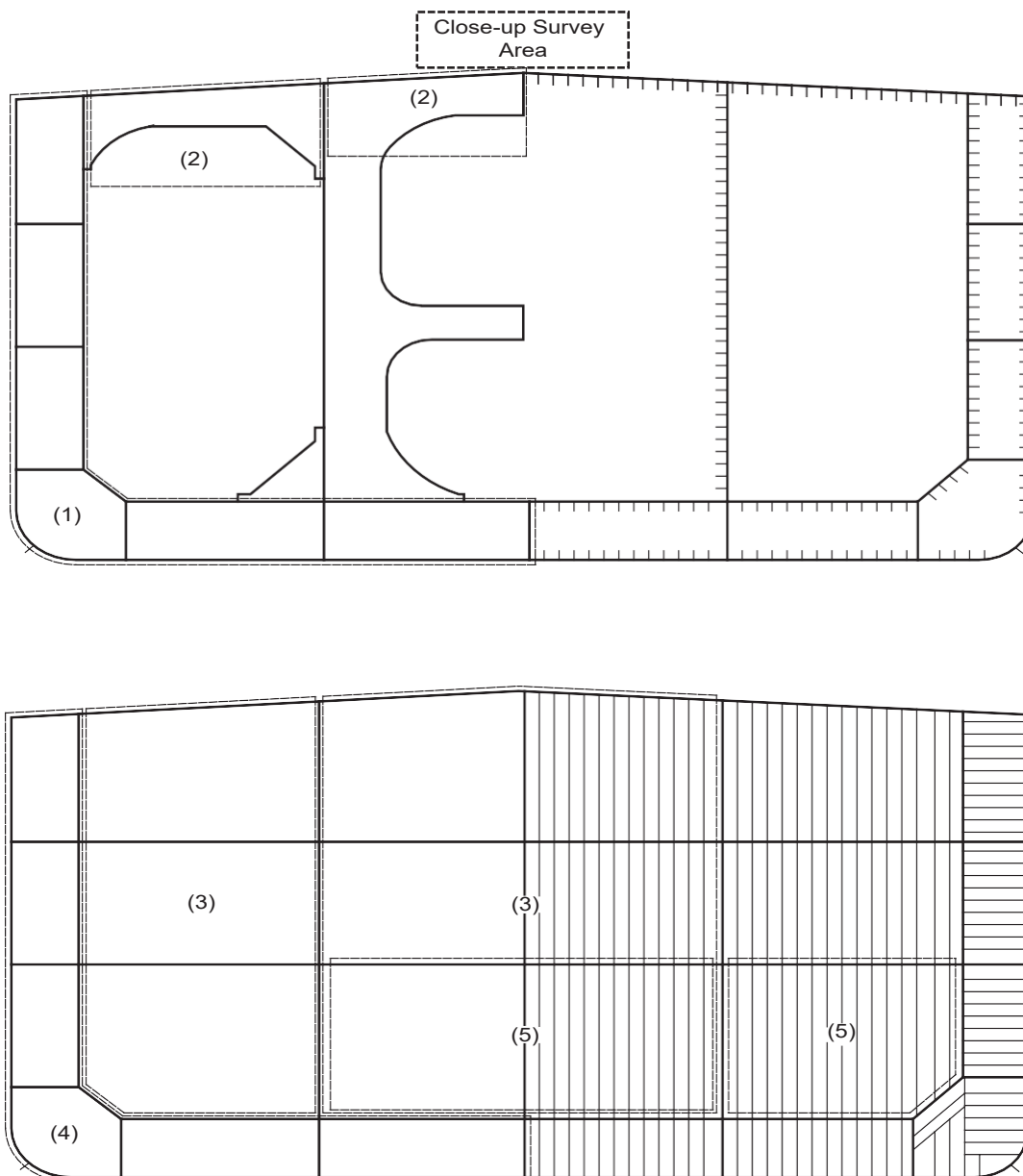
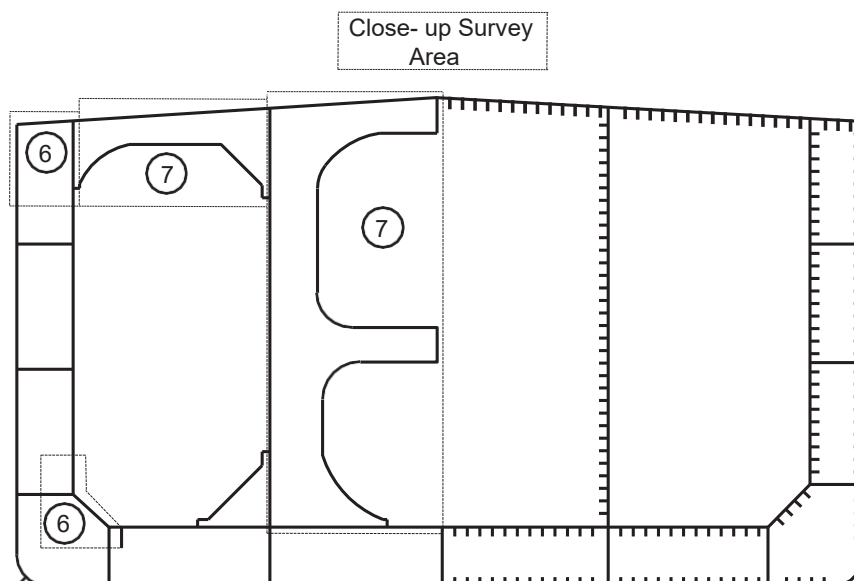

Figure 3 : Close-up survey requirements for FSO double hull units, areas (6) and (7)



6.2 Scope of survey

6.2.1 In addition to the requirements of annual surveys, the class renewal survey is to include examination, tests and checks of sufficient extent to ensure that the hull and related piping, as required in [6.6.1] are in satisfactory condition and fit for their intended purpose for the new period of class to be assigned, subject to proper maintenance and operation and to periodical surveys being carried out at the due dates.

6.2.2 All cargo tanks, ballast tanks, including double bottom tanks, pump rooms, pipe tunnels, cofferdams and void spaces bounding cargo tanks, decks and outer hull are to be examined, and this examination is to be supplemented by thickness measurement and testing required in [6.4] and [6.5], respectively, to ensure that the structural integrity remains effective. The aim of the examination is to discover substantial corrosion, significant deformation, fractures, damages or other structural deterioration that may be present.

6.2.3 The survey extent of ballast tanks converted to void spaces will be specially considered by the Society in relation to the requirements for ballast tanks.

6.3 Overall and close-up surveys

6.3.1 Each class renewal survey is to include an overall survey of all tanks and all spaces.

6.3.2 The minimum requirements for close-up surveys at class renewal surveys are given in Tab 1 and Tab 2, as applicable.

6.3.3 The Surveyor may extend the close-up survey as deemed necessary, taking into account the maintenance of

the tanks under survey, the condition of the corrosion prevention system and also in the following cases:

- where tanks have structural arrangements or details which have suffered defects in similar spaces or on similar units according to available information
- where tanks have structures approved with reduced scantlings due to an approved corrosion control system.

6.3.4 For areas in tanks where protective coatings are found to be in good condition, as defined in Ch 2, Sec 2, [2.2.11], the extent of close-up surveys required according to Tab 1 or Tab 2 may be specially considered.

6.4 Thickness measurements

6.4.1 The minimum requirements for thickness measurements at class renewal survey are given in Tab 3 and Tab 4, as applicable.

6.4.2 Provisions for extended measurements for areas with substantial corrosion are given in Tab 5 to Tab 8 or Tab 9 to Tab 13 and as may be additionally specified in the planned survey program as required in [6.1].

These extended thickness measurements are to be carried out before the survey is credited as completed. Suspect areas identified at previous class renewal or intermediate surveys are to be examined. Areas of substantial corrosion identified at previous class renewal or intermediate surveys are to be subjected to thickness measurements.

6.4.3 The Surveyor may further extend the thickness measurements as deemed necessary.

6.4.4 When pitting is found on bottom plating and its intensity is 20% or more, thickness measurements are to be extended in order to determine the actual plate thickness out of the pits and the depth of the pits. Where the wastage is in the substantial corrosion range or the average depth of pitting is 1/3 or more of the actual plate thickness, the pitted plate is to be considered as a substantially corroded area.

Table 3 : Requirements for thickness measurements at class renewal survey of FSO or MOSU single hull units

Age of unit (in years at time of class renewal survey)			
age ≤ 5	5 < age ≤ 10	10 < age ≤ 15	age > 15
Suspect areas	Suspect areas	Suspect areas	Suspect areas
One section of deck plating for the full beam of the unit within the cargo area (in way of a ballast tank, if any, or a cargo tank used primarily for water ballast)	Within the cargo area: <ul style="list-style-type: none"> • each deck plate (1) • 1 transverse section (2) 	Within the cargo area: <ul style="list-style-type: none"> • each deck plate (1) • 2 transverse sections (2) (3) • all wind and water strakes 	Within the cargo area: <ul style="list-style-type: none"> • each deck plate (1) • 3 transverse sections (2) (3) • each bottom plate
Measurements, for general assessment and recording of corrosion pattern, of those structural members subject to close-up survey according to Sec 3, Tab 2	Measurements, for general assessment and recording of corrosion pattern, of those structural members subject to close-up survey according to Sec 3, Tab 2	Measurements, for general assessment and recording of corrosion pattern, of those structural members subject to close-up survey according to Sec 3, Tab 2	Measurements, for general assessment and recording of corrosion pattern, of those structural members subject to close-up survey according to Sec 3, Tab 2
	Selected wind and water strakes outside the cargo area	Selected wind and water strakes outside the cargo area	All wind and water strakes, full length
<p>(1) For combination carriers only the deck plating outside line of cargo hold hatch openings is to be measured .</p> <p>(2) Transverse sections are to be chosen where the largest reductions are likely to occur or as revealed by deck plating measurements.</p> <p>(3) At least one section is to be within 0,5L amidships and, where applicable, in way of a ballast tank.</p>			

Table 4 : Requirements for thickness measurements at class renewal survey of FSO or MOSU double hull units

Age of unit (in years at time of class renewal survey)			
age ≤ 5	5 < age ≤ 10	10 < age ≤ 15	age > 15
Suspect areas	Suspect areas	Suspect areas	Suspect areas
One section of deck plating for the full beam of the unit within the cargo area	Within the cargo area: <ul style="list-style-type: none"> • each deck plate • one transverse section (1) 	Within the cargo area: <ul style="list-style-type: none"> • each deck plate • two transverse sections (1) (2) • all wind and water strakes 	Within the cargo area: <ul style="list-style-type: none"> • each deck plate • three transverse sections (1) (2) • each bottom plate
	Selected wind and water strakes outside the cargo area	Selected wind and water strakes outside the cargo area	All wind and water strakes, full length
Measurements, for general assessment and recording of corrosion pattern, of those structural members subject to close-up Survey according to Sec 4, Tab 2	Measurements, for general assessment and recording of corrosion pattern, of those structural members subject to close-up Survey according to Sec 4, Tab 2	Measurements, for general assessment and recording of corrosion pattern, of those structural members subject to close-up Survey according to Sec 4, Tab 2	Measurements, for general assessment and recording of corrosion pattern, of those structural members subject to close-up Survey according to Sec 4, Tab 2
<p>(1) transverse sections are to be chosen where the largest reductions are suspected to occur or are revealed from deck plating measurements</p> <p>(2) at least one section should be within 0,5L amidships</p>			

Table 5 : Requirements for extent of thickness measurements at those areas of substantial corrosion on FSO or MOSU single hull units within the cargo area

BOTTOM STRUCTURE		
Structural member	Extent of measurement	Pattern of measurement
Bottom plating	Minimum of 3 bays across tank, including aft bay Measurements around and under all suction bell mouths	5-point pattern for each panel between longitudinals and webs
Bottom longitudinals	Minimum of 3 longitudinals in each bay where bottom plating measured	3 measurements in line across flange and 3 measurements on vertical web
Bottom girders and brackets	At fore and aft transverse bulkhead, bracket toes and in centre of tanks	Vertical line of single measurements on web plating with one measurement between each panel stiffener, or a minimum of three measurements. Two measurements across face flat. 5-point pattern on girder/bulkhead brackets
Bottom transverse webs	3 webs in bays where bottom plating measured, with measurements at both ends and middle	5-point pattern over 2 square metre area. Single measurements on face flat
Panel stiffening	Where provided	Single measurements

Table 6 : Requirements for extent of thickness measurements at those areas of substantial corrosion on FSO or MOSU single hull units within the cargo area

DECK STRUCTURE		
Structural member	Extent of measurement	Pattern of measurement
Deck plating	Two bands across tank	Minimum of three measurements per plate per band
Deck longitudinals	Minimum of 3 longitudinals in each of two bays	3 measurements in line vertically on webs and 2 measurements on flange (if fitted)
Deck girders and brackets	At fore and aft transverse bulkhead, bracket toes and in centre of tanks	Vertical line of single measurements on web plating with one measurement between each panel stiffener, or a minimum of three measurements. Two measurements across face flat. 5-point pattern on girder/bulkhead brackets
Deck transverse webs	Minimum of 2 webs, with measurements at both ends and middle of span	5-point pattern over 2 square metre area. Single measurements on face flat
Panel stiffening	Where provided	Single measurements

Table 7 : Requirements for extent of thickness measurements at those areas of substantial corrosion on FSO or MOSU single hull units within the cargo area

SIDE SHELL AND LONGITUDINAL BULKHEADS		
Structural member	Extent of measurement	Pattern of measurement
Deckhead and bottom strakes and strakes in way of stringer platforms	Plating between each pair of longitudinals in a minimum of 3 bays	Single measurement
All other strakes	Plating between every third pair of longitudinals in same 3 bays	Single measurement
Longitudinals on deckhead and bottom strakes	Each longitudinal in same 3 bays	3 measurements across web and 1 measurement on flange
All other longitudinals	Every third longitudinal in same 3 bays	3 measurements across web and 1 measurement on flange
Longitudinal brackets	Minimum of 3 at top, middle and bottom of tank in same 3 bays	5-point pattern over area of bracket
Web frames and cross ties	3 webs with minimum of three locations on each web, including in way of cross tie connections	5-point pattern over approximately 2 square metre area, plus single measurements on web frame and cross tie face flats

Table 8 : Requirements for extent of thickness measurements at those areas of substantial corrosion on FSO or MOSU single hull units within the cargo area

TRANSVERSE BULKHEADS AND SWASH BULKHEADS		
Structural member	Extent of measurement	Pattern of measurement
Deckhead and bottom strakes, and strakes in way of stringer platforms	Plating between pair of stiffeners at three locations : approximately 1/4, 1/2 and 3/4 width of tank	5-point pattern between stiffeners over 1 metre length
All other strakes	Plating between pair of stiffeners at middle location	Single measurement
Strakes in corrugated bulkheads	Plating for each change of scantling at centre of panel and at flange of fabricated connection	5-point pattern over about 1 square metre of plating
Stiffeners	Minimum of three typical stiffeners	For web, 5-point pattern over span between bracket connections (2 measurements across web at each bracket connection and one at centre of span). For flange, single measurements at each bracket toe and at centre of span
Brackets	Minimum of three at top, middle and bottom of tank	5-point pattern over area of bracket
Deep webs and girders	Measurements at toe of bracket and at centre of span	For web, 5-point pattern over about 1 square metre. Three measurements across face flat
Stringer platforms	All stringers with measurements at both ends and middle	5-point pattern over 1 square metre of area plus single measurements near bracket toes and on face flats

Table 9 : Requirements for extent of thickness measurements at those areas of substantial corrosion on FSO or MOSU double hull units within the cargo area

BOTTOM, INNER BOTTOM AND HOPPER STRUCTURE		
Structural member	Extent of measurement	Pattern of measurement
Bottom, inner bottom and hopper structure plating	Minimum of three bays across double bottom tank, including aft bay Measurements around and under all suction bell mouths	5-point pattern for each panel between longitudinals and floors
Bottom, inner bottom and hopper structure longitudinals	Minimum of three longitudinals in each bay where bottom plating measured	Three measurements in line across flange and three measurements on vertical web
Bottom girders, including the watertight ones	At fore and aft watertight floors and in centre of tanks	Vertical line of single measurements on girder plating with one measurement between each panel stiffener, or a minimum of three measurements
Bottom floors, including the watertight ones	Three floors in bays where bottom plating measured, with measurements at both ends and middle	5-point pattern over two square metre area
Hopper structure web frame ring	Three floors in bays where bottom plating measured	5-point pattern over one square metre of plating. Single measurements on flange
Hopper structure transverse watertight bulkhead or swash bulkhead	<ul style="list-style-type: none"> lower 1/3 of bulkhead 	<ul style="list-style-type: none"> 5-point pattern over one square metre of plating
	<ul style="list-style-type: none"> upper 2/3 of bulkhead 	<ul style="list-style-type: none"> 5-point pattern over two square metre of plating
	<ul style="list-style-type: none"> stiffeners (minimum of three) 	<ul style="list-style-type: none"> For web, 5-point pattern over span (two measurements across web at each end and one at centre of span). For flange, single measurements at each end and centre of span
Panel stiffening	Where applicable	Single measurements

Table 10 : Requirements for extent of thickness measurements at those areas of substantial corrosion on FSO or MOSU double hull units within the cargo area

DECK STRUCTURE		
Structural member	Extent of measurement	Pattern of measurement
Deck plating	Two transverse bands across tank	Minimum of three measurements per plate per band
Deck longitudinals	Every third longitudinal in each of two bands with a minimum of one longitudinal	Three measurements in line vertically on webs and two measurements on flange (if fitted)
Deck girders and brackets (usually in cargo tanks only)	At fore and aft transverse bulkhead, bracket toes and in centre of tanks	Vertical line of single measurements on web plating with one measurement between each panel stiffener, or a minimum of three measurements. Two measurements across flange. 5-point pattern on girder/bulkhead brackets
Deck transverse webs	Minimum of two webs, with measurements at both ends and middle of span	5-point pattern over one square metre area. Single measurements on flange
Vertical web and transverse bulkhead in wing ballast tank (two metres from deck)	Minimum of two webs, and both transverse bulkheads	5-point pattern over one square metre area
Panel stiffening	Where applicable	Single measurements

Table 11 : Requirements for extent of thickness measurements at those areas of substantial corrosion on FSO or MOSU double hull units within the cargo area

STRUCTURE IN WING BALLAST TANKS		
Structural member	Extent of measurement	Pattern of measurement
Side shell and longitudinal bulkhead plating: <ul style="list-style-type: none"> • upper strake and strakes in way of horizontal girders • all other strakes 	<ul style="list-style-type: none"> • Plating between each pair of longitudinals in a minimum of three bays (along the tank) • Plating between every third pair of longitudinals in same three bays 	<ul style="list-style-type: none"> • Single measurement • Single measurement
Side shell and longitudinal bulkhead longitudinals on: <ul style="list-style-type: none"> • upper strake • all other strakes 	<ul style="list-style-type: none"> • Each longitudinal in same three bays • Every third longitudinal in same three bays 	<ul style="list-style-type: none"> • 3 measurements across web and 1 measurement on flange
Longitudinals - brackets	Minimum of three at top, middle and bottom of tank in same three bays	5-point pattern over area of bracket
Vertical web and transverse bulkheads (excluding deckhead area): <ul style="list-style-type: none"> • strakes in way of horizontal girders • other strakes 	<ul style="list-style-type: none"> • Minimum of two webs and both transverse bulkheads • Minimum of two webs and both transverse bulkheads 	<ul style="list-style-type: none"> • 5-point pattern over approx. two square metre area • two measurements between each pair of vertical stiffeners
Horizontal girders	Plating on each girder in a minimum of three bays	Two measurements between each pair of longitudinal girder stiffeners
Panel stiffening	Where applicable	Single measurements

Table 12 : Requirements for extent of thickness measurements at those areas of substantial corrosion on FSO or MOSU double hull units within the cargo area

LONGITUDINAL BULKHEADS IN CARGO TANKS		
Structural member	Extent of measurement	Pattern of measurement
Deckhead and bottom strakes, and strakes in way of the horizontal stringers of transverse bulkheads	Plating between each pair of longitudinals in a minimum of three bays	Single measurement
All other strakes	Plating between every third pair of longitudinals in same three bays	Single measurement
Longitudinals on deckhead and bottom strakes	Each longitudinal in same three bays	Three measurements across web and one measurement on flange
All other longitudinals	Every third longitudinal in same three bays	Three measurements across web and one measurement on flange
Longitudinals - brackets	Minimum of three at top, middle and bottom of tank in same three bays	5-point pattern over area of bracket
Web frames and cross ties	Three webs with minimum of three locations on each web, including in way of cross tie connections	5-point pattern over approximately two square metre area of webs, plus single measurements on flanges of web frame and crossties
Lower end brackets (opposite side of web frame)	Minimum of three brackets	5-point pattern over approximately two square metre area of brackets, plus single measurements on bracket flanges

Table 13 : Requirements for extent of thickness measurements at those areas of substantial corrosion on FSO or MOSU double hull units within the cargo area

TRANSVERSE WATERTIGHT AND SWASH BULKHEADS IN CARGO TANKS		
Structural member	Extent of measurement	Pattern of measurement
Upper and lower stool, where fitted	<ul style="list-style-type: none"> • Transverse band within 25mm of welded connection to inner bottom/deck plating • Transverse band within 25mm of welded connection to shelf plate 	5-point pattern between stiffeners over one metre length
Deckhead and bottom strakes, and strakes in way of horizontal stringers	Plating between pair of stiffeners at three locations : approximately 1/4, 1/2 and 3/4 width of tank	5-point pattern between stiffeners over one metre length
All other strakes	Plating between pair of stiffeners at middle location	Single measurement
Strakes in corrugated bulkheads	Plating for each change of scantling at centre of panel and at flange of fabricated connection	5-point pattern over about one square metre of plating
Stiffeners	Minimum of three typical stiffeners	For web, 5-point pattern over span between bracket connections (two measurements across web at each bracket connection and one at centre of span). For flange, single measurements at each bracket toe and at centre of span
Brackets	Minimum of three at top, middle and bottom of tank	5-point pattern over area of bracket
Horizontal stringers	All stringers with measurements at both ends and middle	5-point pattern over one square metre area, plus single measurements near bracket toes and on flanges

6.4.5 For areas in tanks where protective coatings are found to be in good condition as defined in Ch 2, Sec 2, [2.2.11], the extent of thickness measurements according to Tab 3 or Tab 4 may be specially considered.

6.4.6 Transverse sections are to be chosen where the largest reductions are suspected to occur or are revealed from deck plating measurements.

6.4.7 In cases where two or three sections are to be measured, at least one is to include a ballast tank within 0,5L amidships.

6.5 Tank testing

6.5.1 The requirements for tank testing at class renewal survey are given in Tab 14.

6.5.2 The Surveyor may extend the tank testing as deemed necessary.

6.5.3 Boundaries of ballast tanks are to be tested with a head of liquid to the top of air pipes.

6.5.4 Testing of boundaries of cargo tanks is to be carried out as agreed between the Society and Owners and reported in the planned survey program.

6.6 Cargo area and cargo pump rooms

6.6.1 Cargo piping on deck, including crude oil washing (cow) piping, and cargo and ballast piping within the cargo area are to be examined and operationally tested to working pressure to the attending Surveyor's satisfaction to ensure that their tightness and condition remain satisfactory. Special attention is to be given to any ballast piping in cargo tanks and cargo piping in ballast tanks and void spaces. Surveyors are to be advised on all occasions when this piping, including valves and fittings, is opened during repair periods and can be examined internally.

The surveyor may require dismantling and/or thickness measurements of piping. A hydraulic test is to be carried out in the event of repair or dismantling of cargo, crude oil washing, or ballast piping, or where doubts arise.

6.6.2 (15/12/2016)

All safety valves on cargo piping and of cargo tanks are to be dismantled for examination, adjusted and, as applicable, resealed.

Alternative methods, for the internal examination of the safety valves and their components and for the verification of their setting points, may be approved by the Society on a case by case basis.

6.6.3 All cargo pump room boundaries are to be generally examined. All gas-tight shaft sealing devices are to be examined. The bottom of cargo pump rooms is to be pre-

sented clean for the examination of stripping devices and gutters.

7 Class renewal survey - Cargo machinery items

7.1 Cargo area and cargo pump rooms

7.1.1 Ballast and stripping pumps are to be internally examined and prime movers checked. A working test is to be carried out, as far as practicable.

Maintenance records of cargo pumps are to be made available to the Surveyor.

7.1.2 Where a crude oil washing system is fitted, piping, pumps, valves and deck-mounted washing machines are to be examined and tested for signs of leakage, and anchoring devices of deck-mounted washing machines are to be checked to the Surveyor's satisfaction.

7.1.3 The satisfactory condition of the cargo heating system is to be verified and, if deemed necessary by the Surveyor, the system is to be pressure tested.

7.1.4 An operating test of the remote control of pumps and valves and of automatic closing valves is to be carried out.

7.1.5 A general examination of the electrical equipment and cables in dangerous zones such as cargo pump rooms and areas adjacent to cargo tanks is to be carried out for defective and non-certified safe type electrical equipment and fixtures, non-approved lighting and fixtures, and improperly installed or defective or dead-end wiring.

The electrical insulation resistance of the electrical equipment and circuits terminating in or passing through the dangerous zones is to be tested; however, in cases where a proper record of testing is maintained, consideration may be given to accepting recent test readings effected by the unit's personnel.

7.2 Inert gas system

7.2.1 In addition to the inspections required at the intermediate survey, the following is to be carried out:

- a) an internal examination of:
 - 1) the inert gas generator, where fitted
 - 2) the scrubber
 - 3) the deck water seal including the non-return valve
 - 4) the pressure/vacuum breaking device
 - 5) the cooling water systems including overboard discharge from the scrubber
 - 6) all valves
- b) a test to verify the proper operation of the system upon completion of all survey checks.

Table 14 : Requirements for tank testing at class renewal survey of FSO or MOSU units

Age of unit (in years at time of class renewal survey)	
age ≤ 5	age > 5
All ballast tank boundaries	All ballast tank boundaries
Cargo tank boundaries facing ballast tanks, void spaces, pipe tunnels, pump rooms or cofferdams	All cargo tank bulkheads

SECTION 3

FPSO AND FPU

1 General

1.1 Application

1.1.1 (1/7/2015)

The requirements of this Section apply to all units which have been assigned the service notations **FPSO** and **FPU**.

1.1.2 (1/7/2015)

The requirements for hull surveys apply to the surveys of the hull structure and piping systems in way of cargo tanks, pump rooms, cofferdams, pipe tunnels and void spaces within the cargo area and all water ballast tanks. They are additional to the requirements applicable to the remainder of the unit, given in Chapter 3 according to the relevant surveys.

For FPU units the survey requirements are applied according to its configuration.

The cargo tanks survey requirements are not applied to FPU units provided only with production and process installations without any hull arrangement which allows the storage, also if temporary, of the products (to be processed or already processed).

1.1.3 The requirements contain the minimum extent of examination, thickness measurements and tank testing. When substantial corrosion, as defined in Ch 2, Sec 2, [2.2.7], and/or structural defects are found, the survey is to be extended and is to include additional close-up surveys when necessary.

1.1.4 The requirements for machinery surveys apply to surveys of the machinery and equipment in the cargo area or dedicated to cargo service systems and are additional to those given in Chapter 3 for all units.

2 Annual survey - Hull items

2.1 General

2.1.1 The survey is to include:

- a) examination of the hull plating and its closing appliances as far as can be seen
- b) examination of watertight penetrations as far as practicable.

2.1.2 The survey is to include:

- a) examination of cargo tank openings, including gaskets, covers, coamings and flamescreens
- b) examination of cargo tank pressure/vacuum valves and flame screens
- c) examination of flame screens on vents to all bunker, oily ballast and oily slop tanks and void spaces, so far as is practicable

- d) examination of crude cargo washing, bunker, ballast and vent piping systems together with flame arrestors and pressure/vacuum valves, as applicable above the upper deck within the cargo tank area, including vent masts and headers
- e) confirmation that bridge deck doors and windows, sidescuttles and windows in superstructure and deck-house ends facing the cargo area are in satisfactory condition.

2.2 Cargo pump rooms and pipe tunnel

2.2.1 The survey is to include:

- a) examination of all pump room bulkheads and pipe tunnels (if any) for signs of oil leakage or fractures and, in particular, the sealing arrangements of penetrations in these bulkheads
- b) examination of the condition of all piping systems, in cargo pump rooms and pipe tunnels (if any)
- c) examination of the bilge and ballast arrangements.

2.3 Ballast tanks

2.3.1 For units greater than 15 years of age, all ballast tanks adjacent to (i.e. with a common plane boundary) a cargo tank with any means of heating are to be examined. Thickness measurement is to be carried out where considered necessary by the Surveyor. Special consideration may be given by the Surveyor to those tanks or spaces where the coatings are found in GOOD condition, as defined in Ch 2, Sec 2, [2.2.11], at the previous intermediate or class renewal survey.

2.3.2 For ballast tanks, in areas where substantial corrosion, as defined in Ch 2, Sec 2, [2.2.11], has been noted then additional measurements are to be carried out in accordance with Tables 5 to 8 or 9 to 13 for single hull units or double hull units, respectively. These extended thickness measurements are to be carried out before the survey is credited as completed.

3 Annual survey - Cargo machinery items

3.1 Cargo area and cargo pump rooms

3.1.1 The Owner or his representative is to declare to the attending Surveyor that no modifications or alterations which might impair safety have been made to the various installations in dangerous zones without prior approval from the Society.

The survey is to include:

- a) confirmation that potential sources of ignition in or near the cargo pump rooms, such as loose gear, excessive product in bilge, excessive vapours, combustible materials, etc., are eliminated and that access ladders are in satisfactory condition
- b) examination, as far as practicable, of cargo, bilge, ballast and stripping pumps for excessive gland seal leakage, verification of proper operation of electrical and mechanical remote operating and shutdown devices and operation of the pump room bilge system, and checking that pump foundations are intact
- c) confirmation that the ventilation system, including portable equipment, if any, of all spaces in the cargo area (including cargo pump rooms) is operational, ducting is intact and screens are clean
- d) confirmation that electrical equipment in dangerous zones, cargo pump rooms and other spaces is in satisfactory condition and has been properly maintained
- e) confirmation that the remote operation of the cargo pump room bilge system is satisfactory
- f) examination of the cargo heating system
- g) examination of the cargo-transfer arrangement and confirmation that the unit's cargo hoses are suitable for their intended purpose and in satisfactory condition
- h) confirmation that any special arrangement made for bow or stern loading/unloading, as applicable, is in satisfactory condition and test of the means of communication and remote shutdown of the cargo pumps
- i) examination of the emergency lighting in all cargo pump rooms (for units constructed after 1 July 2002).

3.2 Instrumentation and safety devices

3.2.1 The survey is to include:

- a) Examination, so far as is possible, and testing as feasible, of the fire and/or smoke detection and alarm system(s)
- b) examination of cargo tank gauging devices, high level alarms and valves associated with overflow control
- c) verification that installed pressure gauges on cargo discharge lines and level indicator systems are operational
- d) confirmation that the required gas detection instruments are on board and satisfactory arrangements have been made for the supply of any required vapour detection tubes
- e) confirmation that devices provided for measuring the temperature of the cargo, if any, operate satisfactorily
- f) check of protection of the cargo pump room, and in particular of:
 - 1) temperature sensing devices for bulkhead glands and alarms;
 - 2) interlock between lighting and ventilation;
 - 3) gas detection system;
 - 4) bilge level monitoring devices and alarms.

3.3 Inert gas system

3.3.1 The survey is to include:

- a) external examination of the whole system, to check the condition of all piping, including vent piping above the upper deck in the cargo tank area and overboard discharges through the shell so far as practicable, and associated components to verify, in particular, the absence of signs of corrosion and leakage of gas, water or other liquid from inert gas and water piping systems or from the pressure/vacuum breaking device
- b) check of proper operation of both inert gas blowers
- c) check of proper operation of ventilation system required for scrubber room (if any)
- d) check of deck water seal for automatic water filling and draining
- e) check of absence of water carry over in the inert gas from the deck water seal and check of the condition of the non-return valve
- f) check of proper operation of all remotely operated or automatically controlled valves and, in particular, of the flue gas isolating valve located on the inert gas supply main after the blowers
- g) check of proper operation of the interlocking feature fitted to prevent soot blowers from operating when the inert gas system is working
- h) check that the gas pressure regulating valve automatically closes when gas blowers are stopped
- i) check, as far as practicable and using simulated conditions where necessary, of the following alarms and safety devices of the inert gas system:
 - 1) high oxygen content of gas in the inert gas main;
 - 2) low gas pressure in the inert gas main
 - 3) low pressure in the supply to the deck water seal
 - 4) high temperature of gas in the inert gas main, including automatic shutdown devices
 - 5) low water pressure to the scrubber, including automatic shutdown devices
 - 6) accuracy of portable and fixed oxygen measuring equipment by means of calibration gases
 - 7) high water level in the scrubber, including automatic shutdown devices
 - 8) failure of the inert gas blowers
 - 9) failure of the power supply to the automatic control system for the gas regulating valve and to the instrumentation for continuous indication and permanent recording of pressure and oxygen content in the inert gas main
 - 10) high pressure of gas in the inert gas main
- j) check, when practicable, of the proper operation of the inert gas system on completion of the checks listed above.

3.4 Fire protection, detection and extinction

3.4.1 (1/7/2015)

The survey of fire prevention includes the examination, as far as practicable, and testing, as feasible and at random, of the fire and/or smoke detection systems.

4 Annual survey - Production and process installations

4.1 Fire protection, detection and extinction

4.1.1 For units with production and process installations the arrangements for fire protection, detection and extinction exclusively related to production and process are to be examined and include the following:

- a) Verification, so far as is practicable, that no significant changes have been made to the arrangement of structural fire protection.
- b) Verification of the operation of manual and/or automatic doors where fitted.
- c) Verification that fire control plans are properly posted.
- d) Examination, so far as is possible, and testing as feasible, of the fire and/or smoke detection and alarm system(s).
- e) Examination of fire main system, and confirmation that each fire pump, including the emergency fire pump, can be operated separately so that sufficient water can be produced to meet the greatest calculated demand in a credible emergency scenario.
- f) Verification that fire-hoses, nozzles, applicators and spanners are in good working condition and situated at their respective locations.
- g) Examination of fixed fire-fighting systems controls, piping, instructions and marking, checking for evidence or proper maintenance and servicing, including date of last systems tests.
- h) Verification that all portable and semi-portable fire-extinguishers are in their stowed positions, checking for evidence of proper maintenance and servicing, conducting random checks for evidence of discharges containers.
- i) Verification, so far as is practicable, that the remote control for stopping fans and machinery and shutting off fuel supplies in machinery spaces and, where fitted, the remote controls for stopping fans in accommodation spaces and the means of cutting off power to the galley are in good working order.
- j) Examination of the closing arrangements of ventilators, funnel annular spaces, skylights, doorways and tunnels, where applicable.
- k) Verification that the fireman's outfits are complete and in good condition.
- l) Examination of the electrical installation in areas which may contain flammable gas or vapour and/or combus-

tible dust to verify it is in good condition and has been properly maintained.

- m) External examination of the piping and shut off valves of cargo tank and cargo pump room fixed fire-fighting system.
- n) Verification that the deck foam system and deck deluge system are in good operating condition.

In addition the passive fire protection systems to the topsides process modules and associated plant are to be examined and verified, so far as practicable, that no significant changes have been made to the arrangement of structural fire protection.

4.2 Production and process installation

4.2.1 For units with a production and process installation the Owner is to submit to the Society a planned procedure for maintenance and inspection of the installation for review and agreement by the Society from the survey aspects in advance of the first survey, see Ch 2, Sec 2, [2.12]. A copy is to be kept on board and made available to the Surveyor. The planned surveys and procedures as agreed by the Society will be subject to revision if found necessary at subsequent surveys or when required by the Surveyor.

4.2.2 The Surveyor is to be satisfied as far as is practicable as to the efficient condition of the following components to the production and process installation referred to in [4.2.1] as applicable.

- a) Major equipment and structures of the production and process installation.
- b) Oil processing system.
- c) Production installation safety systems.
- d) Production installation utility systems.
- e) Relief and flare system.
- f) Well control system.

4.2.3 Pressure vessels are to be examined only at the first annual survey after commissioning in accordance with the requirements for class renewal surveys given in [9.1.2] and [9.1.3]. Thereafter, they are to be examined at subsequent class renewal surveys.

4.2.4 Where due to operational requirements it is not possible to present all pressure vessels for inspection at the first annual survey, a sufficient number of pressure vessels from each system are to be examined, as agreed with the Surveyor, in order to establish the extent of corrosion and general condition of the system. The Owner's proposals for the inspection of the remaining pressure vessels are to be included in the Owner's planned maintenance and inspection procedure as required in Ch 2, Sec 2, [2.12].

4.2.5 (15/12/2016)

Selected pressure safety valves are to be bench tested in accordance with a planned procedure for maintenance and inspection, see [4.2.1].

As an alternative to bench testing of the safety valves, approved procedures for their testing in situ may be adopted at any annual survey.

5 Intermediate survey - Hull items

5.1 Weather decks

5.1.1 The survey is to include:

- a) examination, as far as applicable, of cargo, crude oil washing, bunker, ballast, steam and vent piping systems as well as vent masts and headers. If upon examination there is any doubt as to the condition of the piping, pressure testing, thickness measurement or both may be required
- b) confirmation that cargo pipes are electrically bonded to the hull
- c) examination of vent line drainage arrangements.

5.2 General

5.2.1 The survey extent is dependent on the age of the unit as specified in [5.3] and [5.4].

5.3 Units between 10 and 15 years of age

5.3.1 The survey is to include:

- a) Overall survey of all water ballast tanks including any combined waterballast/crude cargo tanks.
- b) Overall survey of at least two representative crude cargo tanks.
- c) Close-up survey of water ballast tanks to the same extent as the previous Special Survey and two combined cargo/ballast tanks. Where protective coatings are found to be in GOOD condition, as defined in Ch 2, Sec 2, [2.2.11], the extent of Close-up survey may be specially considered.
- d) The thickness measurements of structures identified at the previous class renewal survey as having substantial corrosion. In areas where substantial corrosion, as defined in Ch 2, Sec 2, [2.2.7], is further found, then additional measurements are to be carried out in accordance with the requirements of Tab 5 to Tab 8 for single hull FPSO units or Tab 9 to Tab 13 for double hull FPSO units. The survey will not be considered complete until these additional thickness measurements have been carried out.
- e) General examination of machinery and boiler spaces including tank tops, bilges and cofferdams, sea suction and overboard discharges.

5.4 Units over 15 years of age

5.4.1 In addition to [5.3.1], a pressure testing of cargo and ballast tanks is to be carried out if deemed necessary by the attending Surveyor.

6 Intermediate survey - Cargo machinery items

6.1 Cargo area and cargo pump rooms

6.1.1 A general examination of the electrical equipment and cables in dangerous zones such as cargo pump rooms and areas adjacent to cargo tanks is to be carried out for defective and non-certified safe type electrical equipment and fixtures, non-approved lighting and fixtures, and improperly installed or defective or dead-end wiring.

6.1.2 The electrical insulation resistance of the electrical equipment and circuits terminating in or passing through the dangerous zones is to be tested; however, in cases where a proper record of testing is maintained, consideration may be given to accepting recent test readings effected by the unit's personnel.

6.1.3 The satisfactory condition of the cargo heating system is to be verified.

6.2 Inert gas system

6.2.1 For units over 10 years old at the time of the intermediate survey due date, the following is to be carried out:

- a) main parts such as the scrubber, washing machines, blowers, deck water seal and non-return valve are to be opened out as considered necessary and examined
- b) gas distribution lines and shut-off valves, including soot blower interlocking devices, are to be examined as deemed necessary
- c) all automatic shutdown devices and alarms are to be examined and tested.

7 Class renewal survey - Hull items

7.1 Planned survey program

7.1.1 The class renewal survey is to be carried out in accordance with the planned survey program indicated in Ch 2, Sec 2, [2.12].

7.1.2 The submitted planned survey program is to account of and comply with at least the requirements for close-up surveys, thickness measurements and tank testing given in Tab 1 or Tab 2, Tab 3 or Tab 4 and [6.5], respectively. In addition, the survey program should include at least:

- a) basic unit information and particulars;
- b) main structural plans of cargo and ballast tanks (scantling drawings), including information regarding use of high tensile steels (HTS);
- c) arrangement of tanks;
- d) list of tanks with information on their use, extent of coatings and corrosion protection systems;
- e) conditions for survey (e.g. information regarding tank cleaning, gas freeing, ventilation, lighting etc);
- f) provisions and methods for access to structures;
- g) equipment for surveys;

- h) identification of tanks and areas for close-up survey (see [7.3]);
- i) identification of areas and sections for thickness measurement (see [7.4]);
- j) identification of tanks for tank testing (see [7.5]);
- k) identification of the thickness measurement company;
- l) damage experience related to the unit in question;
- m) critical structural areas and suspect areas, where relevant; and
- n) requirements for carrying out in-water surveys in lieu of drydocking surveys.

7.1.3 In addition, the planned survey program is to include proposals on how to conduct surveys and tests in a safe and practical way, including the means of providing access to

structures for close-up survey, thickness measurements and tank testing. All other provisions described in Ch 2, Sec 2, [2.3], Ch 2, Sec 2, [2.5] to Ch 2, Sec 2, [2.9] regarding procedures for thickness measurements, conditions for survey, access to structures, equipment for survey are also to be complied with.

7.1.4 Prior to commencement of any part of the renewal survey, a survey planning meeting is to be held between the attending Surveyor(s), the Owner's representative in attendance, the thickness measurement company operator (as applicable) for the purpose of ascertaining that all the arrangements envisaged in the planned survey program are in place, so as to ensure the safe and efficient conduct of the survey work to be carried out.

Table 1 : Requirements for close-up survey at class renewal survey of FPSO and FPU single hull units

Age of unit (in years at time of class renewal survey)			
age ≤ 5	5 < age ≤ 10	10 < age ≤ 15	age > 15
One web frame ring, in a wing ballast tank, if any, or a wing cargo tank used primarily for water ballast (1) (see Note 1)	All web frame rings, in a wing ballast tank, if any, or a wing cargo tank used primarily for water ballast (1) (see Note 1)	All web frame rings in all ballast tanks (1) (see Note 1) All web frame rings in a cargo wing tank (1) (see Note 1) A minimum of 30% (see Note 3) of all web frame rings in each remaining cargo wing tank (1) (see Note 1)	As class renewal survey for units between 10 and 15 years of age
One deck transverse, in a cargo tank (2) (see Note 1)	One deck transverse (2) (see Note 1): <ul style="list-style-type: none"> • in each remaining ballast tank • in a cargo wing tank • in two cargo centretanks Both transverse bulkheads, in a wing ballast tank, if any, or a cargo wing tank used primarily for water ballast (3) (see Note 1)	All transverse bulkheads, in all cargo and ballast tanks (3) (see Note 1)	Additional transverse areas as deemed necessary by the Society
One transverse bulkhead in a ballast tank (4) (see Note 1) One transverse bulkhead in a cargo wing tank (4) (see Note 1) One transverse bulkhead in a cargo centre tank (4) (see Note 1)	One transverse bulkhead in each remaining ballast tank (4) (see Note 1) One transverse bulkhead in a cargo wing tank (4) (see Note 1) One transverse bulkhead in two cargo centre tanks (4) (see Note 1)	A minimum of 30% (see Note 3) of deck and bottom transverses including adjacent structural members, in each cargo centre tank (5) (see Note 1) Additional web frame ring(s) (1) (see Note 1), as considered necessary by the Surveyor	
<p>Note 1: (1), (2), (3), (4) and (5) are areas to be subjected to close-up surveys and thickness measurements (see Fig 1).</p> <p>(1) : Complete transverse web frame ring including adjacent structural member</p> <p>(2) : Deck transverse including adjacent deck structural members</p> <p>(3) : Transverse bulkhead complete, including girder system and adjacent structural members</p> <p>(4) : Transverse bulkhead lower part, including girder system and adjacent structural members</p> <p>(5) : Deck and bottom transverse, including adjacent structural members</p> <p>Note 2: Ballast tanks include peak tanks.</p> <p>Note 3: The 30% is to be rounded up to the next whole integer.</p>			

Table 2 : Requirements for close-up survey at class renewal survey of FPSO and FPU double hull units

Age of unit (in years at time of class renewal survey)			
age ≤ 5	5 < age ≤ 10	10 < age ≤ 15	age > 15
One web frame (1) (see Note 1), in a ballast tank (see Note 2)	All web frames (1) (see Note 1), in a ballast tank (see Note 2) The knuckle area and the upper part (approximately 5 metres) of one web frame in each remaining ballast tank (6) (see Note 1)	All web frames (1) (see Note 1), in all ballast tanks	As for class renewal survey for age from 10 to 15 years Additional transverse areas as deemed necessary by the Society
One deck transverse, in a cargo oil tank (2) (see Note 1)	One deck transverse, in two cargo oil tanks (2) (see Note 1)	All web frames (7 (see Note 1)), including deck transverse and cross ties, if fitted. in a cargo oil tank One web frame (7) (see Note 1), including deck transverse and cross ties, if fitted, in each remaining cargo oil tank	
One transverse bulkhead (4) (see Note 1), in a ballast tank (see Note 2)	One transverse bulkhead (4) (see Note 1), in each ballast tank (see Note 2)	All transverse bulkheads, in all cargo oil (3) (see Note 1) and ballast (4) (see Note 1) tanks	
One transverse bulkhead (5) (see Note 1) in a cargo oil centre tank One transverse bulkhead (5) (see Note 1), in a cargo oil wing tank (see Note 3)	One transverse bulkhead (5) (see Note 1), in two cargo oil centre tanks One transverse bulkhead (5) (see Note 1), in a cargo oil wing tank (see Note 3)		
<p>Note 1: (1), (2), (3), (4), (5), (6) and (7) are areas to be subjected to close-up surveys and thickness measurements (see Fig 1 and Fig 2))</p> <p>(1) : "Web frame" in a ballast tank means vertical web in side tank, hopper web in hopper tank, floor in double bottom tank and deck transverse in double deck tank (where fitted), including adjacent structural members. In fore and aft peak tanks, "web frame" means a complete transverse web frame ring including adjacent structural members</p> <p>(2) : Deck transverse, including adjacent deck structural members (or external structure on deck in way of the tank, where applicable)</p> <p>(3) : Transverse bulkhead complete in cargo tanks, including girder system, adjacent structural members (such as longitudinal bulkheads) and internal structure of lower and upper stools, where fitted</p> <p>(4) : Transverse bulkhead complete in ballast tanks, including girder system and adjacent structural members, such as longitudinal bulkheads, girders in double bottom tanks, inner bottom plating, hopper side, connecting brackets</p> <p>(5) : Transverse bulkhead lower part in cargo tank, including girder system, adjacent structural members (such as longitudinal bulkheads) and internal structure of lower stool, where fitted</p> <p>(6) : The knuckle area and the upper part (approximately 5 metres), including adjacent structural members. Knuckle area is the area of the web frame around the connections of the slope hopper plating to the inner hull bulkhead and the inner bottom plating, up to 2 metres from the corners both on the bulkhead and the double bottom</p> <p>(7) : Web frame in a cargo oil tank means deck transverse, longitudinal bulkhead vertical girder and cross ties, where fitted, including adjacent structural members</p> <p>Note 2: Ballast tank: means double bottom tank plus double side tank plus double deck tank, as applicable, even if these tanks are separate</p> <p>Note 3: Where no centre cargo tanks are fitted (as in the case of centre longitudinal bulkhead), transverse bulkheads in wing tanks are to be surveyed.</p>			

Figure 1 : Areas subject to close-up surveys and thickness measurements for FPSO and FPU single hull units

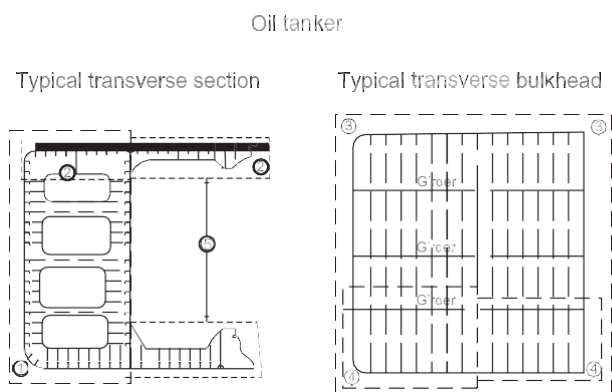

Figure 2 : Close-up survey requirements for FPSO and FPU double hull units, areas (1) to (5)

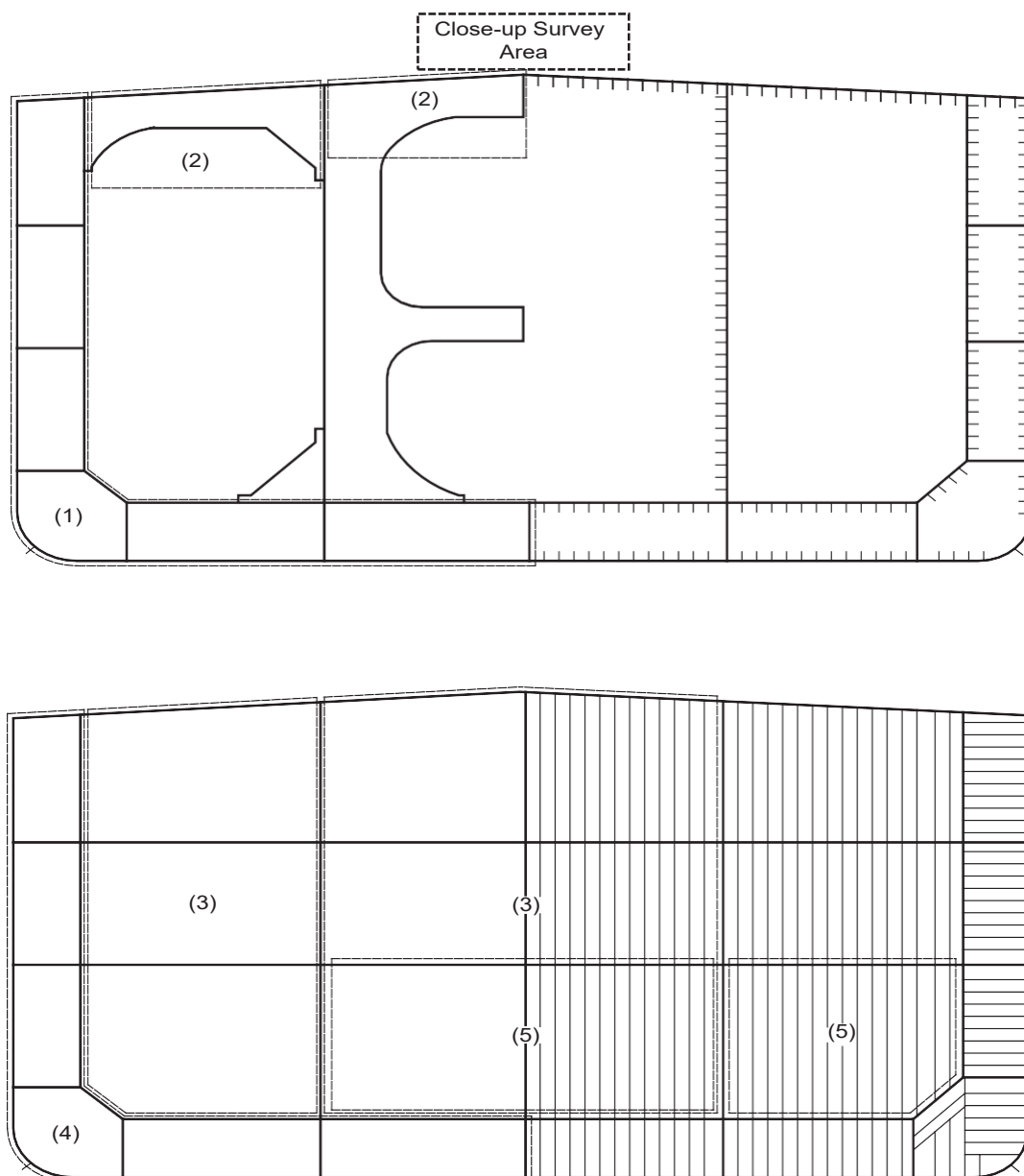
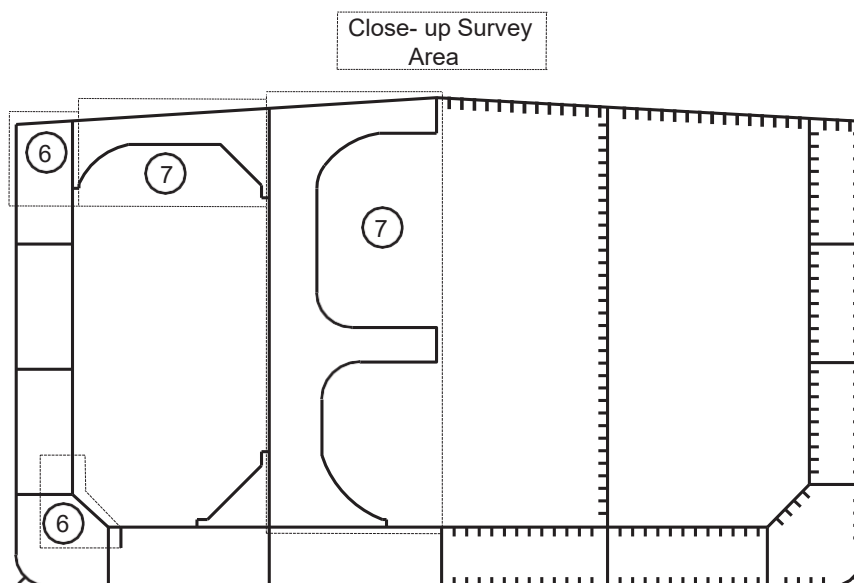

Figure 3 : Close-up survey requirements for FPSO and FPU double hull units, areas (6) and (7)



7.2 Scope of survey

7.2.1 In addition to the requirements of annual surveys, the class renewal survey is to include examination, tests and checks of sufficient extent to ensure that the hull and related piping, as required in [7.6.1] are in satisfactory condition and fit for their intended purpose for the new period of class to be assigned, subject to proper maintenance and operation and to periodical surveys being carried out at the due dates.

7.2.2 All cargo tanks, ballast tanks, including double bottom tanks, pump rooms, pipe tunnels, cofferdams and void spaces bounding cargo tanks, decks and outer hull are to be examined, and this examination is to be supplemented by thickness measurement and testing required in [7.4] and [7.5], respectively, to ensure that the structural integrity remains effective. The aim of the examination is to discover substantial corrosion, significant deformation, fractures, damages or other structural deterioration that may be present.

7.2.3 The survey extent of ballast tanks converted to void spaces will be specially considered by the Society in relation to the requirements for ballast tanks.

7.3 Overall and close-up surveys

7.3.1 Each class renewal survey is to include an overall survey of all tanks and all spaces.

7.3.2 The minimum requirements for close-up surveys at class renewal surveys are given in Tab 1 and Tab 2, as applicable.

7.3.3 The Surveyor may extend the close-up survey as deemed necessary, taking into account the maintenance of

the tanks under survey, the condition of the corrosion prevention system and also in the following cases:

- where tanks have structural arrangements or details which have suffered defects in similar spaces or on similar units according to available information
- where tanks have structures approved with reduced scantlings due to an approved corrosion control system.

7.3.4 For areas in tanks where protective coatings are found to be in good condition, as defined in Ch 2, Sec 2, [2.2.11], the extent of close-up surveys required according to Tab 1 or Tab 2 may be specially considered.

7.4 Thickness measurements

7.4.1 The minimum requirements for thickness measurements at class renewal survey are given in Tab 3 and Tab 4, as applicable.

7.4.2 Provisions for extended measurements for areas with substantial corrosion are given in Tab 5 to Tab 8 or Tab 9 to Tab 13 and as may be additionally specified in the planned survey program as required in [7.1].

These extended thickness measurements are to be carried out before the survey is credited as completed. Suspect areas identified at previous class renewal or intermediate surveys are to be examined. Areas of substantial corrosion identified at previous class renewal or intermediate surveys are to be subjected to thickness measurements.

7.4.3 The Surveyor may further extend the thickness measurements as deemed necessary.

7.4.4 When pitting is found on bottom plating and its intensity is 20% or more, thickness measurements are to be extended in order to determine the actual plate thickness out of the pits and the depth of the pits. Where the wastage is in the substantial corrosion range or the average depth of pitting is 1/3 or more of the actual plate thickness, the pitted plate is to be considered as a substantially corroded area.

Table 3 : Requirements for thickness measurements at class renewal survey of FPSO and FPU single hull units

Age of unit (in years at time of class renewal survey)			
age ≤ 5	5 < age ≤ 10	10 < age ≤ 15	age > 15
Suspect areas	Suspect areas	Suspect areas	Suspect areas
One section of deck plating for the full beam of the unit within the cargo area (in way of a ballast tank, if any, or a cargo tank used primarily for water ballast)	Within the cargo area: <ul style="list-style-type: none"> • each deck plate (1) • 1 transverse section (2) 	Within the cargo area: <ul style="list-style-type: none"> • each deck plate (1) • 2 transverse sections (2) (3) • all wind and water strakes 	Within the cargo area: <ul style="list-style-type: none"> • each deck plate (1) • 3 transverse sections (2) (3) • each bottom plate
Measurements, for general assessment and recording of corrosion pattern, of those structural members subject to close-up survey according to Tab 2	Measurements, for general assessment and recording of corrosion pattern, of those structural members subject to close-up survey according to Tab 2	Measurements, for general assessment and recording of corrosion pattern, of those structural members subject to close-up survey according to Tab 2	Measurements, for general assessment and recording of corrosion pattern, of those structural members subject to close-up survey according to Tab 2
	Selected wind and water strakes outside the cargo area	Selected wind and water strakes outside the cargo area	All wind and water strakes, full length
<p>(1) For combination carriers only the deck plating outside line of cargo hold hatch openings is to be measured .</p> <p>(2) Transverse sections are to be chosen where the largest reductions are likely to occur or as revealed by deck plating measurements.</p> <p>(3) At least one section is to be within 0,5L amidships and, where applicable, in way of a ballast tank.</p>			

Table 4 : Requirements for thickness measurements at class renewal survey of FPSO and FPU double hull units

Age of unit (in years at time of class renewal survey)			
age ≤ 5	5 < age ≤ 10	10 < age ≤ 15	age > 15
Suspect areas	Suspect areas	Suspect areas	Suspect areas
One section of deck plating for the full beam of the unit within the cargo area	Within the cargo area: <ul style="list-style-type: none"> • each deck plate • one transverse section (1) 	Within the cargo area: <ul style="list-style-type: none"> • each deck plate • two transverse sections (1) (2) • all wind and water strakes 	Within the cargo area: <ul style="list-style-type: none"> • each deck plate • three transverse sections (1) (2) • each bottom plate
	Selected wind and water strakes outside the cargo area	Selected wind and water strakes outside the cargo area	All wind and water strakes, full length
Measurements, for general assessment and recording of corrosion pattern, of those structural members subject to close-up Survey according to Sec 4, Tab 2	Measurements, for general assessment and recording of corrosion pattern, of those structural members subject to close-up Survey according to Sec 4, Tab 2	Measurements, for general assessment and recording of corrosion pattern, of those structural members subject to close-up Survey according to Sec 4, Tab 2	Measurements, for general assessment and recording of corrosion pattern, of those structural members subject to close-up Survey according to Sec 4, Tab 2
<p>(1) transverse sections are to be chosen where the largest reductions are suspected to occur or are revealed from deck plating measurements</p> <p>(2) at least one section should be within 0,5L amidships</p>			

Table 5 : Requirements for extent of thickness measurements at those areas of substantial corrosion on FPSO and FPU single hull units within the cargo area

BOTTOM STRUCTURE		
Structural member	Extent of measurement	Pattern of measurement
Bottom plating	Minimum of 3 bays across tank, including aft bay Measurements around and under all suction bell mouths	5-point pattern for each panel between longitudinals and webs
Bottom longitudinals	Minimum of 3 longitudinals in each bay where bottom plating measured	3 measurements in line across flange and 3 measurements on vertical web
Bottom girders and brackets	At fore and aft transverse bulkhead, bracket toes and in centre of tanks	Vertical line of single measurements on web plating with one measurement between each panel stiffener, or a minimum of three measurements. Two measurements across face flat. 5-point pattern on girder/bulkhead brackets
Bottom transverse webs	3 webs in bays where bottom plating measured, with measurements at both ends and middle	5-point pattern over 2 square metre area. Single measurements on face flat
Panel stiffening	Where provided	Single measurements

Table 6 : Requirements for extent of thickness measurements at those areas of substantial corrosion on FPSO and FPU single hull units within the cargo area

DECK STRUCTURE		
Structural member	Extent of measurement	Pattern of measurement
Deck plating	Two bands across tank	Minimum of three measurements per plate per band
Deck longitudinals	Minimum of 3 longitudinals in each of two bays	3 measurements in line vertically on webs and 2 measurements on flange (if fitted)
Deck girders and brackets	At fore and aft transverse bulkhead, bracket toes and in centre of tanks	Vertical line of single measurements on web plating with one measurement between each panel stiffener, or a minimum of three measurements. Two measurements across face flat. 5-point pattern on girder/bulkhead brackets
Deck transverse webs	Minimum of 2 webs, with measurements at both ends and middle of span	5-point pattern over 2 square metre area. Single measurements on face flat
Panel stiffening	Where provided	Single measurements

Table 7 : Requirements for extent of thickness measurements at those areas of substantial corrosion on FPSO and FPU single hull units within the cargo area

SIDE SHELL AND LONGITUDINAL BULKHEADS		
Structural member	Extent of measurement	Pattern of measurement
Deckhead and bottom strakes and strakes in way of stringer platforms	Plating between each pair of longitudinals in a minimum of 3 bays	Single measurement
All other strakes	Plating between every third pair of longitudinals in same 3 bays	Single measurement
Longitudinals on deckhead and bottom strakes	Each longitudinal in same 3 bays	3 measurements across web and 1 measurement on flange
All other longitudinals	Every third longitudinal in same 3 bays	3 measurements across web and 1 measurement on flange
Longitudinal brackets	Minimum of 3 at top, middle and bottom of tank in same 3 bays	5-point pattern over area of bracket
Web frames and cross ties	3 webs with minimum of three locations on each web, including in way of cross tie connections	5-point pattern over approximately 2 square metre area, plus single measurements on web frame and cross tie face flats

Table 8 : Requirements for extent of thickness measurements at those areas of substantial corrosion on FPSO and FPU single hull units within the cargo area

TRANSVERSE BULKHEADS AND SWASH BULKHEADS		
Structural member	Extent of measurement	Pattern of measurement
Deckhead and bottom strakes, and strakes in way of stringer platforms	Plating between pair of stiffeners at three locations : approximately 1/4, 1/2 and 3/4 width of tank	5-point pattern between stiffeners over 1 metre length
All other strakes	Plating between pair of stiffeners at middle location	Single measurement
Strakes in corrugated bulkheads	Plating for each change of scantling at centre of panel and at flange of fabricated connection	5-point pattern over about 1 square metre of plating
Stiffeners	Minimum of three typical stiffeners	For web, 5-point pattern over span between bracket connections (2 measurements across web at each bracket connection and one at centre of span). For flange, single measurements at each bracket toe and at centre of span
Brackets	Minimum of three at top, middle and bottom of tank	5-point pattern over area of bracket
Deep webs and girders	Measurements at toe of bracket and at centre of span	For web, 5-point pattern over about 1 square metre. Three measurements across face flat
Stringer platforms	All stringers with measurements at both ends and middle	5-point pattern over 1 square metre of area plus single measurements near bracket toes and on face flats

Table 9 : Requirements for extent of thickness measurements at those areas of substantial corrosion on FPSO and FPU double hull units within the cargo area

BOTTOM, INNER BOTTOM AND HOPPER STRUCTURE		
Structural member	Extent of measurement	Pattern of measurement
Bottom, inner bottom and hopper structure plating	Minimum of three bays across double bottom tank, including aft bay Measurements around and under all suction bell mouths	5-point pattern for each panel between longitudinals and floors
Bottom, inner bottom and hopper structure longitudinals	Minimum of three longitudinals in each bay where bottom plating measured	Three measurements in line across flange and three measurements on vertical web
Bottom girders, including the watertight ones	At fore and aft watertight floors and in centre of tanks	Vertical line of single measurements on girder plating with one measurement between each panel stiffener, or a minimum of three measurements
Bottom floors, including the watertight ones	Three floors in bays where bottom plating measured, with measurements at both ends and middle	5-point pattern over two square metre area
Hopper structure web frame ring	Three floors in bays where bottom plating measured	5-point pattern over one square metre of plating. Single measurements on flange
Hopper structure transverse watertight bulkhead or swash bulkhead	<ul style="list-style-type: none"> • lower 1/3 of bulkhead 	<ul style="list-style-type: none"> • 5-point pattern over one square metre of plating
	<ul style="list-style-type: none"> • upper 2/3 of bulkhead 	<ul style="list-style-type: none"> • 5-point pattern over two square metre of plating
	<ul style="list-style-type: none"> • stiffeners (minimum of three) 	<ul style="list-style-type: none"> • For web, 5-point pattern over span (two measurements across web at each end and one at centre of span). For flange, single measurements at each end and centre of span
Panel stiffening	Where applicable	Single measurements

Table 10 : Requirements for extent of thickness measurements at those areas of substantial corrosion on FPSO and FPU double hull units within the cargo area

DECK STRUCTURE		
Structural member	Extent of measurement	Pattern of measurement
Deck plating	Two transverse bands across tank	Minimum of three measurements per plate per band
Deck longitudinals	Every third longitudinal in each of two bands with a minimum of one longitudinal	Three measurements in line vertically on webs and two measurements on flange (if fitted)
Deck girders and brackets (usually in cargo tanks only)	At fore and aft transverse bulkhead, bracket toes and in centre of tanks	Vertical line of single measurements on web plating with one measurement between each panel stiffener, or a minimum of three measurements. Two measurements across flange. 5-point pattern on girder/bulkhead brackets
Deck transverse webs	Minimum of two webs, with measurements at both ends and middle of span	5-point pattern over one square metre area. Single measurements on flange
Vertical web and transverse bulkhead in wing ballast tank (two metres from deck)	Minimum of two webs, and both transverse bulkheads	5-point pattern over one square metre area
Panel stiffening	Where applicable	Single measurements

Table 11 : Requirements for extent of thickness measurements at those areas of substantial corrosion on FPSO and FPU double hull units within the cargo area

STRUCTURE IN WING BALLAST TANKS		
Structural member	Extent of measurement	Pattern of measurement
Side shell and longitudinal bulkhead plating: <ul style="list-style-type: none"> • upper strake and strakes in way of horizontal girders • all other strakes 	<ul style="list-style-type: none"> • Plating between each pair of longitudinals in a minimum of three bays (along the tank) • Plating between every third pair of longitudinals in same three bays 	<ul style="list-style-type: none"> • Single measurement • Single measurement
Side shell and longitudinal bulkhead longitudinals on: <ul style="list-style-type: none"> • upper strake • all other strakes 	<ul style="list-style-type: none"> • Each longitudinal in same three bays • Every third longitudinal in same three bays 	<ul style="list-style-type: none"> • 3 measurements across web and 1 measurement on flange
Longitudinals - brackets	Minimum of three at top, middle and bottom of tank in same three bays	5-point pattern over area of bracket
Vertical web and transverse bulkheads (excluding deckhead area): <ul style="list-style-type: none"> • strakes in way of horizontal girders • other strakes 	<ul style="list-style-type: none"> • Minimum of two webs and both transverse bulkheads • Minimum of two webs and both transverse bulkheads 	<ul style="list-style-type: none"> • 5-point pattern over approx. two square metre area • two measurements between each pair of vertical stiffeners
Horizontal girders	Plating on each girder in a minimum of three bays	Two measurements between each pair of longitudinal girder stiffeners
Panel stiffening	Where applicable	Single measurements

Table 12 : Requirements for extent of thickness measurements at those areas of substantial corrosion on FPSO and FPU double hull units within the cargo area

LONGITUDINAL BULKHEADS IN CARGO TANKS		
Structural member	Extent of measurement	Pattern of measurement
Deckhead and bottom strakes, and strakes in way of the horizontal stringers of transverse bulkheads	Plating between each pair of longitudinals in a minimum of three bays	Single measurement
All other strakes	Plating between every third pair of longitudinals in same three bays	Single measurement
Longitudinals on deckhead and bottom strakes	Each longitudinal in same three bays	Threemeasurementsacrossweb and one measurement on flange
All other longitudinals	Every third longitudinal in same three bays	Threemeasurementsacrossweb and one measurement on flange
Longitudinals - brackets	Minimum of three at top, middle and bottom of tank in same three bays	5-point pattern over area of bracket
Web frames and cross ties	Three webs with minimum of three locations on each web, including in way of cross tie connections	5-point pattern over approximately two square metre area of webs, plus single measurements on flanges of web frame and crossties
Lower end brackets (opposite side of web frame)	Minimum of three brackets	5-point pattern over approximately two square metre area of brackets, plus single measurements on bracket flanges

Table 13 : Requirements for extent of thickness measurements at those areas of substantial corrosion on FPSO and FPU double hull units within the cargo area

TRANSVERSE WATERTIGHT AND SWASH BULKHEADS IN CARGO TANKS		
Structural member	Extent of measurement	Pattern of measurement
Upper and lower stool, where fitted	<ul style="list-style-type: none"> • Transverse band within 25mm of welded connection to inner bottom/deck plating • Transverse band within 25mm of welded connection to shelf plate 	5-point pattern between stiffeners over one metre length
Deckhead and bottom strakes, and strakes in way of horizontal stringers	Plating between pair of stiffeners at three locations : approximately 1/4, 1/2 and 3/4 width of tank	5-point pattern between stiffeners over one metre length
All other strakes	Plating between pair of stiffeners at middle location	Single measurement
Strakes in corrugated bulkheads	Plating for each change of scantling at centre of panel and at flange of fabricated connection	5-point pattern over about one square metre of plating
Stiffeners	Minimum of three typical stiffeners	For web, 5-point pattern over span between bracket connections (two measurements across web at each bracket connection and one at centre of span). For flange, single measurements at each bracket toe and at centre of span
Brackets	Minimum of three at top, middle and bottom of tank	5-point pattern over area of bracket
Horizontal stringers	All stringers with measurements at both ends and middle	5-point pattern over one square metre area, plus single measurements near bracket toes and on flanges

7.4.5 For areas in tanks where protective coatings are found to be in good condition as defined in Ch 2, Sec 2, [2.2.11], the extent of thickness measurements according to Tab 3 or Tab 4 may be specially considered.

7.4.6 Transverse sections are to be chosen where the largest reductions are suspected to occur or are revealed from deck plating measurements.

7.4.7 In cases where two or three sections are to be measured, at least one is to include a ballast tank within 0,5L amidships.

7.5 Tank testing

7.5.1 The requirements for tank testing at class renewal survey are given in Tab 14.

7.5.2 The Surveyor may extend the tank testing as deemed necessary.

7.5.3 Boundaries of ballast tanks are to be tested with a head of liquid to the top of air pipes.

7.5.4 Testing of boundaries of cargo tanks is to be carried out as agreed between the Society and Owners and reported in the planned survey program.

7.6 Cargo area and cargo pump rooms

7.6.1 Cargo piping on deck, including crude oil washing (cow) piping, and cargo and ballast piping within the cargo area are to be examined and operationally tested to working pressure to the attending Surveyor's satisfaction to ensure that their tightness and condition remain satisfactory. Special attention is to be given to any ballast piping in cargo tanks and cargo piping in ballast tanks and void spaces. Surveyors are to be advised on all occasions when this piping, including valves and fittings, is opened during repair periods and can be examined internally.

The surveyor may require dismantling and/or thickness measurements of piping. A hydraulic test is to be carried out in the event of repair or dismantling of cargo, crude oil washing, or ballast piping, or where doubts arise.

7.6.2 (15/12/2016)

All safety valves on cargo piping and of cargo tanks are to be dismantled for examination, adjusted and, as applicable, resealed.

Alternative methods, for the internal examination of the safety valves and their components and for the verification of their setting points, may be approved by the Society on a case by case basis.

7.6.3 All cargo pump room boundaries are to be generally examined. All gas-tight shaft sealing devices are to be examined. The bottom of cargo pump rooms is to be pre-

pared clean for the examination of stripping devices and gutters.

8 Class renewal survey - Cargo machinery items

8.1 Cargo area and cargo pump rooms

8.1.1 Ballast and stripping pumps are to be internally examined and prime movers checked. A working test is to be carried out, as far as practicable.

Maintenance records of cargo pumps are to be made available to the Surveyor.

8.1.2 Where a crude oil washing system is fitted, piping, pumps, valves and deck-mounted washing machines are to be examined and tested for signs of leakage, and anchoring devices of deck-mounted washing machines are to be checked to the Surveyor's satisfaction.

8.1.3 The satisfactory condition of the cargo heating system is to be verified and, if deemed necessary by the Surveyor, the system is to be pressure tested.

8.1.4 An operating test of the remote control of pumps and valves and of automatic closing valves is to be carried out.

8.1.5 A general examination of the electrical equipment and cables in dangerous zones such as cargo pump rooms and areas adjacent to cargo tanks is to be carried out for defective and non-certified safe type electrical equipment and fixtures, non-approved lighting and fixtures, and improperly installed or defective or dead-end wiring.

The electrical insulation resistance of the electrical equipment and circuits terminating in or passing through the dangerous zones is to be tested; however, in cases where a proper record of testing is maintained, consideration may be given to accepting recent test readings effected by the unit's personnel.

8.2 Inert gas system

8.2.1 In addition to the inspections required at the intermediate survey, the following is to be carried out:

- a) an internal examination of:
 - 1) the inert gas generator, where fitted
 - 2) the scrubber
 - 3) the deck water seal including the non-return valve
 - 4) the pressure/vacuum breaking device
 - 5) the cooling water systems including overboard discharge from the scrubber
 - 6) all valves
- b) a test to verify the proper operation of the system upon completion of all survey checks.

Table 14 : Requirements for tank testing at class renewal survey of FPSO and FPU units

Age of unit (in years at time of class renewal survey)	
age ≤ 5	age > 5
All ballast tank boundaries	All ballast tank boundaries
Cargo tank boundaries facing ballast tanks, void spaces, pipe tunnels, pump rooms or cofferdams	All cargo tank bulkheads

9 Class renewal survey - Production and process installations

9.1

9.1.1 The survey is to include the examination and test as necessary of the following components of the production and process installation:

- a) Major equipment of the production and process installation.
- b) Oil processing system.
- c) Production installation safety systems.
- d) Production installation utility systems.
- e) Relief and flare system.
- f) Well control system.

9.1.2 Pressure vessels forming part of the production and process installation are to be examined internally and externally. Principal mountings, supports and attachments to pressure vessels are to be examined.

9.1.3 Where pressure vessels are so constructed that internal inspection is prevented by normal means, agreed tests are to be carried out to the satisfaction of the Surveyor.

9.1.4 (15/12/2016)

Selected pressure safety valves are to be bench tested in accordance with a planned procedure for maintenance and inspection of the production and process installation. The Surveyor is to confirm that all pressure safety valves forming part of the production and process are examined and bench tested within each class renewal survey cycle.

Alternative methods, for the internal examination of the safety valves and their components and for the verification of their setting points, may be approved by the Society on a case by case basis.

SECTION 4

FSRU

1 General

1.1 Application

1.1.1 The requirements of this Section apply to all units which have been assigned the service notations **FSRU**.

1.1.2 The requirements apply to the surveys of the hull structure and piping systems in way of pump rooms, compressor rooms, cofferdams, pipe tunnels, void spaces and fuel oil tanks within the cargo area and all ballast tanks. These provisions are additional to the classification requirements applicable to the remainder of the unit, given in Chapter 3 according to the relevant surveys.

1.1.3 The requirements contain the minimum extent of examination, thickness measurements and tank testing. The survey is to be extended when substantial corrosion and/or structural defects are found and is to include additional close-up surveys when necessary.

2 Annual survey - Hull items

2.1 Scope

2.1.1 General

The survey is to consist of an examination for the purpose of ensuring, as far as practicable, that the hull and piping are maintained in a satisfactory condition.

2.1.2 Examination of the hull

- a) Examination of the hull plating and its closing appliances as far as can be seen.
- b) Examination of watertight penetrations as far as practicable.

2.1.3 Examination of weather decks

- a) Examination of flame screens on vents to all bunker tanks.
- b) Examination of bunker and vent piping systems.

2.1.4 Examination of cargo pump rooms and compressor rooms and, as far as practicable, pipe tunnels if fitted

- a) Examination of all pump room and compressor room bulkheads for signs of leakage or fractures and, in par-

ticular, the sealing arrangements of all penetrations of pump room and compressor room bulkheads.

- b) Examination of the condition of all piping systems, except those related to cargo installations, for which reference is to be made to [3.2] and [3.3].

Note 1: For survey of air pipes, flame screens on vents and ventilators, refer to the requirements given in Ch 3, Sec 3, [3.1.1].

2.1.5 Suspect areas

Suspect areas identified at previous surveys are to be examined. Thickness measurements are to be taken of the areas of substantial corrosion and the extent of thickness measurements is to be increased to determine the extent of areas of substantial corrosion.

Tab 4 may be used as guidance for these additional thickness measurements. These extended thickness measurements are to be carried out before the annual survey is credited as completed.

2.1.6 Examination of ballast tanks

Examination of ballast tanks is to be carried out when required as a consequence of the results of the class renewal survey and intermediate survey. When considered necessary by the Surveyor, or where extensive corrosion exists, thickness measurement is to be carried out. If the results of these thickness measurements indicate that there is substantial corrosion, then the extent of measurements is to be increased to determine the extent of areas of substantial corrosion. Tab 4 may be used as guidance for these additional measurements. These extended thickness measurements are to be carried out before the annual survey is credited as completed.

3 Annual survey - Cargo installations items

3.1 General

3.1.1 Method of survey

The annual survey of cargo installations is preferably to be carried out during a loading or discharging operation. Access to cargo tanks or inerted hold spaces, necessitating gas-freeing/aerating will normally not be necessary.

3.1.2 Check of cargo log book

Gas plant operational record (log) entries since the last survey are to be examined in order to check the past performance of the system and to establish whether certain parts have shown any irregularities in operation. The evaporation rate and the inert gas consumption are also to be considered.

3.2 Weather decks and cargo handling rooms

3.2.1 The survey is to include:

- a) examination of all accessible gas-tight bulkhead penetrations including gas-tight shaft sealings
- b) examination of the sealing arrangements for tanks or tank domes penetrating decks or tank covers
- c) examination of vapour and gas tightness devices of the wheelhouse windows and doors, sidescuttles and windows in way of ends of superstructures and deckhouses facing the cargo area or bow or stern loading/unloading arrangements, and closing devices of air intakes and openings into accommodation, service and machinery spaces and control stations
- d) examination of cargo and process piping, including the expansion arrangements, insulation from the hull structure, pressure relief and drainage arrangements
- e) examination of venting systems, including vent masts and protective screens, for cargo tanks, interbarrier spaces, hold spaces, fuel tanks and ballast tanks
- f) examination of cargo tank and interbarrier space relief valves and associated safety systems and alarms
- g) confirmation that the certificate for the relief valve opening/closing pressures is onboard
- h) examination of drip trays or insulation for deck protection against cargo leakage
- i) examination of the cargo pump room, cargo compressor room and cargo control room
- j) confirmation of proper maintenance of arrangements for the airlocks
- k) confirmation that all accessible cargo piping systems are electrically bonded to the hull.

3.3 Other arrangements or devices

3.3.1 The survey is to include:

- a) confirmation that the unit's cargo hoses are suitable for their intended purpose and in satisfactory condition
- b) confirmation that any special arrangement made for bow or stern loading/unloading is satisfactory
- c) confirmation that relevant instruction and information material such as cargo handling plans, filling limit information, cooling down procedures, etc. is on board
- d) confirmation that, if applicable, the provisions made for products which have special arrangements are satisfactory.

3.4 Cargo area, cargo compressor rooms, cargo pump rooms

3.4.1 The survey is to include:

- a) examination of mechanical ventilation fans in gas-dangerous spaces and zones
- b) examination and confirmation of the satisfactory operation of mechanical ventilation of spaces normally entered during operation
- c) examination, as far as possible during operation, of cargo heat exchangers, vaporisers, pumps, compressors and hoses
- d) confirmation that fixed and/or portable ventilation arrangements provided for spaces not normally entered are satisfactory
- e) examination of the gas detection safety arrangements for cargo control rooms and of the measures taken to exclude ignition sources when such spaces are not gas-safe
- f) examination of cargo (if accessible), bilge, ballast and stripping pumps for excessive gland seal leakage
- g) confirmation that electrical equipment in gas-dangerous spaces and zones is in satisfactory condition and has been properly maintained
- h) examination, as far as possible, of arrangements for the use of cargo as fuel, and associated instrumentation and safety devices
- i) confirmation that, if fitted, cargo reliquefaction or refrigeration equipment is in satisfactory condition.

3.5 Instrumentation and safety devices

3.5.1 The survey is to include:

- a) confirmation that installed pressure gauges on cargo discharge lines are operational (see Note 1)
- b) confirmation that cargo tank liquid level gauges are operational and that high level alarms as well as automatic shut-off systems are satisfactory (see Note 1)
- c) confirmation that the temperature indicating equipment of the cargo containment system and associated alarms are satisfactory (see Note 1)
- d) examination of the log-books for confirmation that the emergency shutdown system has been tested
- e) confirmation that cargo tank, hold and insulation space pressure gauging systems and associated alarms are satisfactory
- f) examination, and testing as appropriate, of fixed gas detection equipment
- g) confirmation of the availability and suitability of the portable gas detection equipment and instruments for measuring oxygen levels.

Note 1: Verification of these devices is to be carried out by one or more of the following methods:

- visual external examination
- comparing of read-outs from different indicators
- consideration of read-outs with regard to the actual cargo and/or actual conditions
- examination of maintenance records with reference to the cargo plant instrumentation maintenance manual
- verification of calibration status of the measuring instruments.

3.6 Inert gas/air drying systems

3.6.1 The survey is to include:

- a) the examinations and tests as provided for the annual survey of inert gas systems of FPSO and FSO, given in [3.3]
- b) confirmation that arrangements are made for sufficient inert gas to be carried to compensate for normal losses and that means are provided for monitoring the spaces
- c) confirmation that the means for prevention of backflow of cargo vapour to gas-safe spaces are in satisfactory operating condition
- d) confirmation that any air drying system and any inter-barrier and hold space purging inert gas system are satisfactory
- e) for membrane containment systems, confirmation by the Master to the Surveyor of the normal operation of the nitrogen control system for insulation and interbarrier spaces.

4 Intermediate survey - Hull items

4.1 Scope

4.1.1 The extent of the survey is dependent on the age of the vessel as specified in [4.1.2].

4.1.2 Ballast tanks

- a) For units between 5 and 10 years of age, an overall survey of representative ballast tanks is to be carried out. If there is no hard protective coating, or if there is soft or semi-hard coating or poor coating condition, the examination is to be extended to other ballast tanks of the same type.
- b) For units over 10 years of age, an overall survey of all ballast tanks is to be carried out.
- c) If such examinations reveal no visible structural defects, the examination may be limited to verification that the corrosion prevention system remains efficient.
- d) For ballast tanks, excluding double bottom tanks, if there is no hard protective coating, or if there is soft or semi-hard coating, or poor coating condition and it is not renewed, the tanks in question are to be internally examined at annual intervals.
- e) When such conditions are found in double bottom ballast tanks, the tanks in question may be internally examined at annual intervals.
- f) The minimum requirements for close-up surveys at intermediate survey are given in Tab 1.

Table 1 : Minimum requirements for close-up survey at hull intermediate surveys of FSRU

Age of unit (in years at time of intermediate survey)	
10 < age ≤ 15	age > 15
Close-up survey of: a) all web frames and both transverse bulkheads in a representative ballast tank (1) and (2) b) the upper part of one web frame in another representative ballast tank c) one transverse bulkhead in another representative ballast tank (2)	Close-up survey of: a) all web frames and both transverse bulkheads in two representative ballast tanks (1) and (2)
(1) Complete transverse web frame including adjacent structural members (2) Transverse bulkhead complete, including girder system and adjacent members, and adjacent longitudinal bulkhead structure Note 1: Ballast tanks include topside, double hull side, double bottom, hopper side, or any combined arrangement of the aforementioned, and peak tanks where fitted. Note 2: For areas in tanks where protective coating is found to be in good condition, the extent of close-up survey may be specially considered by the Society. Note 3: For units having independent tanks of type C, with a midship section similar to that of a general cargo ship, the extent of close-up surveys may be specially considered by the Society. Note 4: The extent of close-up surveys may be extended by the Surveyor as deemed necessary, taking into account the maintenance of the tanks under survey, the condition of the corrosion prevention system and also in the following cases: a) in particular, in tanks having structural arrangements or details which have suffered defects in similar tanks, or on similar units according to available information; b) in tanks having structures approved with reduced scantlings.	

5 Intermediate survey - Cargo installation items

5.1 General

5.1.1 Aim of survey

The aim of the intermediate survey is to supplement the annual survey by testing cargo handling installations with related automatic control, alarm and safety systems for correct functioning.

5.1.2 Method of survey

The intermediate survey is preferably to be carried out with the unit in a gas-free condition. In fact, the extent of the testing required for the intermediate survey will normally be such that the survey cannot be carried out during a loading or discharging operation.

5.2 Weather decks and cargo handling rooms

5.2.1 The survey is to include:

- a) examination, as far as applicable, of cargo and process, liquid nitrogen (if any), ballast, bunker, stripping and vent piping systems as well as vent masts and headers. If upon examination there is any doubt as to the condition of the piping, pressure testing, thickness measurement or both may be required
- b) examination of vent line drainage arrangements
- c) confirmation that cargo pipes and independent cargo tanks, where applicable, are electrically bonded to the hull.

5.3 Cargo area, cargo pump rooms, cargo compressor rooms

5.3.1 Electrical equipment and cables in dangerous zones such as cargo pump rooms, cargo compressor rooms and spaces adjacent to and areas above cargo tanks are to be examined as far as practicable and tested with particular regard to:

- a) protective earthing (spot check)
- b) integrity of enclosures
- c) damage of outer sheath of cables
- d) function test of pressurised equipment and associated alarms
- e) test of systems for de-energising non-certified safe electrical equipment located in spaces protected by airlocks, such as electric motor rooms, cargo control rooms, etc.

5.3.2 The electrical insulation resistance of the electrical equipment and circuits in dangerous zones is to be meas-

ured. These measurements are only to be effected when the unit is in a gas-free or inerted condition. Where a proper record of testing is maintained, consideration may be given to accepting recent readings by the unit's personnel.

Reference is also to be made to IACS Recommendation No. 35 - Inspection and maintenance of electrical equipment installed in hazardous areas.

Note 1: It is advisable that the electrical insulation resistance is measured when the unit is in a gas-free or inerted condition.

5.3.3 In addition to the requirements of [5.3.1] and [5.3.2], the survey also consists of:

- a) confirmation that the cargo heating/cooling system is in satisfactory condition
- b) confirmation that the heating system of the hull structure is in satisfactory working condition, as applicable
- c) general examination and test of leakage detection systems in interbarrier and hold spaces.

5.4 Instrumentation and safety devices

5.4.1 The survey is to include:

- a) examination of the installed pressure gauging systems on cargo discharge lines, cargo tanks, holds and insulation spaces and associated alarms
- b) examination of the cargo tank liquid level gauges and high level alarms as well as automatic shut-off systems
- c) examination of the temperature indicating equipment of the cargo containment system and associated alarms
- d) test of the above-mentioned instrumentation by changing pressure, level and temperature as applicable and comparing with test instruments. Simulated tests may be accepted for sensors which are not accessible or located within cargo tanks or inerted hold spaces. The test is to include alarm and safety functions
- e) examination, as far as practicable, of the piping of the gas detection system for corrosion and damage. The integrity of the suction lines between suction points and analysing units is to be verified as far as possible
- f) calibration of gas detectors or verification thereof with sample gases
- g) confirmation of the availability and suitability of the portable gas detection equipment and instruments for measuring oxygen levels
- h) test of the manually operated emergency shutdown system (without flow in the pipelines) to verify that the system will cause the cargo pumps and compressors to stop.

5.4.2 The instrumentation and safety systems for burning cargo as fuel are to be examined in accordance with the requirements indicated in [5.4.1].

5.5 Inert gas system

5.5.1 For units over 10 years old at the time of the intermediate survey due date, if an inert gas system such as that installed on board FPSO or FSO is fitted, the requirements given in [5.2] for intermediate survey of oil tankers are to be complied with.

5.5.2 In the case of low temperature liquid nitrogen storage, the plant and its associated arrangements for protecting the hull structure against liquid nitrogen leakage are to be examined..

6 Class renewal survey - Hull items

6.1 Planned survey program

6.1.1 The class renewal survey is to be carried out in accordance with the planned survey program indicated in Ch 2, Sec 2, [2.12].

6.2 Scope of survey

6.2.1 General

In addition to the requirements of annual surveys, the class renewal survey is to include examination, tests and checks of sufficient extent to ensure that the hull and related piping, as required in [6.2.3], are in satisfactory condition and fit for the intended purpose for the new period of class of 5 years to be assigned, subject to proper maintenance and operation and to periodical surveys being carried out at the due dates.

6.2.2 Tanks, spaces and areas

Ballast tanks, including double bottom tanks, pump rooms, compressor rooms, pipe tunnels, cofferdams and void spaces bounding cargo tanks, decks and outer hull are to be examined, and this examination is to be supplemented by thickness measurement and testing, as required in [6.4] and [6.5], to ensure that the structural integrity remains effective.

The aim of the examination is to discover substantial corrosion, significant deformation, fractures, damage or other structural deterioration that may be present.

6.2.3 Piping

All piping systems within the above spaces, except those related to cargo installations, for which reference is to be made to [7.3], are to be examined and operationally tested to working pressure to the attending Surveyor's satisfaction to ensure that tightness and condition remain satisfactory.

6.2.4 Ballast tanks converted to void spaces

The extent of the survey of ballast tanks converted to void spaces is to be specially considered in relation to the requirements for ballast tanks.

Note 1: For survey of automatic air pipes, refer to Ch 3, Sec 5, [2.2.4].

Note 2: For examination of automatic air pipe heads, reference is to be made to the requirements given in Ch 3, Sec 5, Tab 4.

6.2.5 Ballast tank protection

The condition of the corrosion prevention system of ballast tanks, where provided, is to be examined.

For tanks used for water ballast, excluding double bottom tanks, where a hard protective coating is found in poor condition and it is not renewed, where soft or semi-hard coating has been applied, or where a hard protective coating has not been applied since the time of construction, the tanks in question are to be examined at annual surveys. Thickness measurements are to be carried out as deemed necessary by the Surveyor.

When such breakdown of hard protective coating is found in water ballast double bottom tanks and it is not renewed, where a soft or semi-hard coating has been applied, or where a hard protective coating has not been applied since the time of construction, the tanks in question may be examined at annual surveys. When considered necessary by the Surveyor, or where extensive corrosion exists, thickness measurements are to be carried out.

6.2.6 Special consideration

Where the hard protective coating in ballast tanks is found to be in a good condition, the extent of close-up surveys and thickness measurements may be specially considered.

6.3 Extent of overall and close-up surveys

6.3.1 Overall surveys

An overall survey of all tanks and spaces, excluding fuel oil, lube oil and fresh water tanks, is to be carried out at each class renewal survey.

Note 1: For fuel oil, lube oil and fresh water tanks, reference is to be made to the requirements given in Ch 3, Sec 5, [2.4.1].

6.3.2 Close-up surveys

The minimum requirements for close-up surveys at class renewal survey are given in Tab 2.

6.3.3 Expansion of close-up surveys

The Surveyor may extend the close-up survey as deemed necessary taking into account the maintenance of the tanks under survey, the condition of the corrosion prevention system and where tanks have structural arrangements or details which have suffered defects in similar spaces or on similar units according to available information.

6.3.4 Special consideration

For areas in tanks where hard protective coatings are found to be in a good condition, the extent of close-up surveys according to Tab 2 may be specially considered.

6.4 Extent of thickness measurements

6.4.1 Minimum requirements

The minimum requirements for thickness measurements at class renewal survey are given in Tab 3.

6.4.2 Expansion of thickness measurements

The Surveyor may extend the thickness measurements as deemed necessary. When thickness measurements indicate substantial corrosion, the extent of such measurements is to be increased to determine the extent of areas of substantial

corrosion. Tab 4 may be used as guidance for these additional thickness measurements.

6.4.3 Special consideration

For areas in tanks where hard protective coatings are found to be in a good condition, the extent of thickness measurement according to Tab 3 may be specially considered.

6.4.4 Choice of transverse sections

Transverse sections are to be chosen where the largest reductions are suspected to occur or are revealed from deck plating measurements.

6.5 Extent of tank testing

6.5.1 Testing requirements

All boundaries of water ballast tanks and deep tanks used for water ballast within the cargo area are to be pressure

tested. For fuel oil tanks, representative tanks are to be pressure tested.

6.5.2 Expansion of tank testing

The Surveyor may extend the tank testing as deemed necessary.

6.5.3 Method of tank testing

Tank testing of fuel oil tanks is to be carried out with a head of liquid to the highest point that liquid will rise to under service conditions. Tank testing of fuel oil tanks may be specially considered based on a satisfactory external examination of the tank boundaries, and a confirmation from the Master stating that the pressure testing has been carried out according to the requirements with satisfactory results.

Table 2 : Minimum requirements for close-up survey at class renewal surveys of FSRU

Age of unit (in years at time of class renewal survey due date)		
age ≤ 5	5 < age ≤ 10	age > 10
One web frame in a representative ballast tank of the topside, hopper side and double hull side type (1) One transverse bulkhead in a ballast tank (3)	All web frames in a ballast tank, which is to be a double hull side tank or a topside tank. If such tanks are not fitted, another ballast tank is to be selected (1) One web frame in each remaining ballast tank (1) One transverse bulkhead in each ballast tank (2)	All web frames in all ballast tanks (1) All transverse bulkheads in all ballast tanks (2)
<p>(1) Complete transverse web frame including adjacent structural members (2) Transverse bulkhead complete, including girder system and adjacent members, and adjacent longitudinal bulkhead structure (3) Transverse bulkhead lower part including girder system and adjacent structural members Note 1: Ballast tanks include topside, double hull side, double bottom, hopper side, or any combined arrangement of the aforementioned, and peak tanks where fitted. Note 2: For areas in tanks where coatings are found to be in good condition, as defined in Ch 2, Sec 2, [2.2.11], the extent of close-up surveys may be specially considered by the Society. Note 3: For units having independent tanks of type C, with a midship section similar to that of a general cargo ship, the extent of close-up surveys may be specially considered by the Society. Note 4: The Surveyor may extend the close-up survey as deemed necessary, taking into account the maintenance of the tanks under survey, the condition of the corrosion prevention system and also in the following cases:</p> <p>a) in particular, in tanks having structural arrangements or details which have suffered defects in similar tanks, or on similar units according to available information; b) in tanks having structures approved with reduced scantlings.</p>		

Table 3 : Minimum requirements for thickness measurements at class renewal surveys of FSRU

Age of unit (in years at time of class renewal survey due date)			
age ≤ 5	5 < age ≤ 10	10 < age ≤ 15	age > 15
Suspect areas	Suspect areas	Suspect areas	Suspect areas
One section of deck plating for the full beam of the unit within 0,5 L amidships in way of a ballast tank, if any	Within the cargo area: <ul style="list-style-type: none"> each deck plate b) one transverse section within 0,5 L amidships in way of a ballast tank, if any 	Within the cargo area: <ul style="list-style-type: none"> each deck plate two transverse sections (1) all wind and water strakes 	Within the cargo area: <ul style="list-style-type: none"> each deck plate three transverse sections (1) each bottom plate duct keel plating and internals
	Selected wind and water strakes outside the cargo area	Selected wind and water strakes outside the cargo area	All wind and water strakes, full length
Measurements, for general assessment and recording of corrosion pattern, of those structural members subject to close-up survey according to Tab 2	Measurements, for general assessment and recording of corrosion pattern, of those structural members subject to close-up survey according to Tab 2	Measurements, for general assessment and recording of corrosion pattern, of those structural members subject to close-up survey according to Tab 2	Measurements, for general assessment and recording of corrosion pattern, of those structural members subject to close-up survey according to Tab 2
<p>(1) At least one section is to be within 0,5 L amidships and, where applicable, in way of a ballast tank.</p> <p>Note 1: For units having independent tanks of type C, with a midship section similar to that of a general cargo ship, the extent of thickness measurements may be increased to include the tank top plating at the discretion of the Surveyor.</p> <p>Note 2: For areas in spaces where coatings are found to be in good condition, the extent of thickness measurements may be specially considered by the Society.</p> <p>Note 3: The Surveyor may extend the thickness measurements as deemed necessary. When thickness measurements indicate substantial corrosion, the extent of such measurements is to be increased to determine the extent of areas of substantial corrosion. Sec 6, Tab 4 may be used as guidance for these additional thickness measurements.</p>			

Table 4 : Guidance for additional thickness measurements in way of substantial corrosion of FSRU

Structural member	Extent of Measurement	Pattern of Measurement
Plating	Suspect area and adjacent plates	5-point pattern over 1 square metre
Stiffeners	Suspect area	3 measurements each in line across web and flange

7 Class renewal survey - Cargo installation items

7.1 General

7.1.1 The requirements of intermediate survey apply with the following additions.

7.2 Cargo containment

7.2.1 Cleaning and examination of tanks

All cargo tanks are to be cleaned and examined internally.

7.2.2 Insulation and cold spots

When accessible, the outer surface of uninsulated cargo tanks or the outer surface of cargo tank insulation together with any vapour or protective barrier is to be examined. Special attention is to be given to the cargo tank and insula-

tion in way of chocks, supports and keys. Removal of insulation may be required in order to verify the condition of the tank or the insulation itself if found necessary by the Surveyor.

Where the arrangement is such that the insulation cannot be examined, the surrounding structures of wing tanks, double bottom tanks and cofferdams are to be examined for cold spots when the cargo tanks are in the cold condition unless voyage records together with the instrumentation give sufficient evidence of the integrity of the insulation system.

7.2.3 Non-destructive testing

Non-destructive testing is to supplement cargo tank inspection with special attention to be given to the integrity of the main structural members, tank shell and highly stressed parts, including welded connections as deemed necessary

by the Surveyor. The following items are, inter alia, considered highly stressed parts:

- a) cargo tank supports and anti-rolling/anti-pitching devices,
- b) web frames or stiffening rings,
- c) Y-connections between tank shell and a longitudinal bulkhead of bilobe tanks,
- d) swash bulkhead boundaries,
- e) dome and stump connections to tank shell,
- f) foundations for pumps, towers, ladders, etc.,
- g) pipe connections.

Where the tanks are to be hydraulically tested in accordance with [7.2.7], non-destructive testing is to be carried out after the hydraulic testing.

7.2.4 Type B tanks

For independent tanks of type B, the extent of non-destructive testing is to be as given in a program specially prepared for the cargo tank design.

7.2.5 Tightness of tanks

The tightness of all cargo tanks is to be verified by an appropriate procedure. Provided that the effectiveness of the unit's gas detection equipment has been confirmed, it will be acceptable to utilise this equipment for the tightness test of independent tanks below deck.

7.2.6 Hydraulic or hydro-pneumatic test

Where the results of the examinations dealt with in [7.2.1] to [7.2.5] or the examination of the voyage records raise doubts as to the structural integrity of a cargo tank, a hydraulic or hydro-pneumatic test is to be carried out.

For integral tanks and for independent tanks of type A and B, the test pressure is to be not less than the MARVS.

For independent tanks of type C, the test pressure is to be not less than 1,25 times the MARVS.

7.2.7 Type C tanks

When the unit is 10 years old and thereafter at every alternate class renewal survey, independent cargo tanks of type C are to be either:

- a) hydraulically tested to 1,25 times the MARVS, and thereafter non-destructively tested in accordance with [7.2.3], or
- b) subjected to thorough non-destructive testing in accordance with a program specially prepared for the tank design. If a special program of non-destructive testing does not exist, special attention is to be given to the detection of surface cracks in welded connections in highly stressed areas as listed in [7.2.3]. At least 10% of the length of the welded connections in each of the above-mentioned areas is to be tested. This testing is to be carried out internally and externally, as applicable. Insulation is to be removed as necessary for the required non-destructive testing.

7.2.8 Hold spaces and secondary barriers

As far as accessible, all hold spaces and hull insulation (if provided), secondary barriers and tank supporting structures are to be visually examined. The secondary barrier of tanks is to be checked for its effectiveness by means of a pressure/vacuum test, a visual examination or any other acceptable method.

7.2.9 Membrane and semi-membrane systems

- a) For membrane and semi-membrane tanks systems, inspection and testing are to be carried out in accordance with programs specially prepared in accordance with an approved method for the actual tank system.
- b) For membrane containment systems, a tightness test of the secondary barrier is to be carried out in accordance with the system Designers' procedures as approved by the Society.
- c) For membrane containment systems with glued secondary barriers, the values obtained are to be compared with previous results or results obtained at new building stage. If significant differences are observed for each tank or between tanks, the Surveyor will require an evaluation and additional testing as necessary.

7.2.10 Gas-tight bulkheads

All gas-tight bulkheads are to be examined and the effectiveness of gas-tight shaft sealing is to be verified.

7.2.11 Tanks electrically bonded

It is to be verified that independent cargo tanks are electrically bonded to the hull.

7.2.12 Pressure relief valves

Pressure relief valves for cargo tanks are to be opened for examination, adjusted, function tested and sealed. If the cargo tanks are equipped with relief valves with non-metallic membranes in the main or pilot valves, these non-metallic membranes are to be replaced. Where a proper record of continuous overhaul and re-testing of individually identifiable relief valves is maintained, consideration may be given to acceptance on the basis of opening, internal examination and testing of a representative sample of valves, including each size and type of liquefied gas or vapour relief valves in use, provided there is evidence in the log-book that the remaining valves have been overhauled and tested since crediting of the previous class renewal survey.

7.2.13 Pressure/vacuum relief valves

Pressure/vacuum relief valves, rupture disc and other pressure relief devices for interbarrier spaces and hold spaces are to be opened, examined, tested and readjusted as necessary, depending on their design.

7.3 Piping systems

7.3.1 Cargo, liquid nitrogen (if any), process, stripping and venting piping systems, including valves, actuators, compensators, etc. are to be opened for examination as deemed necessary. Insulation is to be removed as deemed necessary to ascertain the condition of the pipes. If the visual examination raises doubt as to the integrity of the pipelines, a pressure test at 1,25 times the MARVS for the pipeline is to

be carried out. After reassembly the complete piping systems are to be tested for leaks.

7.3.2 It is to be verified that all cargo piping systems are electrically bonded to the hull.

7.3.3 Pressure relief valves on cargo piping are to be function tested. A random selection of valves is to be opened for examination and adjusted.

7.3.4 Vent line drainage arrangements are to be examined.

7.4 Cargo area, cargo pump rooms, cargo compressor rooms

7.4.1 Examination of spaces

All cargo pump room, compressor room and control room boundaries are to be generally examined. Gas-tight shaft sealing devices are to be examined. The bottom of cargo pump rooms and cargo compressor rooms is to be presented clean for the examination of stripping devices and gutters.

7.4.2 Examination of pumps

Ballast and stripping pumps are to be internally examined and prime movers checked. A working test is to be carried out.

Maintenance records of cargo pumps are to be made available to the Surveyor.

7.4.3 Electrical equipment in dangerous zones

Electrical equipment and cables in dangerous zones such as cargo pump rooms, cargo compressor rooms and spaces adjacent to and areas above cargo tanks are to be examined as far as practicable and tested with particular regard to:

- a) protecting earthing (spot check)
- b) integrity of enclosures
- c) damage of outer sheath of cables
- d) function testing of pressurised equipment and associated alarms
- e) testing of systems for de-energising non-certified safe electrical equipment located in spaces protected by airlocks, such as electric motor rooms, cargo control rooms, etc.

7.4.4 Measurement of electrical insulation

The electrical insulation resistance of the electrical equipment and circuits in dangerous zones is to be measured. These measurements are only to be effected when the unit

is in a gas-free or inerted condition. Where a proper record of testing is maintained, consideration may be given to accepting recent readings by the unit's personnel.

Reference is also to be made to IACS Recommendation No. 35 - Inspection and maintenance of electrical equipment installed in hazardous areas.

Note 1: It is advisable that the electrical insulation resistance is measured when the unit is in a gas-free or inerted condition.

7.4.5 Reliquefaction or refrigeration plants, arrangements for the use of cargo as fuel

When there is a reliquefaction or refrigeration plant, and/or arrangements for the use of cargo as fuel, the corresponding machinery and equipment, such as cargo pumps, compressors, heat exchangers, condensers, liquid nitrogen tanks, process pressure vessels and other components, are to be surveyed to the same extent as required for similar equipment on board FSO or FPSO at the class renewal survey (refer to Sec 2 or Sec 3).

7.4.6 Additional examinations

In addition to the requirements of [7.4.1] to [7.4.5], the survey also consists of:

- a) confirmation that the installation for heating the hull structure is in satisfactory working condition
- b) general examination and testing of leakage detection systems in interbarrier spaces and hold spaces
- c) examination of the gas detection piping system for corrosion or damage; checking, as far as possible, of the integrity of suction lines between suction points and analysing units
- d) examination and tests of systems for the removal of water from interbarrier spaces and hold spaces
- e) examination of portable equipment, such as hoses and spool pieces used for segregation of piping systems for cargo, inert gas and bilge pumping.

7.5 Inert gas system/air drying system

7.5.1 If an inert gas system such as that installed on board FSO or FPSO is fitted, the requirements given in [7.2] are to be complied with.

7.5.2 In the case of low temperature liquid nitrogen storage, the plant and its associated arrangements for protecting the hull structure against liquid nitrogen leakage are to be examined.

Figure 1 : Typical midship sections of FSRU (LNG or LPG)

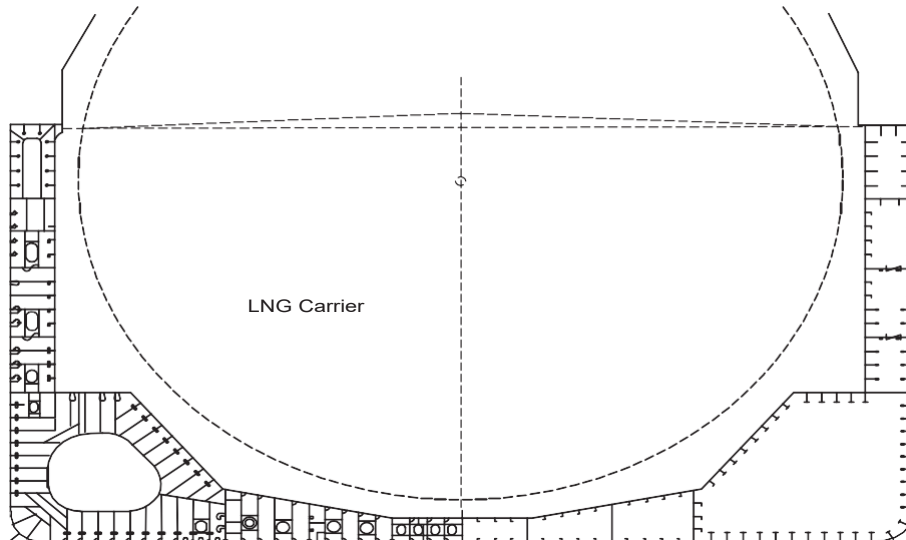

Figure 2

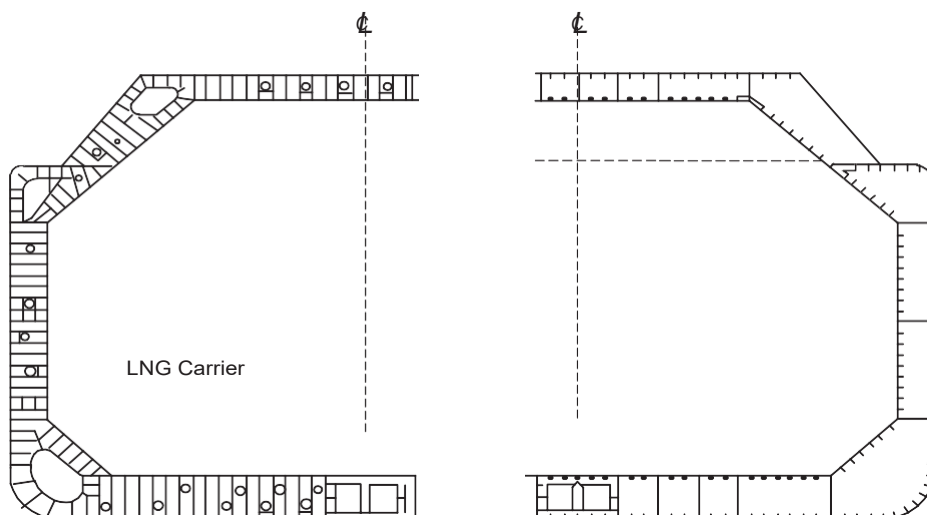

Figure 3

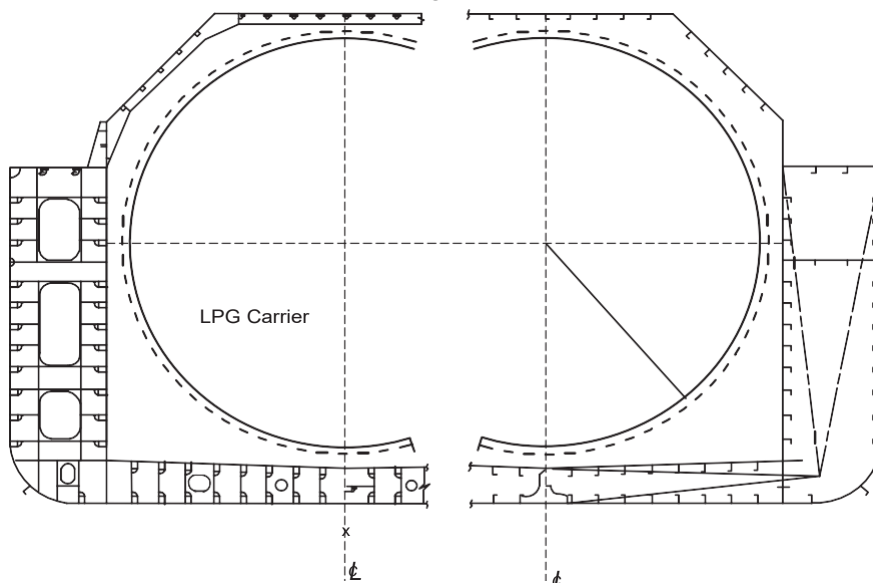
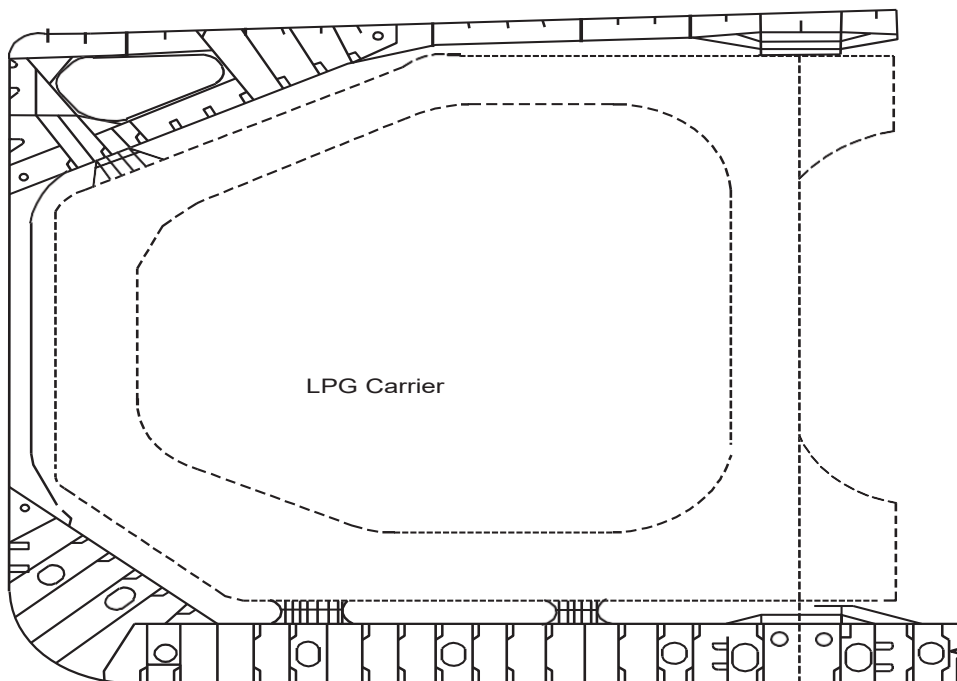

Figure 4



SECTION 5

MODU

1 General

1.1 Application

1.1.1 The requirements of this Section apply to all floating offshore units which have been assigned the service notations MODU.

1.1.2 The requirements for hull surveys apply to the surveys of the hull structure and piping systems in way of cargo tanks, pump rooms, cofferdams, pipe tunnels and void spaces within the cargo area and all salt water ballast tanks. They are additional to the requirements applicable to the remainder of the unit, given in Chapter 3 according to the relevant surveys.

1.1.3 The requirements contain the minimum extent of examination, thickness measurements and tank testing. When substantial corrosion, as defined in Ch 2, Sec 2, [2.2.7], and/or structural defects are found, the survey is to be extended and is to include additional close-up surveys when necessary.

1.1.4 The requirements for machinery surveys apply to surveys of the machinery and equipment in the cargo area or dedicated to cargo service systems and are additional to those given in Chapter 3 for all units.

2 Annual survey - Hull items

2.1 Hull, structure and weather decks

2.1.1 The survey may be carried out with the unit in operating conditions.

2.1.2 (1/1/2016)

The survey is to include:

- confirmation that bridge deck doors and windows, sidescuttles and windows in superstructure and deck-house ends facing the deck area are in satisfactory condition
- confirmation that the exposed parts of the hull, deck, deckhouses, superstructures and structures attached to the deck, derrick substructures, crane pedestals, including supporting structure, accessible internal spaces, and the applicable parts listed in Ch 3, Sec 3, [3.1.1] are in satisfactory condition
- examination, as far as possible, of systems and arrangements used for corrosion control (e. g. coatings,

cathodic protection systems, impressed current protection systems)

- confirmation that no material alterations have been made to the unit, its structural arrangements, subdivision, superstructure, fittings, and closing appliances upon which the stability calculations is based.

2.1.3 MODU surface units

In addition to the items above, the following is to be examined.

The hull and deck structure around the drilling well (moon-pool) and in vicinity of any other structural changes in section, slots, steps, or openings in the deck or hull and the back-up structures in way of structural members or spars connecting to the hull.

2.1.4 MODU self-elevating units

In addition to the items above, the following is to be examined.

- a) jack-house structures and attachments to upper hull or platform
- b) jacking or other elevating systems and leg guides, externally
- c) legs as accessible above the waterline
- d) plating and supporting structure in way of leg wells
- e) drilling derrick support structure.

At the first annual survey after construction, for self-elevating units non-destructive tests may be required for welded joints particularly prone to stress concentration and fatigue, as deemed necessary by the Society on the basis of results of the new building survey or admission to class survey. The extent of the above mentioned examinations, when required, is to be agreed to by the Society and the Owner or operator prior to commencement of the Survey.

2.1.5 MODU column-stabilized units

In addition to the items above, the following is to be examined.

- Columns, diagonal and horizontal braces together with any other parts of the upper hull supporting structure as accessible above the waterline.

At the first annual survey after construction, for column-stabilized units non-destructive tests may be required for welded joints particularly prone to stress concentration and fatigue, as deemed necessary by the Society on the basis of results of the new building survey or admission to class survey. The extent of the above mentioned examinations, when required, is to be agreed to by the Society and the Owner or operator prior to commencement of the Survey.

3 Annual survey - Machinery items

3.1

3.1.1 In addition to the requirements in Ch 3, Sec 3, [4], the survey is also to include:

- a) examination of jacking system of self elevating units
- b) inspection and test of fixed fire-extinguishing systems and other fire-extinguishing means provided for helicopter facilities
- c) examination of electrical installations of ventilation systems and machinery in dangerous spaces, with particular regard to those located in mud pump rooms and tanks and around vibrating screen
- d) testing and measurement of insulation resistance of electrical installations located in the above-mentioned spaces
- e) examination and test of fixed gas detecting and alarm system and of portable gas detectors.

3.2 Fire protection, detection and extinction

3.2.1 (1/7/2015)

The survey of fire prevention includes the examination, as far as practicable, and testing, as feasible and at random, of the fire and/or smoke detection systems.

4 Class renewal survey - Hull items

4.1 Planned survey program

4.1.1 The class renewal survey is to be carried out in accordance with the planned survey program indicated in Ch 2, Sec 2, [2.12].

4.1.2 In addition, the planned survey program is to include proposals on how to conduct surveys and tests in a safe and practical way, including the means of providing access to structures for survey, thickness measurements and testing. All other provisions described in Ch 2, Sec 2, [2.3], Ch 2, Sec 2, [2.5] to Ch 2, Sec 2, [2.9] regarding procedures for thickness measurements, conditions for survey, access to structures, equipment for survey are also to be complied with.

4.1.3 Prior to commencement of any part of the renewal survey, a survey planning meeting is to be held between the attending Surveyor(s), the Owner's representative in attendance, the thickness measurement company operator (as applicable) for the purpose of ascertaining that all the arrangements envisaged in the survey program are in place, so as to ensure the safe and efficient conduct of the survey work to be carried out.

4.2 Scope of survey

4.2.1 The class renewal survey is to include examination, tests and checks of sufficient extent to ensure that the hull and related piping are in satisfactory condition and fit for their intended purpose for the new period of class to be

assigned, subject to proper maintenance and operation and to periodical surveys being carried out at the due dates.

4.2.2 The class renewal survey is to include a bottom survey as laid down in Ch 3, Sec 6.

4.2.3 Watertight integrity of tanks, bulkheads, hull, decks and other compartments is to be verified by visual inspection.

4.2.4 The survey extent of ballast tanks converted to void spaces will be specially considered by the Society in relation to the requirements for ballast tanks.

4.2.5 (1/1/2016)

On all units careful examination is to be made of those parts of the structure particularly liable to excessive corrosion, or to deterioration or damage from causes such as chafing or handling of drilling equipment, stores, etc., and due to water collection in corners of bulkheads and on weather decks, and in other exposed areas.

Thickness measurements are to be carried out where wastage is evident or suspect.

4.2.6 All decks including helidecks and their supporting structure, deckhouses, casings and superstructures are to be examined. Where aluminium alloy is used in the structure bi-metallic joints are to be examined as far as practicable. Lifeboat and winch platforms and their supporting structures are to be examined.

4.3 Overall and close-up surveys

4.3.1 (1/1/2016)

Each class renewal survey is to include an overall survey of all tanks/holds and all spaces within hull/structure and superstructure.

The following parts are to be examined:

- The hull or platform structure including tanks, watertight bulkheads and deck, cofferdams, void spaces, sponsons, chain lockers, duct keels, helicopter deck and its supporting structure, machinery spaces, peak spaces, steering gear spaces, and all other internal spaces are to be examined externally and internally for damage, fractures, or excessive diminution. Thickness gauging of plating and framing may be required where wastage is evident or suspected.
- All tanks, compartments and free-flooding spaces throughout the drilling unit are to be examined externally and internally.
- Internal examinations of spud cans and mats may be specially considered.

4.3.2 (1/1/2016)

At the first and at subsequent class renewal surveys, representative tanks are to be examined by a close-up survey. The extent of the survey is to be agreed with the Society in advance of the survey. Suspect areas and critical structural areas should be examined and may be required to be tested for tightness, non-destructive tested or thickness gauged.

4.3.3 The Surveyor may extend the close-up survey as deemed necessary, taking into account the maintenance of

the tanks under survey, the condition of the corrosion prevention system and also in the following cases:

- a) where tanks have structural arrangements or details which have suffered defects in similar spaces or on similar units according to available information
- b) where tanks have structures approved with reduced scantlings due to an approved corrosion control system.

4.3.4 (1/1/2016)

All special and primary application structures (as defined in IACS Recommendation No. 11) and identified critical structural areas are to be subjected to Close up survey.

435 In addition to the requirements from [4.3.1] to [4.3.4], column-stabilized units are to have a complete bracing Close-up Survey consisting of a detailed dry examination of all bracings and their structural connections to columns and decks. The connections of columns to lower hulls, pontoons and upper hulls are to be examined. All critical regions indicated in [2.1.5] are to be examined by approved methods of NDE, refer also to Ch 2, Sec 2, [2.2.11]. Primary structure of the upper hull or platform which form 'Box' or 'I' type supporting structure and their end connections are to be examined. All free flooding areas and sponsons are to be examined.

436 In addition to the requirements from [4.3.1] to [4.3.4], self-elevating units are to have a complete survey of all legs, footings and mats. Particular attention is to be given to the leg structure in way of the waterline. Tubular or similar type legs are to be examined externally and internally including stiffeners and pin holes. All critical regions indicated in [2.1.4] are to be examined by approved methods of NDE including the leg connections to footings or mats, refer also to Ch 2, Sec 2, [2.12.1]. Jetting piping systems or other external piping particularly where penetrating footings or mats are to be examined.

437 Primary bulkheads in the upper hull of column-stabilized units and in the hull of self-elevating units are to be examined. Particular attention is to be given to the structure below and derrick sub-structures and supports under process plant, drilling derricks and other heavy equipment. Bulkheads adjacent to leg wells, turrets and moonpools are to be examined. Bulkhead penetrations in way of doors and other openings are to be examined.

438 For areas in tanks where protective coatings are found to be in good condition, as defined in Ch 2, Sec 2, [2.12.1], the extent of close-up survey may be specially considered.

4.4 Thickness measurements

4.4.1 (1/1/2016)

The minimum requirements for thickness measurements at class renewal survey are given in Tables 1, 2 and 3 which replace the requirements of Ch 3, Sec 5, Tab 2, as applicable.

4.4.2 (1/1/2016)

Provisions for extended measurements for areas with substantial corrosion are given in Table 4 which replace the requirements of Ch 3, Sec 5, Tab 3.

These extended thickness measurements are to be carried out before the survey is credited as completed. Suspect areas identified at previous class renewal and intermediate surveys are to be examined. Areas of substantial corrosion identified at previous class renewal and intermediate surveys are to be subjected to thickness measurements.

4.4.3 The surveyor may further extend the thickness measurements as deemed necessary.

4.4.4 For areas in tanks where protective coatings are found to be in good condition as defined in Ch 2, Sec 2, [2.12.1], the extent of thickness measurements according to Ch 3, Sec 5, Tab 2 may be specially considered.

4.4.5 Transverse sections are to be chosen where the largest reductions are suspected to occur or are revealed from deck plating measurements.

4.4.6 In cases where two or three sections are to be measured, at least one is to include a ballast tank within 0,5L amidships.

4.5 Tank testing

4.5.1 Double bottom, deep, ballast, peak and other tanks, including cargo holds assigned also for the carriage of salt water ballast, are to be tested with a head of liquid to the top of air pipes or to the top of hatches for ballast/cargo holds.

4.5.2 Boundaries of oil fuel, lubricating oil and fresh water tanks are to be tested with a head of liquid to the maximum filling level of the tank. Tank testing of oil fuel, lubricating oil and fresh water tanks may be specially considered based upon a satisfactory external examination of the tank boundaries, and a confirmation from the Master stating that the pressure testing has been carried out according to the requirements with satisfactory results.

4.5.3 The Surveyor may extend the tank testing as deemed necessary.

5 Class renewal survey - Machinery items

5.1 Pumps and valves

5.1.1 (1/1/2016)

Ballast and stripping pumps are to be internally examined and prime movers checked. A working test is to be carried out, as far as practicable.

Piping systems used solely for drilling operations are to be examined, as far as practical, operationally or hydrostatically tested to working pressure, to the satisfaction of the Surveyor.

Maintenance records of cargo pumps are to be made available to the surveyor.

5.1.2 An operating test of the remote control of pumps and valves and of automatic closing valves is to be carried out.

5.1.3 (1/1/2016)

Non-metallic flexible expansion pieces in the main salt water circulating system are to be examined internally and externally.

5.1.4 (1/1/2016)

Machinery systems intended for sustain the propulsion of units to which one of the additional service feature:

- assisted propulsion, or
- propulsion assist

is assigned, shall be submitted to the examinations required for self-propelled ships. Reference is to be made to the rule requirements given in Ch3, Sec 5, [3] of the Rules for Classification of Ships.

5.1.5 (1/1/2016)

On self-elevating type Mobile Offshore Drilling Units, the elevating systems are to be examined: pinions and gears of the climbing pinion gear train of rack and pinion systems are to be examined, as far as practicable, to the Surveyor's satisfaction by an effective crack detection method.

5.2 Electrical installations and ventilation systems

521 Electrical installations, ventilation systems and machinery in dangerous spaces re to be examined, with particular regard to those located in mud pump rooms and tanks and around vibration screens, in order to verify that no modification or alteration which would affect the safety has been made to the various installations without specific approval by the Society. Where required, disassembly is to be carried out by Manufacturer's technicians or specialized workshops.

5.2.2 (1/1/2016)

Electrical installations and ventilation system of enclosed hazardous areas such as those containing open active mud tanks, shale shakers, degassers and de-sanders are to be examined. In particular electric lighting, electrical fixtures, and instrumentation are to be examined, proven satisfactory and verified as explosion-proof or intrinsically safe.

Ventilating systems including ductwork, fans, intake and exhaust locations for enclosed restricted areas are to be examined, tested and proven satisfactory.

Ventilating air alarm systems to be proven satisfactory.

Electrical motors are to be examined including closed-loop ventilating systems for large D-C motors. Automatic power disconnect to motors in case of loss of ventilating air is to be proved satisfactory.

5.2.3 (1/1/2016)

Remote Shutdown Arrangements - Remote shutdown for fuel-oil transfer service pumps and ventilating equipment, together with oil tank outlet valves where required to be capable of being remotely closed are to be proved satisfac-

tory. Emergency switch(s) for all electrical equipment including main and emergency generators, except alarm and communication systems and lighting in vital areas such as escape routes and landing platforms, are to be proved satisfactory.

6 Bottom survey - Additional requirements for MODU

6.1 Docking survey

611 The survey is to be carried out with the unit in dry dock and is to include as far as applicable the operation specified in Ch 3, Sec 6. In addition, in general, the following is to be carried out, as applicable:

- a) examination of columns, legs, spud cans and mats, connections and structural nodes of the underwater structure
- b) non-destructive examinations of typical welded joints and, particularly, of critical joint subject to stress concentration and fatigue located in the underwater structure
- c) for self-elevating units, examination of internal structures of spud cans and mats
- d) for column stabilised units, external surfaces of the upper hull or platform, footings, pontoons or lower hulls, underwater areas of columns, bracing and their connections, sea chests, and propulsion units as applicable, are to be selectively cleaned and examined to the satisfaction of the attending surveyor. Non-destructive testing may be required of areas considered to be critical or found to be suspect by the surveyor.

In the case of units which, due to their dimensions or to other reasons, cannot be dry docked, alternative means of underwater survey deemed adequate by the Society may be considered; in any case, conditions equivalent to those of the docking survey are to be applied.

6.2 Underwater survey

621 Upon application of the owner, the Society may authorize a survey of the underwater structure in the floating condition in lieu of the docking survey.

The validity of the underwater inspection is subjected to the conditions specified in Ch 3, Sec 6, [3] and, in addition, the thickness of external plating of the areas in way of compartments, which cannot be examined internally, is measured.

7 Survey of propulsion systems

7.1 Periodical survey of other propulsion systems

7.1.1 Rotating and azimuth thrusters

The periodical survey of rotating and azimuth thrusters consists of:

a) removing the propeller(s) in order to examine the following items, as applicable:

- 1) exposed parts
- 2) cone and keyway to be checked by an appropriate crack detection method
- 3) sealing glands
- 4) threaded end and nut.

For keyless or flange mounted propellers, alternative means to removal of the propeller for examination of

the shaft cone, such as pressure testing of the hub and hub gland, may be adopted at alternate surveys;

- b) examining the results of a lubricating oil analysis (water content and presence of material particles) to detect possible deterioration of internal gears and bearings
- c) examining the orientation device.

If the foregoing checks are not satisfactory, dismantling of the internal parts may be required.

7.12 Vertical axis propellers

The periodical survey of vertical axis propeller systems consists of:

Table 1 : Minimum Requirements for Thickness Measurements for Surface-Type Units at Special Survey (1/1/2016)

Special Survey No.1 Age \leq 5	Special Survey No.2 < 5 Age \leq 5	Special Survey No.3 10 < Age \leq 15	Special Survey No.4 and subsequent 15 > Age
Suspect areas throughout the unit	Suspect areas throughout the unit	Suspect areas throughout the unit	Suspect areas throughout the unit
	One transverse section of deck plating abreast the moon pool opening within the amidships 0.6L, together with internals in way as deemed necessary. Where unit is configured with side ballast tanks, the plating and internals of the tanks are also to be gauged in way of the section chosen.	Two Transverse Sections (Girth Belts) of deck, bottom and side plating abreast the moon pool and one hatch opening within the amidships 0.6L together with internals in way as deemed necessary. Where unit is configured with side ballast tanks, the plating and internals of the tanks to be gauged in way of the required belts, Remaining internals in ballast tanks to be gauged as deemed necessary.	A minimum of three Transverse Sections (Girth Belts) of deck, bottom, side, and longitudinal-bulkhead plating in way of the moon pool and other areas within the amidships 0.6L, together with internals in way (including in perimeter ballast tanks, where fitted in way of belts).
	Moon pool boundary bulkhead plating.	Moon pool boundary bulkhead plating.	Moon pool boundary bulkhead plating.
		Internals in forepeak tank and aft peak tank as deemed necessary.	Internals in forepeak and after peak tanks as deemed necessary.
			Lowest strake of all transverse bulkheads in hold spaces. Remaining bulkhead plating to be gauged as deemed necessary.
			All plates in two wind and water strakes, port and starboard, full length.
<p>(1) Thickness measurement locations are to be selected to provide the best representative sampling of areas likely to be most exposed to corrosion, considering ballast history and arrangement and condition of protective coatings..</p> <p>(2) Thickness measurements of internals may be specially considered by the Surveyor if the hard protective coating is in GOOD condition.</p> <p>(3) For units less than 100 meters in length, the number of transverse sections required at Special Survey No. 3 may be reduced to one (1), and the number of transverse sections required at subsequent Special Surveys may be reduced to two (2).</p> <p>(4) For units more than 100 meters in length, at Special Survey No. 3, thickness measurements of exposed deck plating within amidship 0.5 L may be required.</p>			

Special Survey No.1 Age ≤ 5	Special Survey No.2 < 5 Age ≤ 5	Special Survey No.3 10 < Age ≤ 15	Special Survey No.4 and subsequent 15 > Age
			All exposed main deck plating full length and all exposed first-tier super-structure deck plating (poop, bridge and forecastle decks).
			All keel plates full length plus additional bottom plating as deemed necessary by the Surveyor, particularly in way of cofferdams and machinery spaces.
			Duct keel or pipe tunnel plating or pipe tunnel plating and internals as deemed necessary.
			Plating of sea chests. Shell plating in way of overboard discharges as considered necessary by the attending surveyor.
<p>(1) Thickness measurement locations are to be selected to provide the best representative sampling of areas likely to be most exposed to corrosion, considering ballast history and arrangement and condition of protective coatings.</p> <p>(2) Thickness measurements of internals may be specially considered by the Surveyor if the hard protective coating is in GOOD condition.</p> <p>(3) For units less than 100 meters in length, the number of transverse sections required at Special Survey No. 3 may be reduced to one (1), and the number of transverse sections required at subsequent Special Surveys may be reduced to two (2).</p> <p>(4) For units more than 100 meters in length, at Special Survey No. 3, thickness measurements of exposed deck plating within amidship 0.5 L may be required.</p>			

Table 2 : Minimum Requirements for Thickness Measurements for Self-Elevating Units at Special Survey (1/1/2016)

Special Survey No.1 Age ≤ 5	Special Survey No.2 < 5 Age ≤ 10	Special Survey No.3 10 < Age ≤ 15	Special Survey No.4 and subsequent 15 > Age
Suspect areas throughout the unit (particular attention to be paid to the legs in way of the Splash Zone).	Suspect areas throughout the unit.	Suspect areas throughout the unit.	Suspect areas throughout the unit.
	Legs in way of Splash Zone.	Legs in way of Splash Zone.	Legs in way of Splash Zone.
	Primary application structures where wastage is evident.	Representative gaugings, through- out, of special and primary application structures.	Comprehensive gaugings, through- out, of special and primary application structures.
	Representative gaugings of upper hull deck and bottom plating and internals of one preload (ballast) tank.	Leg well structure.	Leg well structure.
		Representative gaugings of deck, bottom, and side shell plating of hull and mat.	Representative gaugings of deck, bottom, and side shell plating of hull and mat.
<p>(1) Structural application designation (Special, Primary, Secondary) are defined in IACS Recommendation No. 11.</p>			

Special Survey No.1 Age \leq 5	Special Survey No.2 < 5 Age \leq 10	Special Survey No.3 10 < Age \leq 15	Special Survey No.4 and subsequent 15 > Age
		Representative gaugings of upper hull deck and bottom plating and internals of at least two preload (ballast) tanks.	Substructure of derrick as deemed necessary.
			Representative gaugings of internals of all preload (ballast) tanks.
(1) Structural application designation (Special, Primary, Secondary) are defined in IACS Recommendation No. 11.			

Table 3 : Minimum Requirements for Thickness Measurements for Column-Stabilized Units at Special Survey (1/1/2016)

Special Survey No.1 Age \leq 5	Special Survey No.2 < 5 Age \leq 5	Special Survey No.3 10 < Age \leq 15	Special Survey No.4 and subsequent 15 > Age
Suspect areas throughout the unit.	Suspect areas throughout the unit.	Suspect areas throughout the unit.	Suspect areas throughout the unit.
Columns and bracings where wastage is evident in Splash Zone.	Representative gaugings of columns and bracings in Splash Zone together with internals in way as deemed necessary	.Representative gaugings, throughout, of special and primary application structures.	Comprehensive gaugings, throughout, of special and primary application structures
	Special and primary application structure where wastage is evident	One Transverse Section (Girth Belt) of each of 2 columns and 2 bracings in Splash Zone together with internals in way as deemed necessary	One Transverse Section (Girth Belt) of each of one-half of the columns and bracings in Splash Zone and internals in way as deemed necessary (i.e., gauge half of the unit's columns and bracings in Splash Zone).
		Lower hulls in way of mooring lines where wastage is evident.	Lower hulls in way of mooring lines where wastage is evident.
		One Transverse Section (Girth Belt) of each lower hull between one set of columns.	One Transverse Section (Girth Belt) of each lower hull between one set of columns.
			Representative gaugings of substructure of drilling derrick
(1) Structural application designation (Special, Primary, Secondary) are defined in IACS Recommendation No. 11.			

Table 4 : Guidance for Additional Thickness Measurements in way of Substantial Corrosion (1/1/2016)

STRUCTURAL MEMBER	EXTENT OF MEASUREMENT	PATTERN OF MEASUREMENT
Plating	Suspect area and adjacent plates	5 point pattern over 1 square meter
Stiffeners	Suspect area	3 measurements each in line across web and flange

SECTION 6

FLNG

1 General

1.1 Application

1.1.1 (1/7/2011)

The requirements of this Section apply to all units which have been assigned the service notation **FLNG**.

2 All surveys - Hull and cargo installation items

2.1 General

2.1.1 (1/7/2011)

The requirements in Sec 5 for units which have been assigned the service notation **FSRU** are applicable also to the corresponding or similar items of **FLNG** units.

2.2 Liquefaction plants

2.2.1 (1/7/2011)

In general, the machinery and equipment of the liquefaction process, including handling of condensates and process liberated vapours and all refrigerants involved, are to be surveyed to the same extent as required for similar equipment on board **FPSO** units at the class renewal survey (refer to Sec 3).

2.2.2 (1/7/2011)

Consideration is also to be given to the survey requirements of the industrial standards applicable to the liquefaction process, listed in Pt E, Ch 5, Sec 17.

SECTION 7

SPECIAL SERVICE

1 General

1.1

1.1.1 (1/7/2015)

When the service notation special service, as per Ch 1, Sec 2, [4.9.1], is assigned, whether no additional survey

requirements are indicated in the annex to the Certificate of Classification, the Annual Survey and the Renewal Survey are, in any case, to include the examination, to the extent deemed necessary by the Surveyor, of the equipment and arrangements on the basis of which the service notation has been assigned.

SCOPE OF SURVEYS RELATED TO ADDITIONAL CLASS NOTATIONS

SECTION 1	GENERAL
SECTION 2	AUTOMATED MACHINERY SYSTEMS
SECTION 3	MONITORING EQUIPMENT
SECTION 4	POLLUTION PREVENTION (GREEN PLUS)
SECTION 5	HELIDECK
SECTION 6	DRILLING SYSTEMS
SECTION 7	OTHER NOTATIONS

SECTION 1

GENERAL

1 General

1.1

221 The purpose of this Chapter is to give details on the scope of surveys of specific equipment and systems fitted on board the unit, which are covered by an additional class notation. Unless otherwise specified in Ch 1, Sec 2, [6], the scope of these surveys provides the requirements to be complied with for the maintenance of the relevant additional class notation.

222 These specific requirements are additional to those laid down in Chapter 3 and Chapter 4. These surveys are to be carried out at intervals as described in Ch 2, Sec 2, as far as possible concurrently with the surveys of the same type, i.e. annual, intermediate or class renewal survey.

223 The equipment and systems are also to be submitted to occasional survey whenever one of the cases indicated in Ch 2, Sec 2, [6] occurs.

224 Where specific requirements are given in this Chapter for the class renewal survey, they are additional to the applicable requirements for the annual survey.

225 For the assignment of the additional class notations, units are to be submitted to an admission to class survey as described in Ch 2, Sec 1, [2] and Ch 2, Sec 1, [3] for new and existing installations, respectively, as applicable.

2 Additional class notations subject to additional surveys

2.1

211 The specific requirements detailed in this Chapter are linked to the additional class notation(s) assigned to the unit. Where a unit has more than one additional class notation, the specific requirements linked to each additional class notation are applicable as long as they are not contradictory.

212 Tab 1 indicates which additional class notations are subject to specific requirements, and in which Section and/or Article they are specified.

Table 1 : Additional class notations for which specific survey requirements are applicable (1/7/2013)

Additional class notation	Section or Article applicable in this Chapter	Type of surveys affected by these specific requirements	Remarks
Automated machinery systems: AUT-UMS AUT-CCS	Sec 2	annual survey class renewal survey	
Drilling systems: DRILLING	Sec 6	annual survey class renewal survey	
Monitoring equipment: MON-HULL	Sec 3	annual survey class renewal survey	
Pollution prevention GREEN PLUS	Sec 4	annual survey class renewal survey	
HELIDECK-H HELIDECK	Sec 5	annual survey class renewal survey	
Navigation in ice environment ICE CLASS IA SUPER ICE CLASS IA ICE CLASS IB ICE CLASS IC ICE CLASS ID ICE POLAR CLASS	See Remarks	See Remarks	Refer to Pt A, Ch 5, Sec 9 of the Rules for Classification of Ships

Additional class notation	Section or Article applicable in this Chapter	Type of surveys affected by these specific requirements	Remarks
PMS	See Remarks	See Remarks	The scope and periodicity of surveys are stipulated by specific requirements given in Part F, Chapter 1
WINTERIZATION	See Remarks	See Remarks	Refer to Pt A, Ch 5, Sec 9 of Rules for Classification of Ships
Other notations DYNAPOS VCS CARGOCONTROL COAT-WBT DIVINGSUPPORT HVSC TAS	Sec 7	As applicable in accordance with the related Articles in Sec 7	

SECTION 2

AUTOMATED MACHINERY SYSTEMS

1 General

1.1

1.1.1 The requirements of this Section apply to units which have been assigned one of the following additional class notations related to automated machinery systems, as described in Ch 1, Sec 2, [6.2.2] and Ch 1, Sec 2, [6.2.3]:

AUT-UMS

AUT-CCS

2 Annual survey

2.1

211 The Owner or his representative is to declare to the attending Surveyor that no significant modifications have been made without prior approval by the Society.

212 The annual survey is to include:

- a general examination of the control systems covered by the notation, including a random check of the proper operation and calibration of main measuring, monitoring, alarm, and automatic shut-off devices;
- a check of the fire detectors;
- a check of the bilge flooding alarms;
- a running test which may be also performed by a spot check method.

3 Class renewal survey

3.1

3.1.1 The requirements given in Sec 4, [2] for annual survey are to be complied with. An additional program of examinations, checks and tests is to be devised in agreement with the Owner and based on the operational data and experience of previous surveys. This program is to include verification of the calibration of instruments and testing of control and safety functions of the machinery. The Owner is to produce evidence that all these checks and tests have been carried out and this will be verified by the Surveyor at random. In addition, the proper operation of the control system of propulsion machinery is to be checked during sea trials or functional tests, as applicable.

SECTION 3

MONITORING EQUIPMENT

1 General

1.1 Application

1.1.1 The requirements of this Section apply to units which have been assigned one of the following additional class notations related to hull and tailshaft monitoring equipment, as described in Ch 1, Sec 2, [6.3.2]:

MON-HULL

2 MON-HULL

2.1 Annual and class renewal survey

2.1.1 The Owner or his representative is to declare to the attending Surveyor that the hull monitoring equipment has been recently calibrated using a reference loading case.

SECTION 4

POLLUTION PREVENTION (GREEN PLUS)

1 General

1.1 Application

1.1.1 The requirements of this Section apply to units which have been assigned the additional class **GREEN PLUS** notations related to pollution prevention systems, as described in Ch 1, Sec 2, [6.5].

1.1.2

a) Certificates and documents

- 1) confirmation that the IOPP certificate is valid
- 2) confirmation that the "International Pollution Prevention Certificate for the Carriage of Noxious Liquid Substances in Bulk" or the "International Certificate of Fitness for the Carriage of Dangerous Chemicals in Bulk" (ICOF CHE Certificate), as applicable, is valid
- 3) confirmation that the "International Sewage Pollution Prevention Certificate" (ISPP Certificate) is valid
- 4) confirmation that the "International Anti Fouling System Certificate" (AFS Certificate) or statement of compliance is valid
- 5) confirmation that an approved SOPE Plan is available on board
- 6) verification of the proper updating of the sewage record book
- 7) confirmation that an approved Ballast Water Management Plan is available on board and verification of the proper updating of the ballast water record book
- 8) confirmation that an approved Garbage Management Plan is available on board and verification of the proper updating of the garbage record book
- 9) confirmation that the Ship Environmental Management Plan is available onboard.
- 10) verification that an officer, defined as Ship Environmental Manager, is in service on board.
- 11) confirmation that the special list or manifest or a detailed stowage plan related to the harmful substances carried is available on board

b) for oily wastes

- 1) check of the compliance of the bilge system with the approved drawings (no bypasses for overboard discharge)
- 2) verification that a periodical calibration of the bilge water filtering equipment has been carried out at

least every 6 months and that documents reporting the last calibration are available on board

- 3) verification that the Oil Systems log-book is duly filled in (at least every week)
- 4) verification that the overflow system and high level alarm, or overflow system and flow alarm in the overflow main, or two high level alarms (90% and 95%), installed on fuel oil and lubricating oil tanks with volume >10m³ are well maintained and in good working condition
- 5) verification that each fixed container or enclosed deck area provided with fuel or lubricating oil tank vents, overflows and fill pipe connection on the weather and/or superstructure decks is well maintained and in good working condition

c) for sewage

- 1) confirmation of the proper operation of the sewage treatment plant
- 2) verification of the satisfactory condition of the standard sewage discharge connection
- 3) verification that high level alarms for sewage holding tanks are well maintained and in good working condition

d) for garbage

- 1) verification of the effective application of the Ship Environmental Management Plan
- 2) verification of proper location of placards for garbage discharge
- 3) confirmation of the proper operation of the garbage treatment plant fitted onboard
- 4) verification that the garbage record book is properly filled in

e) for harmful aquatic organisms in ballast water

- 1) examination of the ballast water treatment system, where fitted, based on the Manufacturer's maintenance instructions

f) for harmful substances carried in packaged form

- 1) verification, to the Surveyor's satisfaction, that the harmful substances are properly stowed as specified in the above documentation

g) for ship recycling

- 1) verification that the Green Passport is available on board and verification, to the Surveyor's satisfaction, of proper updating, where the unit has undergone modification work affecting the Green Passport.

h) Certificates and documents

- 1) confirmation that the Ship Environmental Management Plan is available onboard.
- 2) confirmation that the "Engine International Air Pollution Prevention Certificates " (EIAPP Certificate or Document of Compliance) are available on board as applicable
- 3) confirmation that the engine technical file and record book are available on board and properly updated
- 4) verification that the **VCS** notation is still granted to the unit (this item applies to FSO and FPSO units
- 5) verification of the records kept on board of the purchase orders and sulphur content check of the fuel and of the management of fuels when fuels with different sulphur contents are used
- 6) confirmation that the Manufacturer's operating manuals for incinerators are available on board

i) for emissions of ozone depleting substances

- 1) verification of the availability of the operating manual detailing the procedures to be followed to minimise the risk of releasing ozone depleting substances in all the operative and emergency conditions
- 2) verification of the annual consumption figures of refrigerants and of corrective actions undertaken if the 10% limit has been exceeded

j) for emissions of nitrogen oxides (NO_x)

- 1) verification of the proper operation of the devices to control NO_x emissions
- 2) verification that engine parameters are as specified in the engine technical file
- 3) verification of replacements of engine components with those specified in the engine technical file

k) for emissions of sulphur exhaust (SO_x)

- 1) examination of the exhaust gas cleaning system, where fitted, based on the Manufacturer's maintenance instructions

l) for emissions from incinerators

- 1) examination of the incinerators in working conditions, including monitoring and control devices.

The survey is, as far as practicable, to include the following checks:

- m) verification that the marine growth prevention systems are well maintained and in good working condition;
- n) verification that all the additional systems and components involved in the unit's environmental index calculation (see Pt F, Ch 4, Sec 1, Tab 2 and Pt F, Ch 4, Sec 1, [7], if any) are well maintained and in good working condition;
- o) verification that all the additional procedural means involved in the unit's environmental index calculation (see Pt F, Ch 4, Sec 1, Tab 2 and Pt F, Ch 4, Sec 1, [7], if any) are followed and documented by appropriate recording;
- p) verification that adequate training on environmental issues is planned, carried out and documented for all the persons on board having influence on the environmental behaviour of the unit.

SECTION 5

HELIDECK

1 General

1.1 Application

1.1.1 The requirements of this Section apply to units which have been assigned one of the following additional class notations related to helicopter facilities, as described in Ch 1, Sec 2, [6.10.12]:

HELIDECK

HELIDECK-H

2 Annual survey

2.1

2.1.1 The Owner or his representative is to declare to the attending Surveyor that no significant modifications to structure, systems and fire protection have been made without prior approval by the Society.

2.1.2 The annual survey is to include:

- a) Examination of the supporting structures of the helicopter deck, including the connections to the deck of the unit.
 - b) Examination of the details of the arrangements in way of the bimetallic connections, where aluminium alloy plat-forms are connected to steel structures.
 - c) Check that the overall coating of non-slip material or other arrangements, provided to minimize the risk of personnel or helicopters sliding off the landing area are in satisfactory condition.
 - d) Check that the drainage system, if fitted, provided in association with a perimeter guttering system or slightly raised curb to prevent spilled fuel falling on to other parts of the unit and led to a safe area, is in satisfactory condition.
 - e) Confirmation that a sufficient number of tie-down points are provided to secure the helicopter.
 - f) Confirmation that a wind pennant or flag is fitted and properly illuminated.
 - g) Verification that the peripheral safety net system, if any, is in satisfactory condition.
 - h) When refuelling facilities are fitted:
 - 1) Confirmation that fuel storage area is provided with arrangements whereby fuel spillage may be collected and drained to a safe location.
 - 2) Confirmation that "NO SMOKING" signs are displayed at appropriate locations.
 - 3) Confirmation that tanks and associated equipment are to be protected against physical damage and from a fire in an adjacent space or area.
- 4) Confirmation that remote shutdown of storage tank fuel pumps (or equivalent closing arrangements for gravity tanks) are in working condition.
 - 5) Verification that the fuel pumping unit is connected to one tank at a time and the piping between the tank and the pumping unit is of steel or equivalent material, as short as possible, and protected against damage.
 - 6) Verification that electrical equipment in the refuelling systems, refuelling area, hangars containing refuelling systems are in satisfactory condition and have been properly maintained.
- i) For fire-fighting appliances and rescue equipment, verification that the following are stored in close proximity to the helideck and are ready for efficient use:
 - 1) at least two dry powder extinguishers having a total capacity of not less than 45 kg;
 - 2) carbon dioxide extinguishers of a total capacity of not less than 18 kg or equivalent;
 - 3) a suitable foam application system consisting of monitors or foam making branch pipes capable of delivering foam to all parts of the helideck;
 - 4) the principal agent suitable for use with salt water and conform to performance standards not inferior to those acceptable to the Society;
 - 5) at least two nozzles of an approved dual-purpose type (jet/spray) and hoses sufficient to reach any part of the helideck;
 - 6) at least the following equipment:
 - adjustable wrench;
 - blanket, fire resistant;
 - cutters, bolt 60 cm;
 - hook, grab or salving;
 - hacksaw, heavy duty complete with 6 spare blades;
 - ladder;
 - lift line 5 mm diameter x 15 m in length;
 - pliers, side cutting;
 - set of assorted screwdrivers; and
 - harness knife complete with sheath.
 - j) For hangars or spaces containing refuelling installations:
 - 1) Verification that hangars ventilation system is capable of at least 6 air changes per hour.
 - 2) Verification that the system is entirely separated from other ventilation systems.
 - 3) Verification that the system is such as to prevent air stratification and the development of air pockets.

- 4) Verification that means are provided to indicate on the navigating bridge any loss or reduction of the required ventilating capacity.
 - 5) Verification that arrangements are provided to permit a rapid shutdown and effective closure of the ventilation ducts and openings from outside of the served space in case of fire.
- k) For hangars, refuelling and maintenance facilities:
- 1) Verification of the operational readiness and maintenance of fixed fire-fighting systems.
 - 2) Examination, as far as possible, and test, as feasible, of fixed fire detection and alarm system.
 - 3) Examination of the provision and the condition of:
 - the portable foam applicator unit of capacity of 20 l with a spare charge;
 - the foam-type fire extinguishers, each of at least 45 l capacity or equivalent;

- a sufficient number of portable foam extinguishers or equivalent which are to be so located that no point in the space is more than 10 m walking distance from an extinguisher and that there are at least two such extinguishers in each such space.

- l) Confirmation that the means of escape from the helideck and associated spaces are satisfactory.

3 Class renewal survey

3.1

3.1.1 The requirements, given in [2] for annual survey, are to be complied with. An additional planned survey program, as indicated in Ch 2, Sec 2, [2.12], including examinations, checks and tests as applicable, is to be devised in agreement with the Owner and based on the operational data and experience of previous surveys.

SECTION 6

DRILLING SYSTEMS

1 General

1.1 Application

1.1.1 (1/1/2011)

The requirements of this Section apply to units which have been assigned the additional class notation **DRILLING** related to drilling systems, as described in Ch 1, Sec 2, [6.10.13].

2 Annual survey

2.1

2.1.1 (1/1/2011)

The survey is to include:

- a) examination of exposed surfaces of the derrick, derrick support structure, burner booms, stabbing boards, racking platforms and drilling equipment foundations. The inspection of the derrick and related structural members are to include:
 - 1) the general condition of the structure, especially bent, missing or abraded parts and lost corrosion protection coatings
 - 2) tightness of bolts
 - 3) condition of wire ropes and fittings
 - 4) functional testing of gear
 - 5) condition of welded joints
 - 6) thickness measurements as required
- b) general external examination, so far as accessible, of the following items:
 - 1) blow-out preventer (BOP) stack and control systems
 - 2) driller's console and drilling motors
 - 3) diverter
 - 4) choke / kill manifold
 - 5) derrick, derrick support structure and well test / burner booms
 - 6) draw works, rotary table and rotating equipment
 - 7) bulk storage and transfer systems
 - 8) pipe handling and overhead drilling equipment
 - 9) compressors for drilling related functions
 - 10) internal combustion engines driving drilling machinery
 - 11) hose-connecting riser and choke / kill systems
 - 12) high pressure piping, including mud and cement systems

- 13) fire detection, gas detection and fire protection systems
 - 14) emergency shutdown system
 - 15) lifting equipment and devices
 - 16) electrical and instrumentation equipment
 - 17) well testing equipment
 - 18) motion compensation equipment
 - 19) marine risers, tensioning system, ball joint connections and telescopic joints for damage, excess corrosion, fracturing or malfunction
- c) verification that protective covers, insulation, shrouds and protective guards around moving parts are in position and in working order
 - d) examination of derrick walkways and ladders, drill floor and drill system machinery spaces with particular attention to fire and explosion hazards
 - e) verification that emergency escape routes are not blocked
 - f) external examination of piping systems, flexible hoses, insulation and gauges
 - g) examination of safety shutdown devices
 - h) verification of calibration of the gas detectors
 - i) general examination of all electrical and instrumentation systems, including protective devices and cable supports
 - j) examination of mud and cement systems for potential hazards
 - k) examination of BOP test log.

2.1.2 (1/1/2011)

Pressure vessels are to be examined only at the first annual survey after commissioning in accordance with the requirements for class renewal surveys given in [7.1.2] and [7.1.3]. Thereafter, they are to be examined at subsequent class renewal surveys.

2.1.3 (1/1/2011)

Where due to operational requirements it is not possible to present all pressure vessels for inspection at the first annual survey, a sufficient number of pressure vessels from each system are to be examined, as agreed with the Surveyor, in order to establish the extent of corrosion and general condition of the system. The Owner's proposals for the inspection of the remaining pressure vessels are to be included in the Owner's planned maintenance and inspection procedure as required in Ch 2, Sec 2, [2.11].

2.1.4 (1/1/2011)

Selected pressure safety valves are to be bench tested in accordance with the planned procedure for maintenance and inspection as required in Ch 2, Sec 2, [2.11].

3 Class renewal survey

3.1

3.1.1 (1/1/2011)

The survey is to include the following:

- a) inspection of the foundations connected to the structure relevant to main machinery and gearboxes
- b) testing of pressure piping systems as considered necessary by the surveyor
- c) pressure testing of drilling system, piping systems and flexible hoses to 1,25 times the maximum allowable working pressure
- d) examination of electrical installation and machinery within dangerous areas, with particular reference to those fitted inside production modules and mud pits and around shale-shakers
- e) testing of the electrical insulation resistance of the electrical equipment and circuits terminating in or passing through the dangerous zones. However, in cases where a proper record of testing is maintained, consideration may be given to accepting recent test readings effected by the unit's personnel
- f) examination and check of insulation resistance of motors which are part of the drilling system
- g) vibration checks of rotating drilling machinery

- h) pressure test to working pressure and complete performance test of the blow-out preventer
- i) examination of mud and cement pump fluid ends
- j) examination of the safety systems, including testing of hydrocarbon and hydrogen sulphide detection systems and operational test of emergency shutdown systems
- k) well testing equipment
- l) choke manifold and associated valves
- m) heave compensation equipment
- n) drilling derrick hoisting, rotation and pipe handling equipment.

3.1.2 (1/1/2011)

Pressure vessels forming part of the drilling system are to be examined internally and externally. Principal mountings, supports and attachments to pressure vessels are to be examined.

3.1.3 (1/1/2011)

Where pressure vessels are so constructed that internal inspection is prevented by normal means, agreed tests are to be carried out to the satisfaction of the Surveyor.

3.1.4 (1/1/2011)

Selected pressure safety valves are to be bench tested in accordance with a planned procedure for maintenance and inspection of the drilling system. The surveyor is to confirm that all pressure safety valves forming part of the drilling system are examined and bench tested within each class renewal survey cycle.

SECTION 7

OTHER NOTATIONS

1 General

1.1

1.1.1 (1/1/2023)

The requirements of this Section apply to units which have been assigned one of the following additional class notations described in Ch 1, Sec 2:

DYNAPOS

VCS

CARGOCONTROL

COAT-WBT

DIVINGSUPPORT

HVSC

TAS

ARS.

2 DYNAPOS

2.1 Annual survey

2.1.1 The program of the annual survey may be previously agreed with the Society.

The Owner or his representative is to declare to the attending Surveyor that no significant alterations have been made without the prior approval of the Society.

2.1.2 The annual survey is to include:

- an examination of the log-books to verify the proper operation of systems in the period subsequent to the last survey and measures taken to avoid repetition of any malfunctions or failures which have occurred during the same period
- general examination of visible parts of thrust units, including their prime movers
- general examination of the electrical power system and switchboards
- general examination of control, monitoring and alarm devices
- running test of the installation, including random test by simulation of different alarms and relevant backup systems and switching modes.

2.2 Class renewal survey

2.2.1 In general, the class renewal survey consists of the checks detailed in [2.2.3] to [2.2.6]. However, a specific program of the class renewal survey prepared by the Owner and taking into account the maintenance procedures of the

Manufacturers of the system is to be submitted to the Society prior to the survey.

2.2.2 The Owner is to confirm that any modification to the software is fully documented and properly recorded.

2.2.3 Prime movers of thrust units, electrical installations and electric power generators are to be surveyed and tested to the same extent as required in Ch 3, Sec 5, [3] for similar equipment for the class renewal survey of machinery.

2.2.4 During the bottom survey the thrust units are to be generally examined. Other checks are to be carried out, such as taking clearances, examination of the orientation device or variable pitch system, if any, verifying tightness devices, examination of results of lube oil analysis for detection of possible deterioration of internal gears and bearings. Dismantling of internal parts may be required if the above examinations are not satisfactory.

2.2.5 Sensors and position reference systems are to be tested to check their accuracy. Failure of sensors is to be simulated in order to check the related alarm system and switching logic. Switch over to the different reference systems is to be checked.

2.2.6 An operational test of the installation is to be performed, including:

- test of each thrust unit at different loads, pitches and speeds, and check of monitoring devices
- test of the thrust controls in the different available modes (automatic, semi-automatic, manual), and the switch over between the different modes
- test of the different alarms and safety systems, using simulated conditions as necessary
- test of power supply failure and verification of intended functioning in such cases
- final test to verify the capacity of the system to keep the unit in the intended position and maintain the heading, with related alarm and monitoring devices. The accuracy of the system is to be checked and compared with previous results for evaluation of drift
- test of the power management system.

3 VCS

3.1 Annual survey

3.1.1 The Owner or his representative is to declare to the attending Surveyor that no significant modifications have been made without the prior approval of the Society.

3.1.2 The annual survey is to include:

- an examination of the instruction manual to verify the layout of the complete system and confirm the correspondence to the actual system fitted on board
- a general examination of components of the system such as vapour piping (including manifold and hoses), cargo tank gauging equipment, cargo tank level alarms, vapour pressure alarms and vapour balancing, if any, to verify their satisfactory condition.

3.2 Class renewal survey

3.2.1 The requirements given in [3.1] for annual survey are to be complied with. Additionally, the following is to be carried out:

- a pressure test of the vapour piping, including manifold and hoses
- a check and test of the instrumentation (cargo tank gauging equipment, cargo tank level alarms, vapour pressure alarms)
- an inspection and test of the vapour balancing equipment, if any
- a running test of the system.

3.3 Class renewal survey

3.3.1 The requirements given in [7.1] for annual survey are to be complied with. Additionally, the following is to be carried out:

- an inspection of the components of the system to the same extent as required in Ch 3, Sec 5, [3] for similar equipment for the class renewal survey of machinery
- a running test of the system.

4 CARGOCONTROL

4.1 Annual survey

4.1.1 The Owner or his representative is to declare to the attending Surveyor that no significant modifications have been made without the prior approval of the Society.

4.1.2 The annual survey is to include:

- a general examination of the items of equipment regarding remote control of operations and gauging/alarms provided for all those parameters that are required to be kept under control to verify their satisfactory condition
- a running test which may be also performed by a spot check method.

4.2 Class renewal survey

4.2.1 The requirements given in [4.1] for annual survey are to be complied with. Additionally, the following is to be carried out:

- a check and test of the instrumentation fitted to the components of the system
- an overall running test of the system.

5 COAT-WBT

5.1 General

5.1.1 For the additional class notation **COAT-WBT** to be retained during the lifetime of the unit, the protective coatings are to be checked by the Society during the examination of the water ballast tanks at class surveys and their condition is to be assessed as GOOD, as per the definition given in Ch 2, Sec 2, [2.2.11].

The scope of the coating examination during intermediate and class renewal surveys is laid down in [5.2].

In addition, the Owner is to notify the Society of any damage to the protective coatings, as laid down in [5.3].

5.2 Intermediate and class renewal surveys

5.2.1 The protective coatings of all water ballast tanks subject to examination at intermediate and class renewal surveys are to be checked.

5.2.2 In addition, where any remarks or damage to the protective coatings have been recorded, the relevant areas inside water ballast tanks are also to be examined.

5.2.3 When the coating is found to be in less than GOOD condition, as defined in Ch 2, Sec 2, [2.2.11], the Owner is to carry out those repairs as required by the attending Surveyor to restore the coating condition to GOOD at the intermediate or class renewal surveys. Failure to carry out the above repairs will result in suspension of the additional class notation **COAT-WBT**.

5.3 Coating damage and repairs

5.3.1 The Owner is to keep records and inform the attending Surveyor at the first subsequent attendance on board about any damage to the protective coatings which has been found and left for further inspection or already repaired since the date of first classification or last intermediate or class renewal survey, as applicable. However, where the nature and/or extent of damage to the coating is significant, the Owner is to inform the Society for the attendance of a Surveyor before repairs are carried out.

5.3.2 Coating is to be repaired in accordance with the paint Manufacturer's recommendations.

The attending Surveyor is to check that damage to the coating has been properly repaired according to the technical specifications and that it has been restored to GOOD condition; this may be done during the intermediate or class renewal survey, or during an occasional survey, upon the Owner's request or subject to the decision of the Society.

6 DIVINGSUPPORT

6.1 Annual survey

6.1.1 The Owner or his representative is to declare to the attending Surveyor that no significant alterations have been made without the prior approval of the Society.

6.1.2 The annual survey is to include:

- a) a general examination of all components of the diving system arrangements and installation to verify their satisfactory condition
- b) an examination of the hull structures supporting and adjacent to the diving system arrangements and installation to verify that no deformations or fractures have developed
- c) a functional test of electrical systems and communication systems.

6.2 Class renewal survey

6.2.1 The class renewal survey is to include:

- a) a close-up examination of all components of the diving system arrangements and installation to verify their satisfactory condition
- b) a close-up examination of the hull structures supporting and adjacent to the diving system arrangements and installation to verify that no deformations or fractures have developed
- c) checking the unit's capability to maintain its position during diving operations
- d) a functional test of electrical systems and communication systems and measurement of insulation resistance.

Where deemed necessary by the Surveyor, non-destructive tests for measuring thickness deterioration or checking for fractures or other defects may be required.

7 HVSC

7.1 Annual and class renewal survey

7.1.1 The survey is, as far as practicable, to include the checks required in Ch 3, Sec 3, [4.3] and Ch 3, Sec 5, [3.6] and [3.7].

In addition a record of annual maintenance, repair, equipment modifications (if any) and the results of relevant tests carried out is to be available for the shipside HVSC-System.

8 TAS

8.1 Annual survey

8.1.1 (1/7/2013)

The Owner or his representative is to declare to the attending Surveyor that no significant alterations of the unit's structures and geometry have been made without the prior approval of the Society and without updating the electronic format of geometry and structural data.

8.1.2 (1/7/2013)

The annual survey is to include the verification that arrangements are in place to provide prompt access to shore-based damage stability and residual structural strength computerized calculation programs.

9 ARS

9.1 Annual survey

9.1.1 (1/1/2023)

The Owner or his representative is to declare to the attending Surveyor that no significant alterations have been made without the prior approval of the Society.

9.1.2 (1/1/2023)

The survey is to include the check of the following documentation and of the consistency of data recorded thereto:

- logbooks, operating and storagerecords
- motion sensors reports (in case relevant equipment is fitted)
- risk assessment and relevant update reflecting possible modification (If any)
- records for filling of cargotanks.

9.1.3 (1/1/2023)

The survey is to include:

- verifications of items covered by the cargo tank inspection plan for the annual survey scope
- a general examination of sensors/alarms aimed to verify their satisfactory conditions
- a functional test of all systems which may be performed by spot check method.

9.1.4 (1/1/2023)

Gas detection readings and records of the cargo containment system are to be checked. For membrane cargo containment systems, the gas concentration in the inter-barrier space is to be kept within acceptable limits when the system is automatically operated without forced nitrogen sweeping.

9.1.5 (1/1/2023)

The N₂ consumption readings and records of the cargo containment system are to be checked. Abnormal consumption may indicate leakages.

9.1.6 (1/1/2023)

Temperature sensor records are to be checked to find potential cold spots and leakages.

9.1.7 (1/1/2023)

For units with motion sensors, the records of the motion sensors are to be checked and confirmed below threshold values included in the cargo tank inspection plan. If records are above the threshold values, special considerations are to be made on a case-by-case basis.

9.2 Renewal survey

9.2.1 (1/1/2023)

The requirements given in [9.1] for annual survey are to be complied with. Additionally, the following examinations and tests are to be carried out in lieu of internal inspection of cargo tanks requested in Ch 4, Sec 4, [7.2.1].

9.2.2 (1/1/2023)

The survey is to include verifications of items covered by the cargo tank inspection plan for the renewal survey scope.

9.2.3 (1/1/2023)

For independent cargo tanks other than type B, a non-destructive testing (NDT) - increased with respect to the NDT required in Ch 4, Sec 4, [7.2] based on the system designer's recommendations - is to be carried out to confirm cargo tank integrity.

9.2.4 (1/1/2023)

For type B independent cargo tanks, the NDT survey is to be carried out as required in Ch 4, Sec 4, [7.2].

9.2.5 (1/1/2023)

For type B (Moss type) independent cargo tanks, the effectiveness of the primary barrier is to be confirmed by checking the gas detection readings and records taken in the annular space.

9.2.6 (1/1/2023)

The effectiveness of the secondary barrier is to be confirmed by:

- a global vacuum test in aerated or gassed up condition, or
- a thermographic test, or
- other test method acceptable to the Society.

The tests are to be carried out in accordance with procedures and acceptance criteria developed by the system designer.

9.2.7 (1/1/2023)

When the cargo tanks are subject to internal inspections as per the cargo tank inspection plan, the inspections are to include:

- full visual internal inspection of the cargo tank
- NDT of all critical welds on pump tower, including supports for upper and lower parts
- other items requested to be checked by the cargo tank inspection plan.

9.2.8 (1/1/2023)

In case of abnormal test results or damages and deformations observed during internal inspections of selected cargo tanks specified in the cargo tank inspection plan, internal cargo tank survey requirements in Ch 4, Sec 4, [7.2] apply.